

ATTENTION
OBSERVE PRECAUTIONS
FOR HANDLING
ELECTROSTATIC
DISCHARGE
SENSITIVE
DEVICES

1、Features/特征:

- Emitting Color/发光颜色: Blue
- Lens Type/封装特性: Water Clear
- Device Outline/外形特征: 3.2×1.6×1.1mm
- Dice material/晶片材质: InGaN

2、Applications/应用:

- Backlight for Mobile, Machine Vision, LCD Display/手机、电话、显示屏背光源
- Backlight in Dashboard and switch of Automotive/汽车仪表盘、记程器背光源

3、Outline Dimensions/产品外形尺寸:

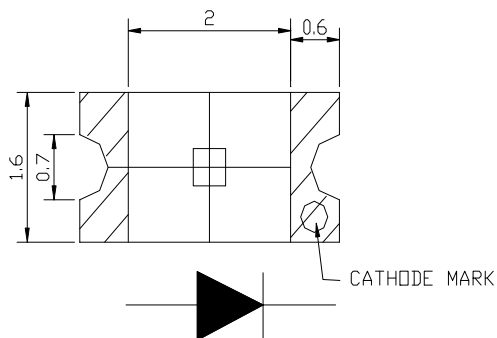
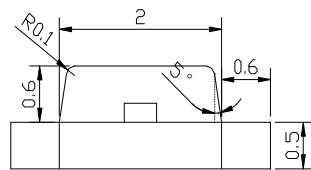
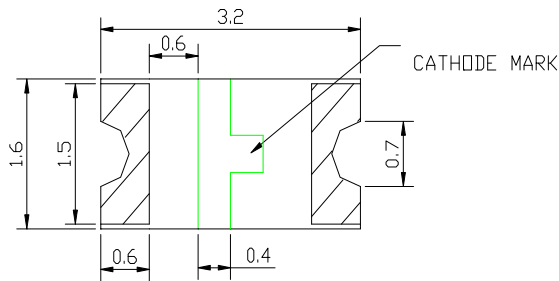

被推荐的回焊焊盘尺寸:

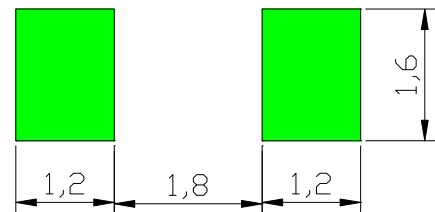

SPATIAL DISTRIBUTION

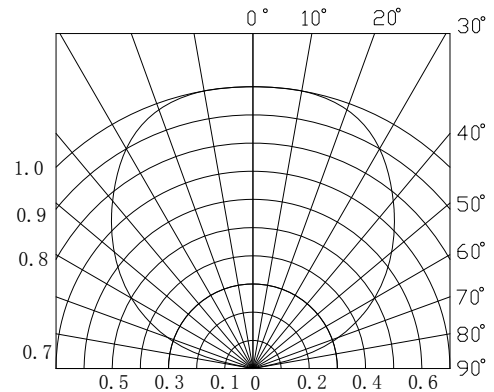

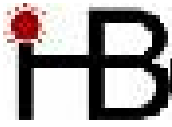

4、 Absolute maximum ratings/极限参数 (Ta = 25℃)

Parameter 参数	Symbol 符号	Test Condition 测试条件	Value 参数		Unit 单位
			Min.	Max.	
Power Dissipation 损耗功率	Pd	—	—	70	mW
Reverse Voltage 反向电压	VR	IR = 30 μ A	5	—	V
Pulse Current 正向峰值电流	IFp	Duty=0.1, 1kHz	—	100	mA
Forward Current 正向工作电流	IFm	—	—	20	mA
Operating Temperature 工作温度范围	Topr	—	-20	+85	℃
Storage Temperature 储存温度范围	Tstr	—	-25	+85	℃

5、 Electrical and optical characteristics/光电参数 (Ta = 25℃)

Parameter 参数	Symbol 符号	Test Condition 测试条件	Value 参数			Unit 单位
			Min.	Typ.	Max.	
Forward Voltage 正向电压	VF	IF =20mA	—	3.2	3.5	V
Reverse Current 反向电流	IR	VR=5V	—	—	30	μ A
Dominate Wavelength 主波长	λ d	IF=20mA	—	470	—	nm
Peak Wavelength 峰值波长	λ p	IF=20mA	—	468	—	nm
Spectral Line half-width 半波宽度	Δ λ	IF=20mA	—	20	—	nm
Luminous Intensity 发光强度	IV	IF=20mA	—	80	—	mcd
Viewing Angle 发光指向角	2 θ 1/2	IF=20mA	—	120	—	Deg.

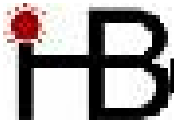

7、Typical electrical/optical characteristic curves/

光电特性曲线:

