

PLEASE CHECK WWW.MOLEX.COM FOR LATEST PART INFORMATION

Part Number: [0741395540](#)
Status: **Active**
Description: 1.27mm (.050") Pitch EBBI™ 50D Plug, Surface Mount, Vertical, with Latch, 40 Circuits, 3.00mm (.118") Retention Clip

Documents:

[3D Model](#) [Product Specification PS-71660 \(PDF\)](#)
[Drawing \(PDF\)](#) [RoHS Certificate of Compliance \(PDF\)](#)

General

Product Family PCB Headers
 Series [74139](#)
 Application Board-to-Board, Wire-to-Board
 Product Name EBBI™

Physical

Breakaway No
 Circuits (Loaded) 40
 Circuits (maximum) 40
 Color - Resin Black
 Durability (mating cycles max) 500
 Glow-Wire Compliant No
 Lock to Mating Part Yes
 Material - Metal Brass, Phosphor Bronze
 Material - Plating Mating Gold
 Material - Plating Termination Tin
 Material - Resin High Temperature Thermoplastic
 Number of Rows 2
 Orientation Vertical
 PCB Locator Yes
 PCB Retention Yes
 PCB Thickness Recommended (in) 0.062 In
 PCB Thickness Recommended (mm) 1.60 mm
 Packaging Type Tray
 Pitch - Mating Interface (in) 0.050 In
 Pitch - Mating Interface (mm) 1.27 mm
 Plating min: Mating (µin) 30
 Plating min: Mating (µm) 0.75
 Plating min: Termination (µin) 50
 Plating min: Termination (µm) 1.25
 Polarized to Mating Part Yes
 Shrouded Fully
 Stackable No
 Temperature Range - Operating -40°C to +105°C
 Termination Interface: Style Through Hole

Electrical

Current - Maximum per Contact 1A
 Voltage - Maximum 30V

Solder Process Data

Duration at Max. Process Temperature (seconds) 40
 Lead-free Process Capability Reflow Capable (SMT only)
 Max. Cycles at Max. Process Temperature 3
 Process Temperature max. C 260

Material Info

EU RoHS
ELV and RoHS
Compliant
REACH SVHC
 Not Reviewed
Halogen-Free
Status
Not Reviewed

China RoHS



Need more information on product environmental compliance?

Email productcompliance@molex.com
 For a multiple part number RoHS Certificate of Compliance, [click here](#)

Please visit the [Contact Us](#) section for any non-product compliance questions.

Search Parts in this Series

[74139Series](#)

Mates With

[71660 Vertical](#), [87552 Right Angle](#)

Reference - Drawing Numbers

Product Specification
Sales Drawing

PS-71660
SD-74139-002

This document was generated on 04/21/2010

PLEASE CHECK WWW.MOLEX.COM FOR LATEST PART INFORMATION

NOTES:

- 1) MATERIALS:
HOUSING: GLASS-FILLED LCP (LIQUID CRYSTAL POLYMER)
UL 94 V 0, BLACK
TERMINALS: BRASS
BOARD LOCKS: PHOSPHOR BRONZE
METAL LATCHES: 302 STAINLESS STEEL.
- 2) FINISH:
TERMINALS:
.000030/(0.00076) MINIMUM GOLD IN CONTACT AREA AND
.000050/(0.00127) MINIMUM TIN IN TAIL AREA OVER
.000075/(0.00191) MINIMUM NICKEL UNDERPLATING OVERALL.
BOARD LOCKS:
.000050/(0.00127) MINIMUM TIN
- 3) ASSEMBLY MATES WITH MOLEX P/N SDA-71660-****,
CONFORMS TO PRODUCT SPECIFICATION PS-71660.
- 4) FOUR DIGIT DATE CODE (WK, YR), EXAMPLE => 26 96
LOCATED IN AREA INDICATED.

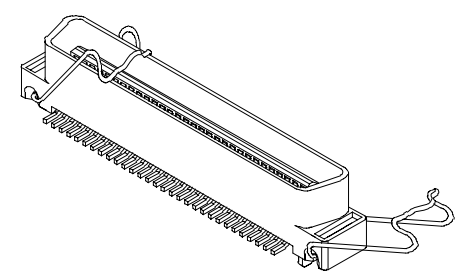
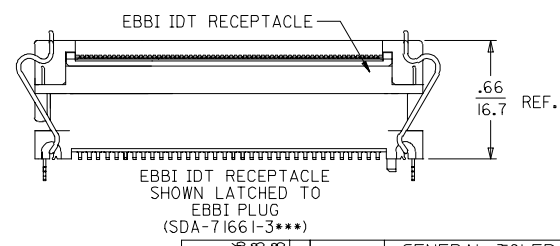
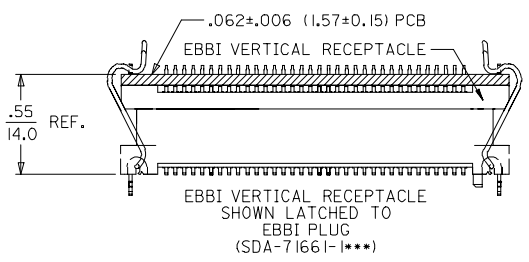
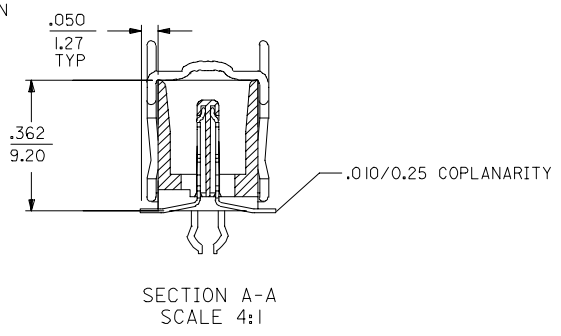
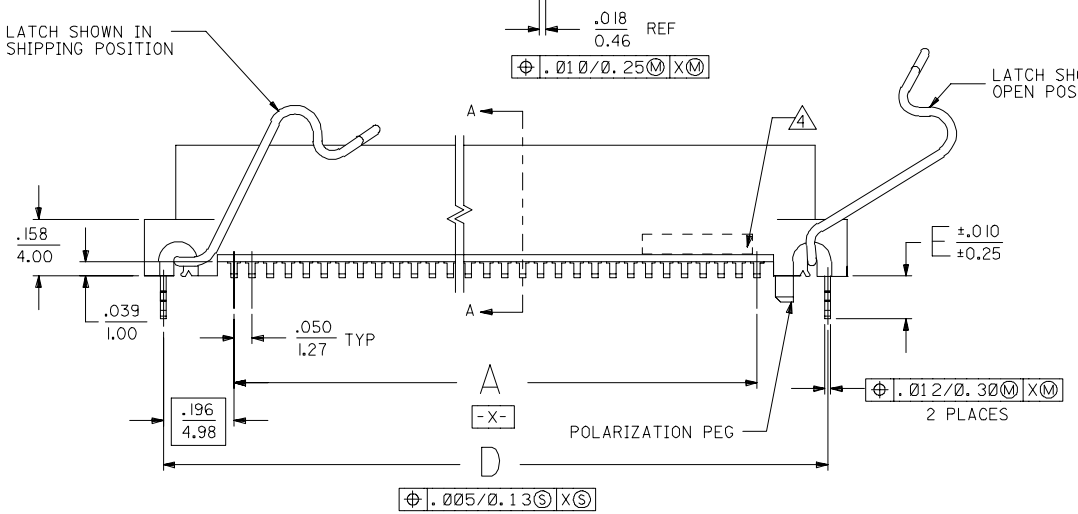
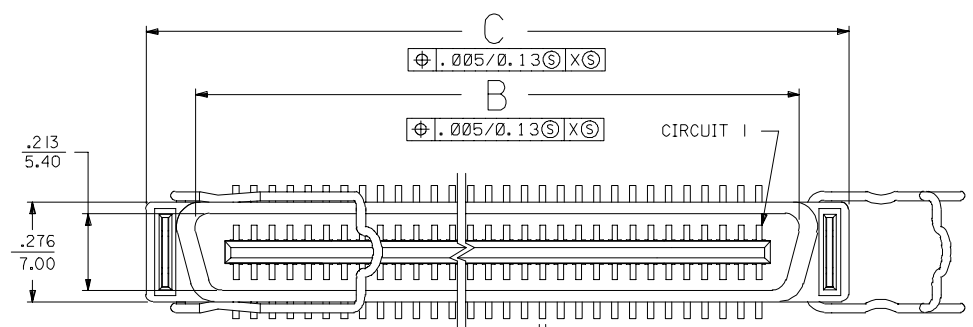

REFERENCE APPLICATION VIEWS

ADD -5540 FC NO: UCP2008-0028 DRAWN: BBARKER CHKD: 2007/08/08 APPR: SMILLER 2007/08/08	DESCRIPTION REV	QUALITY SYMBOLS	GENERAL TOLERANCES (UNLESS SPECIFIED)	DIMENSION STYLE	SCALE	DESIGN UNITS	THIRD ANGLE PROJECTION
		$\nabla=0$ $\nabla=0$	mm INCH 4 PLACES ± --- ± --- 3 PLACES ± --- ± .005 2 PLACES ± 0.13 ± .01 1 PLACE ± 0.25 ± --- ANGULAR ±1/2°	IN/MM DRAWN BY BSMART CHECKED BY BBARKER APPROVED BY SMILLER DATE 01/20/2005 DATE 01/20/2005 DATE 01/20/2005	1:1	INCH	TITLE SALES ASSY EBBI 50D VERT SMT PLUG-WITH LATCHES, NO VAC CAP
		DRAFT WHERE APPLICABLE MUST REMAIN WITHIN DIMENSIONS	SEE TABLE SIZE C	MATERIAL NO. DOCUMENT NO. SD-74139-002	MOLEX INCORPORATED		
		SHEET NO. 1 OF 2					

2	D
1	D
SHT	REV

MATERIAL NUMBER	CKT	A	B	C	D	E	PCB THICKNESS	PACKAGING SPEC.
74139-5530	30	.700 (17.78)	.926 (23.52)	1.199 (30.45)	1.092 (27.74)	.118 (3.00)	.062 (1.57)±.006 (0.15)	PK-70873-055
74139-5540	40	.950 (24.13)	1.176 (29.87)	1.449 (36.80)	1.342 (34.09)	.118 (3.00)	.062 (1.57)±.006 (0.15)	PK-70873-055
74139-5660	60	1.450 (36.83)	1.676 (42.57)	1.949 (49.50)	1.842 (46.79)	.118 (3.00)	.062 (1.57)±.006 (0.15)	PK-70873-055
74139-5568	68	1.650 (41.91)	1.876 (47.65)	2.149 (54.58)	2.042 (51.88)	.118 (3.00)	.062 (1.57)±.006 (0.15)	PK-70873-055
74139-5569	68	1.650 (41.91)	1.876 (47.65)	2.149 (54.58)	2.042 (51.88)	.172 (4.37)	.116 (2.95)±.006 (0.15)	PK-70873-055
74139-5600	100	2.450 (62.23)	2.676 (67.97)	2.949 (74.90)	2.842 (72.19)	.118 (3.00)	.062 (1.57)±.006 (0.15)	PK-70873-055

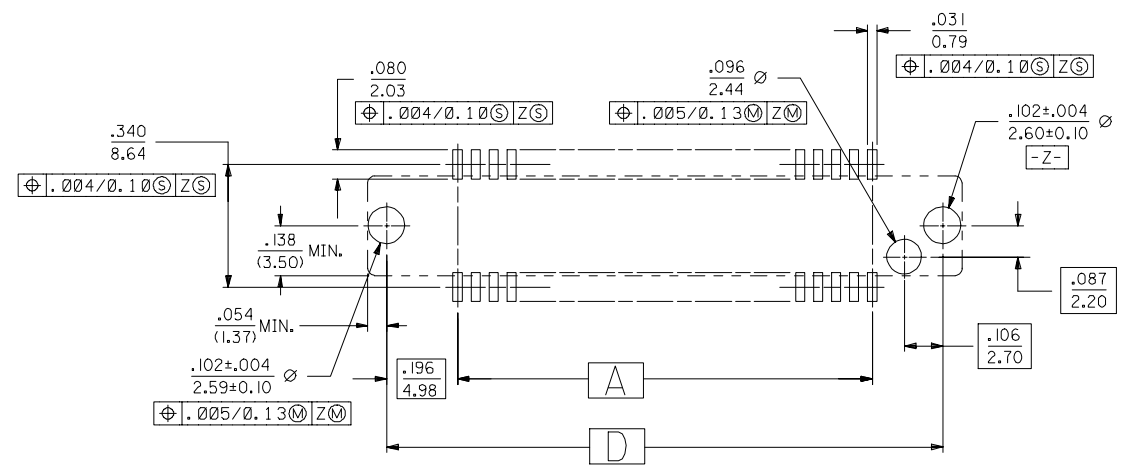
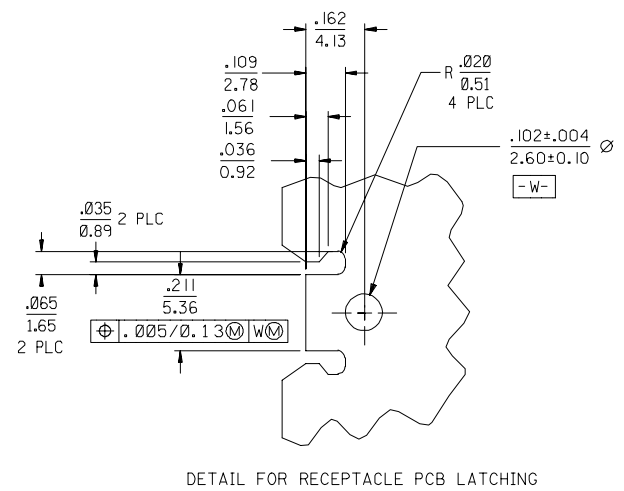

PCB LAYOUT: COMPONENT SIDE
SEE TABLE FOR RECOMMENDED PCB THICKNESS

ADD -5540 FC NO: UICP2008-0028 DRAWN BY: BBARKER 2007/08/06 CHKD: SDANNELLEY 2007/08/08 APPR: SMILLER 2007/08/08 REVISIONS:	QUALITY SYMBOLS	GENERAL TOLERANCES (UNLESS SPECIFIED)	DIMENSION STYLE	SCALE	DESIGN UNITS	THIRD ANGLE PROJECTION
	▽=0 ▽=0	mm INCH 4 PLACES ± --- ± --- 3 PLACES ± --- ±.005 2 PLACES ± 0.13 ±.01 1 PLACE ± 0.25 ± --- ANGULAR ±1/2°	IN/MM	4:1	INCH	◎ □ THIRD ANGLE PROJECTION
	DRAFT WHERE APPLICABLE MUST REMAIN WITHIN DIMENSIONS	DRAWN BY: BSMART 01/20/2005 CHECKED BY: BBARKER 01/20/2005 APPROVED BY: SMILLER 01/20/2005 MATERIAL NO. SEE TABLE SIZE C	DATE: 01/20/2005 DATE: 01/20/2005 DATE: 01/20/2005	TITLE: SALES ASSY EBBI 50D VERT SMT PLUG-WITH LATCHES, NO VAC CAP MOLEX INCORPORATED DOCUMENT NO. SD-74139-002 SHEET NO. 2 OF 2		
	THIS DRAWING CONTAINS INFORMATION THAT IS PROPRIETARY TO MOLEX INCORPORATED AND SHOULD NOT BE USED WITHOUT WRITTEN PERMISSION					