

PLEASE CHECK WWW.MOLEX.COM FOR LATEST PART INFORMATION

Part Number: [0716611568](#)
Status: **Active**
Overview: [ebbi_50d](#)
Description: 1.27mm (.050") Pitch EBBI™ 50D Plug, Vertical, with Latch, 68 Circuits, 2.79mm (.110") PC Tail Length

Documents:

[3D Model](#) [RoHS Certificate of Compliance \(PDF\)](#)
[Drawing \(PDF\)](#)

Agency Certification

CSA LR19980
 UL E29179

General

Product Family PCB Headers
 Series [71661](#)
 Application Board-to-Board, Wire-to-Board
 Overview [ebbi_50d](#)
 Product Name EBBI™

Physical

Breakaway No
 Circuits (Loaded) 68
 Circuits (maximum) 68
 Color - Resin Black
 Durability (mating cycles max) 2,000
 First Mate / Last Break No
 Flammability 94V-0
 Glow-Wire Compliant No
 Guide to Mating Part No
 Keying to Mating Part None
 Lock to Mating Part Yes
 Material - Metal Copper Alloy
 Material - Plating Mating Gold
 Material - Plating Termination Tin
 Material - Resin High Temperature Thermoplastic
 Number of Rows 4
 Orientation Vertical
 PC Tail Length (in) 0.110 In
 PC Tail Length (mm) 2.79 mm
 PCB Locator Yes
 PCB Retention Yes
 PCB Thickness Recommended (in) 0.062 In
 PCB Thickness Recommended (mm) 1.60 mm
 Packaging Type Tray
 Pitch - Mating Interface (in) 0.050 In
 Pitch - Mating Interface (mm) 1.27 mm
 Pitch - Term. Interface (in) 0.050 In
 Pitch - Term. Interface (mm) 1.27 mm
 Plating min: Mating (µin) 30
 Plating min: Mating (µm) 0.76
 Plating min: Termination (µin) 75
 Plating min: Termination (µm) 1.91
 Polarized to Mating Part Yes
 Polarized to PCB Yes

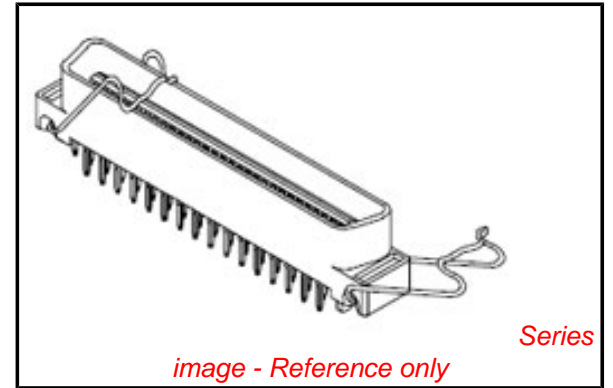

image - Reference only

EU RoHS

ELV and RoHS Compliant
REACH SVHC
 Not Reviewed
Halogen-Free Status
Not Reviewed

China RoHS



Need more information on product environmental compliance?

Email productcompliance@molex.com
 For a multiple part number RoHS Certificate of Compliance, [click here](#)

Please visit the [Contact Us](#) section for any non-product compliance questions.

Search Parts in this Series

[71661Series](#)

Mates With

EBBI™ 50D Receptacle [71660](#) , [87552](#)

Shrouded	Fully
Stackable	No
Surface Mount Compatible (SMC)	No
Temperature Range - Operating	-40°C to +105°C
Termination Interface: Style	Through Hole

Electrical

Current - Maximum per Contact	1A
Voltage - Maximum	30V

Solder Process Data

Lead-free Process Capability	SMC & Wave Capable (TH only)
Process Temperature max. C	260

Material Info**Reference - Drawing Numbers**

Packaging Specification	PK-70873-084*
Sales Drawing	SDA-71661-15**

This document was generated on 05/31/2010

PLEASE CHECK WWW.MOLEX.COM FOR LATEST PART INFORMATION

13 12 11 10 9 8 7 6 5 4 3 2 1

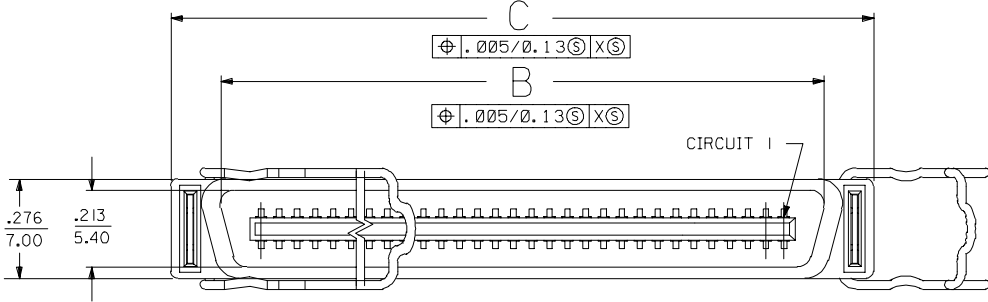

NOTES:

- 1) MATERIALS:
 HOUSING - LIQUID CRYSTAL POLYMER (LCP), GLASS FILLED, UL94V-0, COLOR: BLACK
 TERMINALS - COPPER ALLOY
 METAL PEGS - COPPER ALLOY
 METAL LATCHES - STAINLESS STEEL.
 - 2) PLATING:
 TERMINALS:
 30 MICROINCH/0.76 MICROMETER MINIMUM GOLD IN CONTACT AREA AND 50 MICROINCH/1.27 MICROMETER MINIMUM TIN IN TAIL AREA OVER NICKEL UNDERPLATING OVERALL.
 METAL PEGS:
 50 MICROINCHES/1.27 MICROMETER MINIMUM TIN
 - 3) ASSEMBLY MATES WITH MOLEX P/N 71660-****. CONFORMS TO PRODUCT SPECIFICATION PS-71660.
- ▲ RECOMMENDED P.C. BOARD THICKNESS IS .062 (1.6).
- ▲ FOUR DIGIT DATE CODE (WK YR), EXAMPLE => 26 96 LOCATED IN AREA INDICATED.

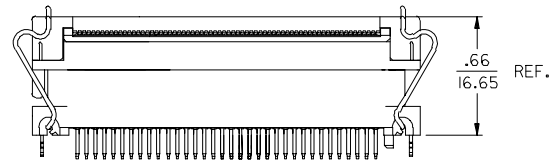
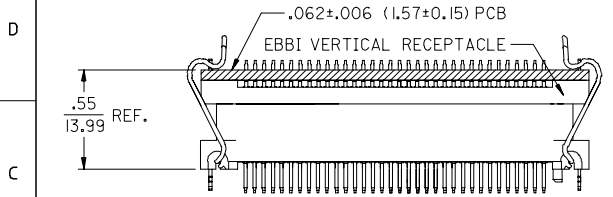
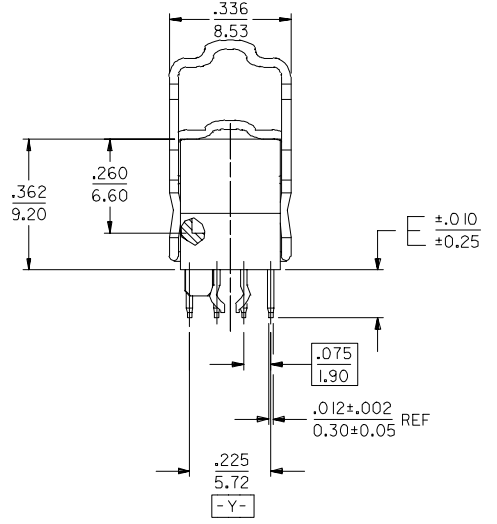
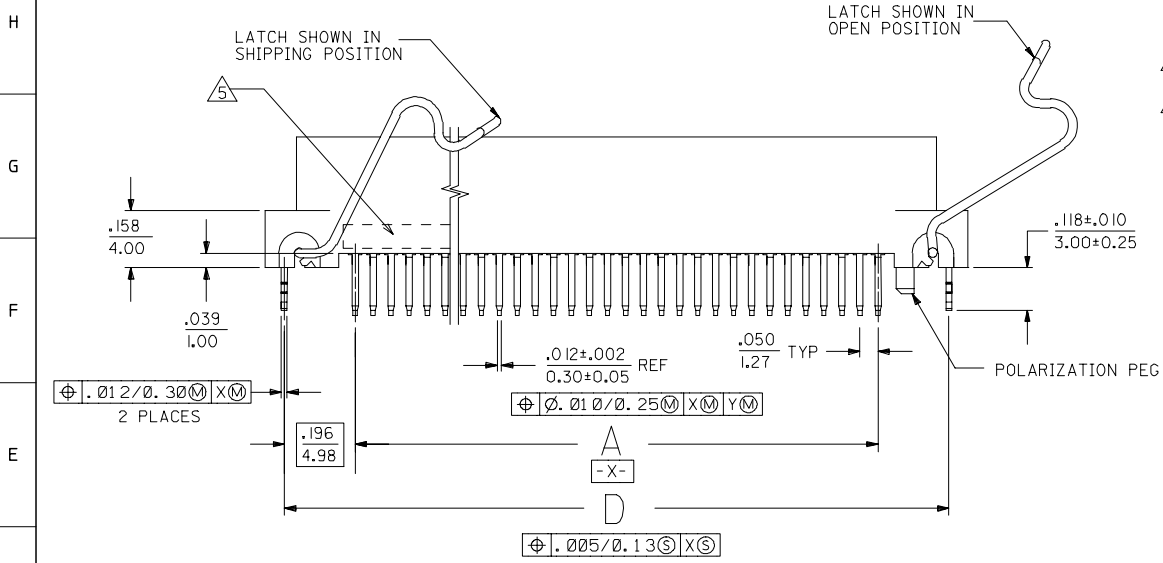

EBBI VERTICAL RECEPTACLE SHOWN LATCHED TO EBBI PLUG (SDA-71660-3***)

EBBI IDT RECEPTACLE SHOWN LATCHED TO EBBI PLUG (SDA-71660-3***)

REFERENCE APPLICATION VIEWS

NOTE FOR LEAD FREE CONVERSION:
 THE PRIMARY SHIPPING CARTON WILL BE LABELED "COMPLIANT TO ROHS DIRECTIVE 2002/95/EC AND ELV ANNEX II OF DIRECTIVE 2000/53/EC". CARTONS WITHOUT THIS LABEL MAY CONTAIN PRODUCT WITH LEAD.

2	C
1	C
SHT	REV

CHG LATCH GEO FC NO: UCP2005-2042 2005/07/19 DRAWNSMART 2005/07/19 CHKD:BBARKER APPR:SMILLER 2005/07/20	QUALITY SYMBOLS	GENERAL TOLERANCES (UNLESS SPECIFIED)	DIMENSION STYLE	SCALE	DESIGN UNITS	THIRD ANGLE PROJECTION
	$\nabla=0$ $\nabla=0$	mm INCH 4 PLACES ± --- ± --- 3 PLACES ± --- ± .005 2 PLACES ± 0.13 ± .01 1 PLACE ± 0.25 ± --- ANGULAR ±1/2°	IN/MM DRAWN BY DATE DGA 09/15/2005 CHECKED BY DATE RAN 09/15/2005 APPROVED BY DATE GWF 09/15/2005	4:1	INCH	TITLE SALES ASSEMBLY MOLEX EBBI 50D VERT PLUG WITH BAIL LATCHES MOLEX MOLEX INCORPORATED
	MATERIAL NO. SEE TABLE	SHEET NO. 1 OF 2	THIS DRAWING CONTAINS INFORMATION THAT IS PROPRIETARY TO MOLEX INCORPORATED AND SHOULD NOT BE USED WITHOUT WRITTEN PERMISSION			
	DRAFT WHERE APPLICABLE MUST REMAIN WITHIN DIMENSIONS		SDA-71661-15**			

12 11 10 9 8 7 6 5 4 3 2 1

13 12 11 10 9 8 7 6 5 4 3 2 1

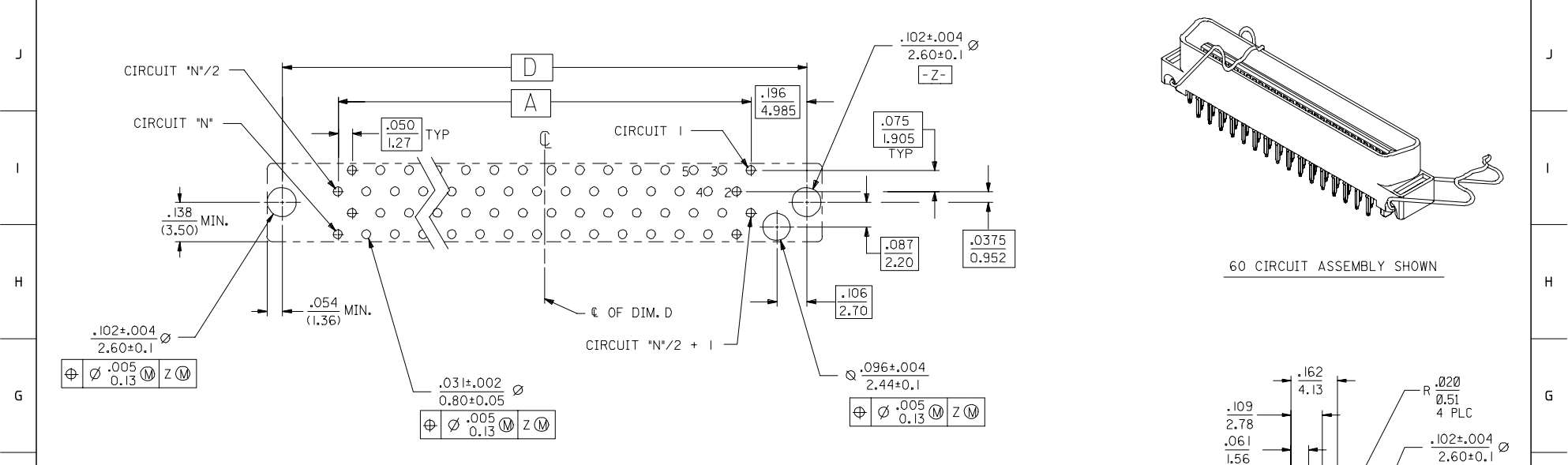

RECOMMENDED PC BOARD LAYOUT COMPONENT SIDE

60 CIRCUIT ASSEMBLY SHOWN

DETAIL FOR RECEPTACLE PCB LATCHING

	.134 (3.40)	2.042 (51.88)	2.149 (54.58)	1.875 (47.65)	1.650 (41.91)	68	71661-1569	PK-70873-0845
	.134 (3.40)	1.842 (46.80)	1.949 (49.50)	1.676 (42.57)	1.450 (36.83)	60	71661-1561	PK-70873-0845
	.110 (2.79)	2.342 (59.50)	2.449 (62.20)	2.176 (55.27)	1.950 (49.53)	80	71661-1580	PK-70873-0846
	.110 (2.79)	2.042 (51.88)	2.149 (54.58)	1.875 (47.65)	1.650 (41.91)	68	71661-1568	PK-70873-0845
C	.110 (2.79)	1.842 (46.80)	1.949 (49.50)	1.676 (42.57)	1.450 (36.83)	60	71661-1560	PK-70873-0845
	.110 (2.79)	1.092 (27.75)	1.199 (30.45)	.925 (23.52)	.700 (17.78)	30	71661-1530	PK-70873-0840
	E	D	C	B	A	CKT ("N")	MATERIAL NUMBER	PACKAGING SPECIFICATION

CHG ISO GEOMETRY FC NO: UCP2005-2042 DRAWNSMART 2005/07/19 CHKD:BBARKER 2005/07/19 APPR:SMILLER 2005/07/20 REV DESCRIPTION	QUALITY SYMBOLS ▽=0 ▽=0	GENERAL TOLERANCES (UNLESS SPECIFIED) mm INCH 4 PLACES ±.005 ±.005 3 PLACES ±.01 ±.005 2 PLACES ±0.13 ±.01 1 PLACE ±0.25 ±.01 ANGULAR ±1/2°	DIMENSION STYLE ECN/MML PCB LATCHING DRAWN BY DATE DGA 09/15/1996 CHECKED BY DATE RAN 09/15/1996 APPROVED BY DATE GWF 09/15/1996	SCALE 1:1 DESIGN UNITS INCH THIRD ANGLE PROJECTION	TITLE SALES ASSEMBLY MOLEX EBBI 50D VERT PLUG WITH BAIL LATCHES MOLEX INCORPORATED	MATERIAL NO. SEE TABLE DOCUMENT NO. SDA-71661-15** SHEET NO. 2 OF 2
	DRAFT WHERE APPLICABLE MUST REMAIN WITHIN DIMENSIONS			THIS DRAWING CONTAINS INFORMATION THAT IS PROPRIETARY TO MOLEX INCORPORATED AND SHOULD NOT BE USED WITHOUT WRITTEN PERMISSION		
				MOLEX INCORPORATED		
				SDA-71661-15**		

12 11 10 9 8 7 6 5 4 3 2 1