

**PLEASE CHECK WWW.MOLEX.COM FOR LATEST PART INFORMATION**

**Part Number:** [0345661703](#)  
**Status:** **Active**  
**Overview:** [mx123 sealed connection systems](#)  
**Description:** 2.54mm (.100") Pitch, MX123 Female Receptacle Housing, Keying Option E, Wire Dress Option 9, 73 Circuits, Green TPA

**Documents:**

[Drawing \(PDF\)](#) [RoHS Certificate of Compliance \(PDF\)](#)  
[Product Specification PS-34566-0000 \(PDF\)](#)

**General**

Product Family	Crimp Housings
Series	<a href="#">34566</a>
Comments	See Sales Drawing for number of Open Circuits
Overview	<a href="#">mx123 sealed connection systems</a>
Product Name	MX123

**Physical**

Circuits (maximum)	73
Circuits Detail	73
Color - Resin	Green
Gender	Female
Glow-Wire Compliant	No
Keying to Mating Part	Yes
Lock to Mating Part	Yes
Material - Resin	Nylon
Number of Rows	4
Packaging Type	Tray
Panel Mount	No
Pitch - Mating Interface (in)	0.100 In
Pitch - Mating Interface (mm)	2.54 mm
Pitch - Term. Interface (in)	0.100 In
Pitch - Term. Interface (mm)	2.54 mm
Polarized to Mating Part	Yes
Stackable	No
Temperature Range - Operating	-40°C to +125°C

**Electrical**

Current - Maximum per Contact	11A, 25A
-------------------------------	----------

**Material Info**

**Reference - Drawing Numbers**

Application Specification	AS-34566-001
Product Specification	PS-34566-0000

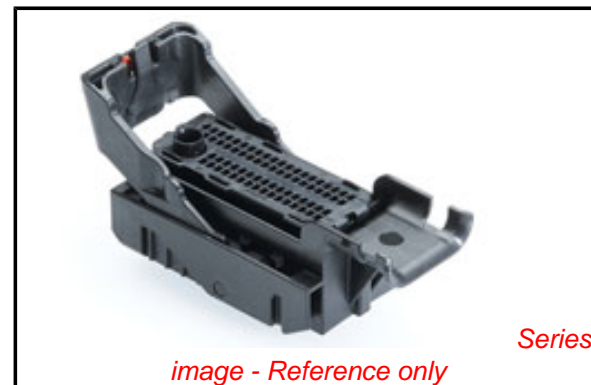

**EU RoHS**

**ELV and RoHS Compliant**  
**REACH SVHC**  
 Not Reviewed  
**Halogen-Free**  
**Status**  
**Not Reviewed**

**China RoHS**



**Need more information on product environmental compliance?**

Email [productcompliance@molex.com](mailto:productcompliance@molex.com)  
 For a multiple part number RoHS Certificate of Compliance, [click here](#)

Please visit the [Contact Us](#) section for any non-product compliance questions.

**Search Parts in this Series**

[34566Series](#)

**Mates With**

MX123 Female Header [31386](#) , [31387](#)

**Use With**

MX64 Female Terminals [33467](#)

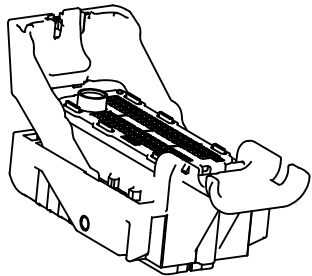

73 CKT  
SCALE 3:2

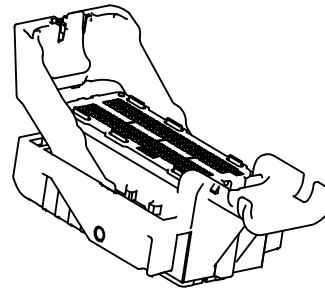
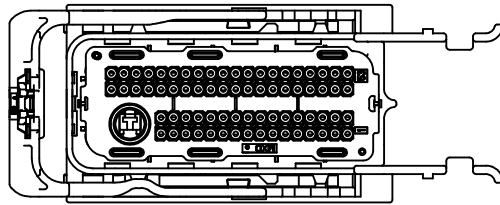

80 CKT  
SCALE 3:2

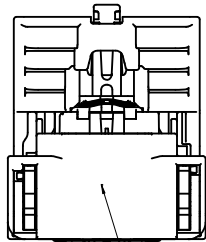

RECOMMENDED LOCATION  
FOR NOTE 2D

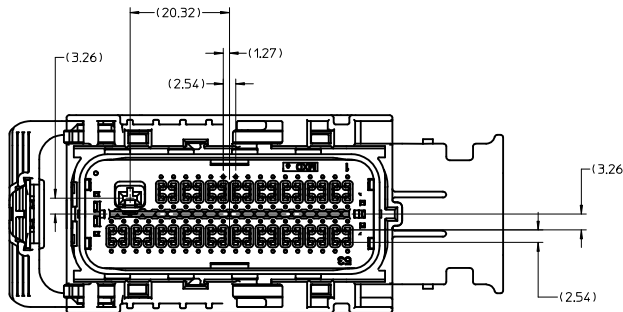
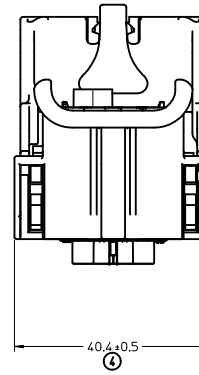
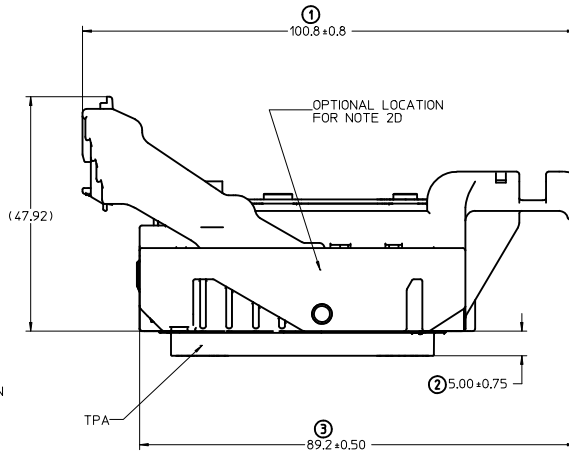

NOTES: UNLESS OTHERWISE SPECIFIED

1. MATERIAL:

- A. RESIN: SEE COMPONENT DRAWINGS
- B. COLOR: SEE TABLE

2. DESIGN - GENERAL:

- A. THIS IS A 100% CAD GENERATED PART. THE CAD MATHEMATICAL DATA IS THE MASTER FOR THIS PART. FOR DIMENSIONAL OR ANY INFORMATION NOT SHOWN ON THIS DRAWING, ANALYZE THE CAD MODEL.
- B. TOLERANCES:
  - a. LINEAR XX ± 0.30
  - XXX ± 0.10
  - XXXX ± 0.10
  - b. ANGULAR X° ± 3.0°
- C. CORNERS SHOWN AS SHARP TO BE R 0.2 MAX.
- D. FOLLOWING PRODUCTION CODES TO BE PERMANENTLY MARKED & HUMAN READABLE TO A LETTER HEIGHT < 3mm.
  - LINE #1: MATERIAL #:
  - LINE #2: DATE CODE: JJYY (JULIAN DAY, LAST DIGIT OF YEAR)
  - LINE #3: INSPECTION MACHINE CODE #
  - LINE #4: SERIAL #X\_XXXX
- E-1. PARTS MUST BE FREE OF DISCOLORATION, SALT RESIDUE AND OTHER IMPERFECTIONS THAT AFFECT FIT OR FUNCTION.
- E-2. SCRATCHES OR DENTS NOT TO EXCEED 0.10mm IN DEPTH.
- F. CHANGES IN DESIGN FROM PART PREVIOUSLY APPROVED REQUIRES PRIOR ENGINEERING APPROVAL. THIS INCLUDES BUT IS NOT LIMITED TO DRAFT, MATERIAL OR PROCESSING.
- G. SHALL CONFORM TO THE FOLLOWING PACKAGING SPECIFICATION 300-019

3. DESIGN - MANUFACTURING:

- A. DRAFT TO BE WITHIN TOLERANCE.
- B. ALLOWABLE FLASH 0.2 MAX HIGH X 0.13 MAX THICK.
- C. ALLOWABLE PARTING LINE MISMATCH 0.2 MAX.
- D. EJECTOR PINS MARK TO BE FLUSH TO 0.25 MAX DEPRESSED.
- E. ALLOWABLE GATE VESTIGE TO BE FLUSH TO 0.25 MAX PROTRUSION.

4. SYSTEM REQUIREMENTS:

WHEN TESTED TO SAE/USCAR-2 REV. 3, APRIL 2001, AND GMW #3191, AUGUST 22, 2000 (DRAFT).

- A. TPA (WITHOUT TERMINALS)
  - a. INSERTION FORCE FROM PRE-SET TO LOCK: ≥20
  - b. REMOVAL FORCE FROM PRE-SET: ≥20
- B. CPA
  - a. INSERTION FORCE FROM PRE-SET TO LOCK WITH CONNECTOR UN-MATED: ≥60N
  - b. REMOVAL FORCE FROM PRE-SET: ≥30N
- C. GROMMET CAP
  - a. REMOVAL FORCE FROM HOUSING WITH ENGAGED LATCHES: ≥110N
- D. MATE ASSIST LEVER
  - a. INADVERTENT ACTUATION FORCE DURING SHIPPING, HANDLING OR PRE-ASSEMBLY: ≥190N

F40	REVISED DRAWING---CIRCUIT 73 IS OPEN ON MATERIAL NUMBER 34566-2983
F39	ADD PART NUMBERS
F38	ADD PART NUMBERS
F37	ADD PART NUMBERS
F36	ADD PART NUMBERS
F35	ADD PART NUMBERS
F34	ADD PART NUMBERS
F33	ADD PART NUMBERS
F32	ADD PART NUMBERS & SHEET 33
F31	ADD PART NUMBERS
F30	ASSY # 34566-2683---KEY OPT H WAS A. COLOR ST BRY WAS BLACK
F29	ADD PART NUMBERS
REV	DESCRIPTION

ENTER DESCRIPTION REC NO: UAU2010-1551 DRAWN BY: 2010/03/15 CHKD BY: CHYKOR FFH 2008/05/09 APPR: VKOSHY 2010/03/18	QUALITY SYMBOLS ▽=0 ▽=0	GENERAL TOLERANCES (UNLESS SPECIFIED)		DIMENSION STYLE MM ONLY		SCALE 2:1	DESIGN UNITS METRIC	THIRD ANGLE PROJECTION		
		4 PLACES ±---+--- 3 PLACES ±---+--- 2 PLACES ±---+--- 1 PLACE ±---+---	mm INCH	DRAWN BY SRAJENDRANAT	DATE 2008/05/09	CHECKED BY TSKIVER	DATE 2008/05/09	TITLE MX123 73/80 CKT HRNS CONN ASSY		
		ANGULAR ±---°		APPROVED BY VKOSHY	DATE 2010/03/18	MATERIAL NO. SEE BOM TABLE		DOCUMENT NO. SD-34566-001	SHEET NO. 1 OF 36	
		DRAFT WHERE APPLICABLE MUST REMAIN WITHIN DIMENSIONS		THIS DRAWING CONTAINS INFORMATION THAT IS PROPRIETARY TO MOLEX INCORPORATED AND SHOULD NOT BE USED WITHOUT WRITTEN PERMISSION						

**WIRE DRESS OPTION 0**  
HOUSING ONLY, SHOWN FOR CLARITY

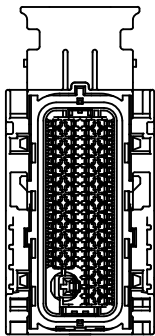

73 CKT  
KEY OPTION A

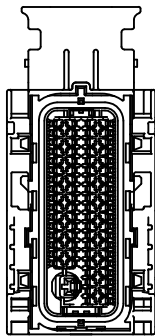

73 CKT  
KEY OPTION B

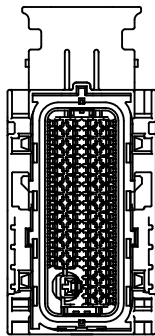

73 CKT  
KEY OPTION C

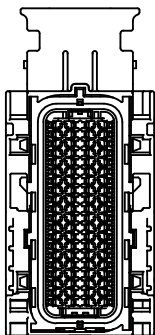

80 CKT  
KEY OPTION G

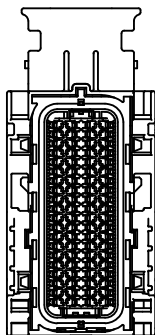

80 CKT  
KEY OPTION H

<b>ENTER DESCRIPTION</b> REC NO: UAU2010-1551 DRAWN BY: 2010/03/15 CHYKORRFF/THS 2008/05/09 APPR:VKOSHY 2010/03/18 T40 REV:	QUALITY SYMBOLS ▽=0 ▽=0	GENERAL TOLERANCES (UNLESS SPECIFIED) <table border="1"> <thead> <tr> <th></th> <th>mm</th> <th>INCH</th> </tr> </thead> <tbody> <tr> <td>4 PLACES</td> <td>±---</td> <td>±---</td> </tr> <tr> <td>3 PLACES</td> <td>±---</td> <td>±---</td> </tr> <tr> <td>2 PLACES</td> <td>±---</td> <td>±---</td> </tr> <tr> <td>1 PLACE</td> <td>±---</td> <td>±---</td> </tr> <tr> <td colspan="3">ANGULAR ±----</td> </tr> </tbody> </table>		mm	INCH	4 PLACES	±---	±---	3 PLACES	±---	±---	2 PLACES	±---	±---	1 PLACE	±---	±---	ANGULAR ±----			DIMENSION STYLE <b>MM ONLY</b>	SCALE <b>1.5:1</b>	DESIGN UNITS <b>METRIC</b>	THIRD ANGLE PROJECTION 
		mm	INCH																					
	4 PLACES	±---	±---																					
	3 PLACES	±---	±---																					
2 PLACES	±---	±---																						
1 PLACE	±---	±---																						
ANGULAR ±----																								
DRAWN BY: SRAJENDRANAT 2008/05/09 CHECKED BY: TSK IVER 2008/05/09 APPROVED BY: VKOSHY 2010/03/18		MATERIAL NO.		DOCUMENT NO.		SHEET NO.																		
DRAFT WHERE APPLICABLE MUST REMAIN WITHIN DIMENSIONS		SEE BOM TABLE		MOLEX INCORPORATED		2 OF 36																		
THIS DRAWING CONTAINS INFORMATION THAT IS PROPRIETARY TO MOLEX INCORPORATED AND SHOULD NOT BE USED WITHOUT WRITTEN PERMISSION																								

20 19 18 17 16 15 14 13 12 11 10 9 8 7 6 5 4 3 2 1

**WIRE DRESS OPTION 9**  
HOUSING ONLY, SHOWN FOR CLARITY

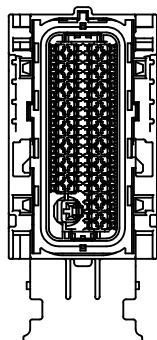

73 CKT  
KEY OPTION A

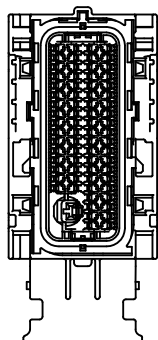

73 CKT  
KEY OPTION B

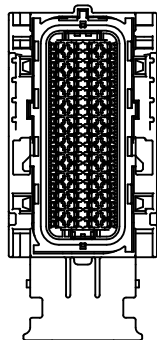

80 CKT  
KEY OPTION G

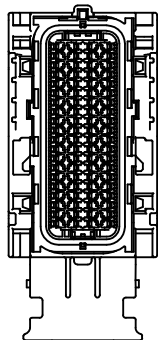

80 CKT  
KEY OPTION H

<b>ENTER DESCRIPTION</b> REC NO: UAU2010-1551 DRAWN BY: 2010/03/15 CHKD BY: FFJHS 2008/05/09 APPR: VKOSHY 2010/03/18	QUALITY SYMBOLS ▽=0 ▽=0	GENERAL TOLERANCES (UNLESS SPECIFIED) mm INCH 4 PLACES # --- # --- 3 PLACES # --- # --- 2 PLACES # --- # --- 1 PLACE # --- # --- ANGULAR ± ---°	DIMENSION STYLE <b>MM ONLY</b>	SCALE <b>1.5:1</b>	DESIGN UNITS <b>METRIC</b>	THIRD ANGLE PROJECTION	
	DRAWN BY: SRAJENDRANAT DATE: 2008/05/09	CHECKED BY: TSK IVER DATE: 2008/05/09	APPROVED BY: VKOSHY DATE: 2010/03/18	TITLE <b>MX123 73/80 CKT HRNS CONN ASSY</b>			
	DRAFT WHERE APPLICABLE MUST REMAIN WITHIN DIMENSIONS			MATERIAL NO. <b>SEE BOM TABLE</b>		DOCUMENT NO. <b>SD-34566-001</b>	
	SIZE <b>D</b>			SHEET NO. <b>3 OF 36</b> THIS DRAWING CONTAINS INFORMATION THAT IS PROPRIETARY TO MOLEX INCORPORATED AND SHOULD NOT BE USED WITHOUT WRITTEN PERMISSION			

19 18 17 16 15 14 13 12 11 10 9 8 7 6 5 4 3 2 1

WIRE DRESS OPTION 0

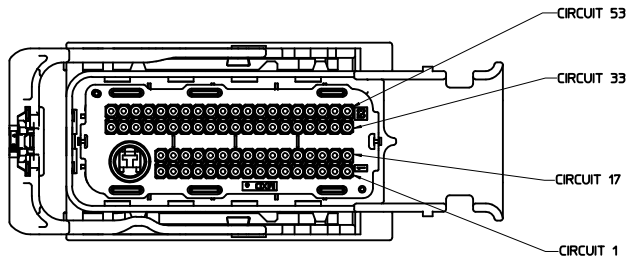

73 CKT

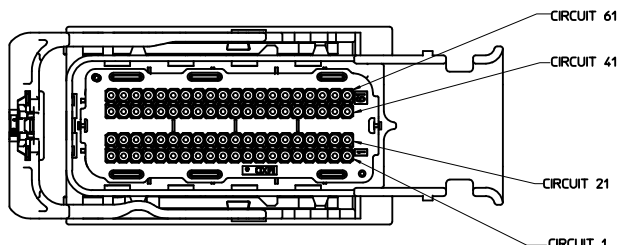

80 CKT

WIRE DRESS OPTION 9

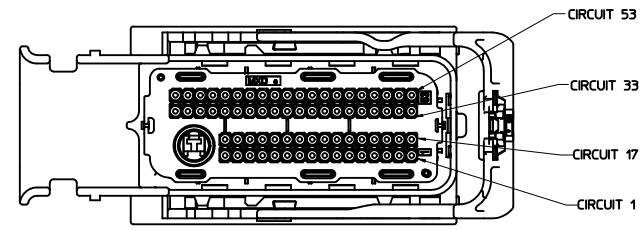

73 CKT

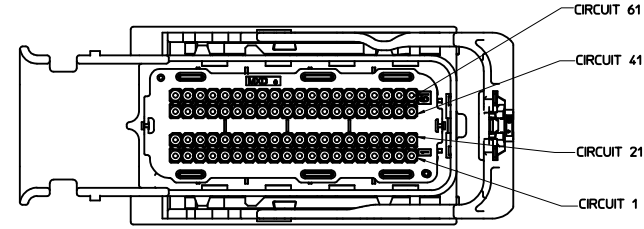

80 CKT

<b>ENTER DESCRIPTION</b> EC NO: UAU2010-1551 DRAWN BY: DRWNAH01 CHECKED BY: CHKDGRFFHIS APPROVED BY: APPR.VKOSHY DATE: 2010/03/15 DATE: 2008/05/09 DATE: 2010/03/18	<b>QUALITY SYMBOLS</b> ▽=0 ▽=0 T40	<b>GENERAL TOLERANCES (UNLESS SPECIFIED)</b>		<b>DIMENSION STYLE</b> MM ONLY	SCALE 2:1	DESIGN UNITS METRIC	THIRD ANGLE PROJECTION		
		4 PLACES ±---+--- 3 PLACES ±---+--- 2 PLACES ±---+--- 1 PLACE ±---+---	mm    INCH	DRAWN BY: SRAJENDRANAT DATE: 2008/05/09	CHECKED BY: TSKIVER DATE: 2008/05/09	TITLE MX123 73/80 CKT HRNS CONN ASSY			
		ANGULAR ±---°		APPROVED BY: VKOSHY DATE: 2010/03/18	MOLEX INCORPORATED				
		DRAFT WHERE APPLICABLE MUST REMAIN WITHIN DIMENSIONS		SEE BOM TABLE	MATERIAL NO. SD-34566-001	DOCUMENT NO.	SHEET NO. 4 OF 36		



20 19 18 17 16 15 14 13 12 11 10 9 8 7 6 5 4 3 2 1

STATUS	GM PART #	MATERIAL #	PART/MATERIAL REVISION	WIRE DRESS OPTION	KEY OPTION	COLOR (TPA)	NUMBERS INDICATE CAVITIES OPEN FOR CIRCUITS																																																																																																																																																																																																																																																																																																																																																																																																																																																																																																																																																																																																														
AVAILABLE	NOT APPLICABLE	34566-2803	G	0	H	ST GRAY	[Empty grid]																																																																																																																																																																																																																																																																																																																																																																																																																																																																																																																																																																																																														
AVAILABLE	NOT APPLICABLE	34566-2903	G	0	A	BLACK	72	71	70	69	68	67	66	64	63	62	61	59			55	54	53								52	51	49	48	47	46	44	43	42	41	39			35	34	33								73			32	31	29	27	25	23			19	18	17											16	15	14	13	12	11	9	8	7	6	5	4	3	2	1	AVAILABLE	NOT APPLICABLE	34566-3003	G	0	A	BLACK	72	71	70	69	68	67	66	64	63	62	60	59	58	57	56	55	54	53								52	51	50	49	48	47	46	44	43	42	41	40	39	38	37	36	35	34	33								73			32	31	30	29	28	27	25	24	23	22	21	20	19	18	17											16	15	14	13	12	11	9	8	7	6	5	4	3	2	1	AVAILABLE	NOT APPLICABLE	34566-3103	G	0	B	ST GRAY							65		62		59		57		55		53											49	48		46		42		39		37		35		33								73						29		26		23		21				18																	9	8	7			4	3			AVAILABLE	NOT APPLICABLE	34566-3203	G	0	B	ST GRAY							67				60	59	58	57	56	55	53										50	49	48		46				39	38	37		35	34	33								73						29			23	22	21			18																	7	6	5	4	3			AVAILABLE	NOT APPLICABLE	34566-3303	G	0	B	ST GRAY											59	58	57	56	55	53										50	49	48		46				39	38	37		35	34	33								73						29			23	22	21			18																	7	6	5	4	3			AVAILABLE	NOT APPLICABLE	34566-3403	SEE 34566-3003																AVAILABLE	NOT APPLICABLE	34566-3503	G	0	A	BLACK	72	71	70	69	68	67	66	64	63	62	60	59													52		49	48		46		44	43	42	40	39					35	34	33								73						32		29		27		24	23			19	18	17																			9	8	7	6	5	4	3	2	1
							52	51	49	48	47	46	44	43	42	41	39			35	34	33								73			32	31	29	27	25	23			19	18	17											16	15	14	13	12	11	9	8	7	6	5	4	3	2	1	AVAILABLE	NOT APPLICABLE	34566-3003	G	0	A	BLACK	72	71	70	69	68	67	66	64	63	62	60	59	58	57	56	55	54	53								52	51	50	49	48	47	46	44	43	42	41	40	39	38	37	36	35	34	33								73			32	31	30	29	28	27	25	24	23	22	21	20	19	18	17											16	15	14	13	12	11	9	8	7	6	5	4	3	2	1	AVAILABLE	NOT APPLICABLE	34566-3103	G	0	B	ST GRAY							65		62		59		57		55		53											49	48		46		42		39		37		35		33								73						29		26		23		21				18																	9	8	7			4	3			AVAILABLE	NOT APPLICABLE	34566-3203	G	0	B	ST GRAY							67				60	59	58	57	56	55	53										50	49	48		46				39	38	37		35	34	33								73						29			23	22	21			18																	7	6	5	4	3			AVAILABLE	NOT APPLICABLE	34566-3303	G	0	B	ST GRAY											59	58	57	56	55	53										50	49	48		46				39	38	37		35	34	33								73						29			23	22	21			18																	7	6	5	4	3			AVAILABLE	NOT APPLICABLE	34566-3403	SEE 34566-3003																AVAILABLE	NOT APPLICABLE	34566-3503	G	0	A	BLACK	72	71	70	69	68	67	66	64	63	62	60	59													52		49	48		46		44	43	42	40	39					35	34	33								73						32		29		27		24	23			19	18	17																			9	8	7	6	5	4	3	2	1																								
							73			32	31	29	27	25	23			19	18	17											16	15	14	13	12	11	9	8	7	6	5	4	3	2	1	AVAILABLE	NOT APPLICABLE	34566-3003	G	0	A	BLACK	72	71	70	69	68	67	66	64	63	62	60	59	58	57	56	55	54	53								52	51	50	49	48	47	46	44	43	42	41	40	39	38	37	36	35	34	33								73			32	31	30	29	28	27	25	24	23	22	21	20	19	18	17											16	15	14	13	12	11	9	8	7	6	5	4	3	2	1	AVAILABLE	NOT APPLICABLE	34566-3103	G	0	B	ST GRAY							65		62		59		57		55		53											49	48		46		42		39		37		35		33								73						29		26		23		21				18																	9	8	7			4	3			AVAILABLE	NOT APPLICABLE	34566-3203	G	0	B	ST GRAY							67				60	59	58	57	56	55	53										50	49	48		46				39	38	37		35	34	33								73						29			23	22	21			18																	7	6	5	4	3			AVAILABLE	NOT APPLICABLE	34566-3303	G	0	B	ST GRAY											59	58	57	56	55	53										50	49	48		46				39	38	37		35	34	33								73						29			23	22	21			18																	7	6	5	4	3			AVAILABLE	NOT APPLICABLE	34566-3403	SEE 34566-3003																AVAILABLE	NOT APPLICABLE	34566-3503	G	0	A	BLACK	72	71	70	69	68	67	66	64	63	62	60	59													52		49	48		46		44	43	42	40	39					35	34	33								73						32		29		27		24	23			19	18	17																			9	8	7	6	5	4	3	2	1																																															
										16	15	14	13	12	11	9	8	7	6	5	4	3	2	1																																																																																																																																																																																																																																																																																																																																																																																																																																																																																																																																																																																													
AVAILABLE	NOT APPLICABLE	34566-3003	G	0	A	BLACK	72	71	70	69	68	67	66	64	63	62	60	59	58	57	56	55	54	53								52	51	50	49	48	47	46	44	43	42	41	40	39	38	37	36	35	34	33								73			32	31	30	29	28	27	25	24	23	22	21	20	19	18	17											16	15	14	13	12	11	9	8	7	6	5	4	3	2	1	AVAILABLE	NOT APPLICABLE	34566-3103	G	0	B	ST GRAY							65		62		59		57		55		53											49	48		46		42		39		37		35		33								73						29		26		23		21				18																	9	8	7			4	3			AVAILABLE	NOT APPLICABLE	34566-3203	G	0	B	ST GRAY							67				60	59	58	57	56	55	53										50	49	48		46				39	38	37		35	34	33								73						29			23	22	21			18																	7	6	5	4	3			AVAILABLE	NOT APPLICABLE	34566-3303	G	0	B	ST GRAY											59	58	57	56	55	53										50	49	48		46				39	38	37		35	34	33								73						29			23	22	21			18																	7	6	5	4	3			AVAILABLE	NOT APPLICABLE	34566-3403	SEE 34566-3003																AVAILABLE	NOT APPLICABLE	34566-3503	G	0	A	BLACK	72	71	70	69	68	67	66	64	63	62	60	59													52		49	48		46		44	43	42	40	39					35	34	33								73						32		29		27		24	23			19	18	17																			9	8	7	6	5	4	3	2	1																																																																																													
							52	51	50	49	48	47	46	44	43	42	41	40	39	38	37	36	35	34	33								73			32	31	30	29	28	27	25	24	23	22	21	20	19	18	17											16	15	14	13	12	11	9	8	7	6	5	4	3	2	1	AVAILABLE	NOT APPLICABLE	34566-3103	G	0	B	ST GRAY							65		62		59		57		55		53											49	48		46		42		39		37		35		33								73						29		26		23		21				18																	9	8	7			4	3			AVAILABLE	NOT APPLICABLE	34566-3203	G	0	B	ST GRAY							67				60	59	58	57	56	55	53										50	49	48		46				39	38	37		35	34	33								73						29			23	22	21			18																	7	6	5	4	3			AVAILABLE	NOT APPLICABLE	34566-3303	G	0	B	ST GRAY											59	58	57	56	55	53										50	49	48		46				39	38	37		35	34	33								73						29			23	22	21			18																	7	6	5	4	3			AVAILABLE	NOT APPLICABLE	34566-3403	SEE 34566-3003																AVAILABLE	NOT APPLICABLE	34566-3503	G	0	A	BLACK	72	71	70	69	68	67	66	64	63	62	60	59													52		49	48		46		44	43	42	40	39					35	34	33								73						32		29		27		24	23			19	18	17																			9	8	7	6	5	4	3	2	1																																																																																																																						
							73			32	31	30	29	28	27	25	24	23	22	21	20	19	18	17											16	15	14	13	12	11	9	8	7	6	5	4	3	2	1	AVAILABLE	NOT APPLICABLE	34566-3103	G	0	B	ST GRAY							65		62		59		57		55		53											49	48		46		42		39		37		35		33								73						29		26		23		21				18																	9	8	7			4	3			AVAILABLE	NOT APPLICABLE	34566-3203	G	0	B	ST GRAY							67				60	59	58	57	56	55	53										50	49	48		46				39	38	37		35	34	33								73						29			23	22	21			18																	7	6	5	4	3			AVAILABLE	NOT APPLICABLE	34566-3303	G	0	B	ST GRAY											59	58	57	56	55	53										50	49	48		46				39	38	37		35	34	33								73						29			23	22	21			18																	7	6	5	4	3			AVAILABLE	NOT APPLICABLE	34566-3403	SEE 34566-3003																AVAILABLE	NOT APPLICABLE	34566-3503	G	0	A	BLACK	72	71	70	69	68	67	66	64	63	62	60	59													52		49	48		46		44	43	42	40	39					35	34	33								73						32		29		27		24	23			19	18	17																			9	8	7	6	5	4	3	2	1																																																																																																																																																
										16	15	14	13	12	11	9	8	7	6	5	4	3	2	1																																																																																																																																																																																																																																																																																																																																																																																																																																																																																																																																																																																													
AVAILABLE	NOT APPLICABLE	34566-3103	G	0	B	ST GRAY							65		62		59		57		55		53											49	48		46		42		39		37		35		33								73						29		26		23		21				18																	9	8	7			4	3			AVAILABLE	NOT APPLICABLE	34566-3203	G	0	B	ST GRAY							67				60	59	58	57	56	55	53										50	49	48		46				39	38	37		35	34	33								73						29			23	22	21			18																	7	6	5	4	3			AVAILABLE	NOT APPLICABLE	34566-3303	G	0	B	ST GRAY											59	58	57	56	55	53										50	49	48		46				39	38	37		35	34	33								73						29			23	22	21			18																	7	6	5	4	3			AVAILABLE	NOT APPLICABLE	34566-3403	SEE 34566-3003																AVAILABLE	NOT APPLICABLE	34566-3503	G	0	A	BLACK	72	71	70	69	68	67	66	64	63	62	60	59													52		49	48		46		44	43	42	40	39					35	34	33								73						32		29		27		24	23			19	18	17																			9	8	7	6	5	4	3	2	1																																																																																																																																																																																																		
										49	48		46		42		39		37		35		33								73						29		26		23		21				18																	9	8	7			4	3			AVAILABLE	NOT APPLICABLE	34566-3203	G	0	B	ST GRAY							67				60	59	58	57	56	55	53										50	49	48		46				39	38	37		35	34	33								73						29			23	22	21			18																	7	6	5	4	3			AVAILABLE	NOT APPLICABLE	34566-3303	G	0	B	ST GRAY											59	58	57	56	55	53										50	49	48		46				39	38	37		35	34	33								73						29			23	22	21			18																	7	6	5	4	3			AVAILABLE	NOT APPLICABLE	34566-3403	SEE 34566-3003																AVAILABLE	NOT APPLICABLE	34566-3503	G	0	A	BLACK	72	71	70	69	68	67	66	64	63	62	60	59													52		49	48		46		44	43	42	40	39					35	34	33								73						32		29		27		24	23			19	18	17																			9	8	7	6	5	4	3	2	1																																																																																																																																																																																																																										
							73						29		26		23		21				18																	9	8	7			4	3			AVAILABLE	NOT APPLICABLE	34566-3203	G	0	B	ST GRAY							67				60	59	58	57	56	55	53										50	49	48		46				39	38	37		35	34	33								73						29			23	22	21			18																	7	6	5	4	3			AVAILABLE	NOT APPLICABLE	34566-3303	G	0	B	ST GRAY											59	58	57	56	55	53										50	49	48		46				39	38	37		35	34	33								73						29			23	22	21			18																	7	6	5	4	3			AVAILABLE	NOT APPLICABLE	34566-3403	SEE 34566-3003																AVAILABLE	NOT APPLICABLE	34566-3503	G	0	A	BLACK	72	71	70	69	68	67	66	64	63	62	60	59													52		49	48		46		44	43	42	40	39					35	34	33								73						32		29		27		24	23			19	18	17																			9	8	7	6	5	4	3	2	1																																																																																																																																																																																																																																																		
																9	8	7			4	3																																																																																																																																																																																																																																																																																																																																																																																																																																																																																																																																																																																															
AVAILABLE	NOT APPLICABLE	34566-3203	G	0	B	ST GRAY							67				60	59	58	57	56	55	53										50	49	48		46				39	38	37		35	34	33								73						29			23	22	21			18																	7	6	5	4	3			AVAILABLE	NOT APPLICABLE	34566-3303	G	0	B	ST GRAY											59	58	57	56	55	53										50	49	48		46				39	38	37		35	34	33								73						29			23	22	21			18																	7	6	5	4	3			AVAILABLE	NOT APPLICABLE	34566-3403	SEE 34566-3003																AVAILABLE	NOT APPLICABLE	34566-3503	G	0	A	BLACK	72	71	70	69	68	67	66	64	63	62	60	59													52		49	48		46		44	43	42	40	39					35	34	33								73						32		29		27		24	23			19	18	17																			9	8	7	6	5	4	3	2	1																																																																																																																																																																																																																																																																																																			
									50	49	48		46				39	38	37		35	34	33								73						29			23	22	21			18																	7	6	5	4	3			AVAILABLE	NOT APPLICABLE	34566-3303	G	0	B	ST GRAY											59	58	57	56	55	53										50	49	48		46				39	38	37		35	34	33								73						29			23	22	21			18																	7	6	5	4	3			AVAILABLE	NOT APPLICABLE	34566-3403	SEE 34566-3003																AVAILABLE	NOT APPLICABLE	34566-3503	G	0	A	BLACK	72	71	70	69	68	67	66	64	63	62	60	59													52		49	48		46		44	43	42	40	39					35	34	33								73						32		29		27		24	23			19	18	17																			9	8	7	6	5	4	3	2	1																																																																																																																																																																																																																																																																																																																											
							73						29			23	22	21			18																	7	6	5	4	3			AVAILABLE	NOT APPLICABLE	34566-3303	G	0	B	ST GRAY											59	58	57	56	55	53										50	49	48		46				39	38	37		35	34	33								73						29			23	22	21			18																	7	6	5	4	3			AVAILABLE	NOT APPLICABLE	34566-3403	SEE 34566-3003																AVAILABLE	NOT APPLICABLE	34566-3503	G	0	A	BLACK	72	71	70	69	68	67	66	64	63	62	60	59													52		49	48		46		44	43	42	40	39					35	34	33								73						32		29		27		24	23			19	18	17																			9	8	7	6	5	4	3	2	1																																																																																																																																																																																																																																																																																																																																																			
																7	6	5	4	3																																																																																																																																																																																																																																																																																																																																																																																																																																																																																																																																																																																																	
AVAILABLE	NOT APPLICABLE	34566-3303	G	0	B	ST GRAY											59	58	57	56	55	53										50	49	48		46				39	38	37		35	34	33								73						29			23	22	21			18																	7	6	5	4	3			AVAILABLE	NOT APPLICABLE	34566-3403	SEE 34566-3003																AVAILABLE	NOT APPLICABLE	34566-3503	G	0	A	BLACK	72	71	70	69	68	67	66	64	63	62	60	59													52		49	48		46		44	43	42	40	39					35	34	33								73						32		29		27		24	23			19	18	17																			9	8	7	6	5	4	3	2	1																																																																																																																																																																																																																																																																																																																																																																																																
									50	49	48		46				39	38	37		35	34	33								73						29			23	22	21			18																	7	6	5	4	3			AVAILABLE	NOT APPLICABLE	34566-3403	SEE 34566-3003																AVAILABLE	NOT APPLICABLE	34566-3503	G	0	A	BLACK	72	71	70	69	68	67	66	64	63	62	60	59													52		49	48		46		44	43	42	40	39					35	34	33								73						32		29		27		24	23			19	18	17																			9	8	7	6	5	4	3	2	1																																																																																																																																																																																																																																																																																																																																																																																																																							
							73						29			23	22	21			18																	7	6	5	4	3			AVAILABLE	NOT APPLICABLE	34566-3403	SEE 34566-3003																AVAILABLE	NOT APPLICABLE	34566-3503	G	0	A	BLACK	72	71	70	69	68	67	66	64	63	62	60	59													52		49	48		46		44	43	42	40	39					35	34	33								73						32		29		27		24	23			19	18	17																			9	8	7	6	5	4	3	2	1																																																																																																																																																																																																																																																																																																																																																																																																																																															
																7	6	5	4	3																																																																																																																																																																																																																																																																																																																																																																																																																																																																																																																																																																																																	
AVAILABLE	NOT APPLICABLE	34566-3403	SEE 34566-3003																																																																																																																																																																																																																																																																																																																																																																																																																																																																																																																																																																																																																		
AVAILABLE	NOT APPLICABLE	34566-3503	G	0	A	BLACK	72	71	70	69	68	67	66	64	63	62	60	59													52		49	48		46		44	43	42	40	39					35	34	33								73						32		29		27		24	23			19	18	17																			9	8	7	6	5	4	3	2	1																																																																																																																																																																																																																																																																																																																																																																																																																																																																																																															
							52		49	48		46		44	43	42	40	39					35	34	33								73						32		29		27		24	23			19	18	17																			9	8	7	6	5	4	3	2	1																																																																																																																																																																																																																																																																																																																																																																																																																																																																																																																																							
							73						32		29		27		24	23			19	18	17																			9	8	7	6	5	4	3	2	1																																																																																																																																																																																																																																																																																																																																																																																																																																																																																																																																																																	
																		9	8	7	6	5	4	3	2	1																																																																																																																																																																																																																																																																																																																																																																																																																																																																																																																																																																																											

SEE NEXT PAGE FOR ADDITIONAL NUMBERS

<b>ENTER DESCRIPTION</b> EC NO: UAU2010-1551 DRAWN BY: 2010/03/15 CHKDGR: FFH APPR: VKOSHY 2010/03/18 2008/05/09 2010/03/18	QUALITY SYMBOLS	GENERAL TOLERANCES (UNLESS SPECIFIED)	DIMENSION STYLE	SCALE	DESIGN UNITS	THIRD ANGLE PROJECTION	
	▽=0 ▽=0	mm INCH 4 PLACES ±---+--- 3 PLACES ±---+--- 2 PLACES ±---+--- 1 PLACE ±---+--- ANGULAR ±---°	MM ONLY	1:1	METRIC	DRAWN BY: SRAJENDRANAT CHECKED BY: TSKIVER APPROVED BY: VKOSHY DATE: 2008/05/09 DATE: 2010/03/18	
	DRAFT WHERE APPLICABLE MUST REMAIN WITHIN DIMENSIONS			SEE BOM TABLE		TITLE: MX123 73/80 CKT HRNS CONN ASSY MOLEX INCORPORATED DOCUMENT NO: SD-34566-001 SHEET NO: 6 OF 36	
	THIS DRAWING CONTAINS INFORMATION THAT IS PROPRIETARY TO MOLEX INCORPORATED AND SHOULD NOT BE USED WITHOUT WRITTEN PERMISSION						

19 18 17 16 15 14 13 12 11 10 9 8 7 6 5 4 3 2 1







STATUS	GM PART #	MATERIAL #	PART/MATERIAL REVISION	WIRE DRESS OPTION	KEY OPTION	COLOR (TPA)	NUMBERS INDICATE CAVITIES OPEN FOR CIRCUITS																																																																				
AVAILABLE	NOT APPLICABLE	34566-5203	G	0	A	BLACK	<table border="1"> <tr><td>72</td><td>71</td><td>69</td><td>68</td><td>67</td><td>66</td><td>64</td><td>63</td><td>62</td><td>59</td><td>58</td><td>57</td><td>56</td><td>54</td><td>53</td></tr> <tr><td>52</td><td>51</td><td>50</td><td>49</td><td>48</td><td>47</td><td>46</td><td>44</td><td>43</td><td>42</td><td>39</td><td>38</td><td>37</td><td>36</td><td>35</td><td>34</td><td>33</td></tr> <tr><td colspan="2">73</td><td>32</td><td>31</td><td>30</td><td>29</td><td>27</td><td colspan="2"></td><td>24</td><td>23</td><td>22</td><td>21</td><td>20</td><td>19</td><td>17</td><td></td></tr> <tr><td colspan="2"></td><td>15</td><td>14</td><td>13</td><td>12</td><td>11</td><td>9</td><td>8</td><td>7</td><td>6</td><td>5</td><td>4</td><td>3</td><td>2</td><td>1</td><td></td></tr> </table>	72	71	69	68	67	66	64	63	62	59	58	57	56	54	53	52	51	50	49	48	47	46	44	43	42	39	38	37	36	35	34	33	73		32	31	30	29	27			24	23	22	21	20	19	17				15	14	13	12	11	9	8	7	6	5	4	3	2	1			
72	71	69	68	67	66	64	63	62	59	58	57	56	54	53																																																													
52	51	50	49	48	47	46	44	43	42	39	38	37	36	35	34	33																																																											
73		32	31	30	29	27			24	23	22	21	20	19	17																																																												
		15	14	13	12	11	9	8	7	6	5	4	3	2	1																																																												
AVAILABLE	NOT APPLICABLE	34566-5303	G	0	B	ST GRY	<table border="1"> <tr><td colspan="2"></td><td colspan="2"></td><td colspan="2"></td><td>65</td><td>64</td><td colspan="2"></td><td>59</td><td>57</td><td>55</td><td>53</td><td colspan="3"></td></tr> <tr><td colspan="2"></td><td>50</td><td>49</td><td>48</td><td>46</td><td colspan="2"></td><td colspan="2"></td><td>39</td><td>37</td><td>35</td><td>33</td><td colspan="3"></td></tr> <tr><td colspan="2">73</td><td colspan="2">32</td><td colspan="2">29</td><td colspan="2"></td><td colspan="2"></td><td>23</td><td>21</td><td colspan="2"></td><td colspan="3"></td></tr> <tr><td colspan="2"></td><td colspan="2">15</td><td colspan="2"></td><td colspan="2"></td><td colspan="2"></td><td>7</td><td>6</td><td>5</td><td>4</td><td>3</td><td colspan="2"></td></tr> </table>							65	64			59	57	55	53						50	49	48	46					39	37	35	33				73		32		29						23	21								15								7	6	5	4	3		
						65	64			59	57	55	53																																																														
		50	49	48	46					39	37	35	33																																																														
73		32		29						23	21																																																																
		15								7	6	5	4	3																																																													
AVAILABLE	NOT APPLICABLE	34566-5403	G	0	B	ST GRY	<table border="1"> <tr><td colspan="2"></td><td colspan="2"></td><td colspan="2"></td><td>65</td><td colspan="2"></td><td>59</td><td>58</td><td>57</td><td>56</td><td>55</td><td>53</td><td colspan="2"></td></tr> <tr><td colspan="2"></td><td>50</td><td>49</td><td>48</td><td>46</td><td>45</td><td colspan="2"></td><td>39</td><td>38</td><td>37</td><td>35</td><td>34</td><td>33</td><td colspan="2"></td></tr> <tr><td colspan="2">73</td><td colspan="2">32</td><td colspan="2">29</td><td colspan="2"></td><td colspan="2"></td><td>23</td><td>22</td><td>21</td><td colspan="2">18</td><td colspan="2"></td></tr> <tr><td colspan="2"></td><td>16</td><td>15</td><td>14</td><td colspan="2"></td><td colspan="2"></td><td>7</td><td>6</td><td>5</td><td>4</td><td>3</td><td colspan="2"></td></tr> </table>							65			59	58	57	56	55	53					50	49	48	46	45			39	38	37	35	34	33			73		32		29						23	22	21	18						16	15	14					7	6	5	4	3			
						65			59	58	57	56	55	53																																																													
		50	49	48	46	45			39	38	37	35	34	33																																																													
73		32		29						23	22	21	18																																																														
		16	15	14					7	6	5	4	3																																																														
AVAILABLE	NOT APPLICABLE	34566-5503	G	0	A	BLACK	<table border="1"> <tr><td>72</td><td>71</td><td>69</td><td>68</td><td>67</td><td>66</td><td>64</td><td>63</td><td>62</td><td>60</td><td>59</td><td colspan="2"></td><td colspan="2"></td><td colspan="2"></td></tr> <tr><td>52</td><td colspan="2"></td><td>49</td><td>48</td><td>46</td><td>44</td><td>43</td><td>42</td><td>40</td><td>39</td><td colspan="2"></td><td>35</td><td>33</td><td colspan="2"></td></tr> <tr><td colspan="2">73</td><td colspan="2">32</td><td colspan="2">29</td><td colspan="2">27</td><td>26</td><td>24</td><td>23</td><td colspan="2"></td><td colspan="2"></td><td colspan="2"></td></tr> <tr><td colspan="2"></td><td colspan="2">14</td><td>13</td><td>12</td><td>11</td><td>10</td><td>9</td><td>8</td><td>7</td><td>6</td><td>5</td><td>4</td><td>3</td><td>2</td><td>1</td></tr> </table>	72	71	69	68	67	66	64	63	62	60	59							52			49	48	46	44	43	42	40	39			35	33			73		32		29		27		26	24	23									14		13	12	11	10	9	8	7	6	5	4	3	2	1
72	71	69	68	67	66	64	63	62	60	59																																																																	
52			49	48	46	44	43	42	40	39			35	33																																																													
73		32		29		27		26	24	23																																																																	
		14		13	12	11	10	9	8	7	6	5	4	3	2	1																																																											
AVAILABLE	NOT APPLICABLE	34566-5603					SEE 34566-2503																																																																				
AVAILABLE	NOT APPLICABLE	34566-5703	G	0	B	ST GRY	<table border="1"> <tr><td colspan="2"></td><td colspan="2"></td><td>68</td><td colspan="2"></td><td colspan="2"></td><td>59</td><td>57</td><td>55</td><td>53</td><td colspan="3"></td></tr> <tr><td colspan="2"></td><td>49</td><td>48</td><td>46</td><td colspan="2"></td><td colspan="2"></td><td>39</td><td>37</td><td>35</td><td>33</td><td colspan="3"></td></tr> <tr><td colspan="2">73</td><td colspan="2"></td><td colspan="2">29</td><td colspan="2"></td><td colspan="2"></td><td>23</td><td>21</td><td colspan="2">18</td><td colspan="2">17</td><td></td></tr> <tr><td colspan="2"></td><td colspan="2"></td><td colspan="2"></td><td>12</td><td>11</td><td>10</td><td>7</td><td colspan="2"></td><td colspan="2"></td><td colspan="2"></td><td></td></tr> </table>					68					59	57	55	53						49	48	46					39	37	35	33				73				29						23	21	18		17									12	11	10	7									
				68					59	57	55	53																																																															
		49	48	46					39	37	35	33																																																															
73				29						23	21	18		17																																																													
						12	11	10	7																																																																		
AVAILABLE	NOT APPLICABLE	34566-5803	G	0	B	ST GRY	<table border="1"> <tr><td colspan="2"></td><td colspan="2"></td><td colspan="2"></td><td>65</td><td colspan="2"></td><td>59</td><td>57</td><td>55</td><td>53</td><td colspan="3"></td></tr> <tr><td colspan="2"></td><td>49</td><td>48</td><td>47</td><td colspan="2"></td><td colspan="2"></td><td>39</td><td>37</td><td>35</td><td>33</td><td colspan="3"></td></tr> <tr><td colspan="2">73</td><td colspan="2"></td><td colspan="2">29</td><td colspan="2"></td><td colspan="2"></td><td>23</td><td>21</td><td colspan="2">17</td><td colspan="3"></td></tr> <tr><td colspan="2"></td><td colspan="2"></td><td colspan="2">12</td><td colspan="2"></td><td colspan="2"></td><td>7</td><td colspan="2"></td><td colspan="2"></td><td colspan="2"></td></tr> </table>							65			59	57	55	53						49	48	47					39	37	35	33				73				29						23	21	17									12						7								
						65			59	57	55	53																																																															
		49	48	47					39	37	35	33																																																															
73				29						23	21	17																																																															
				12						7																																																																	
AVAILABLE	NOT APPLICABLE	34566-5903	G	0	A	BLACK	<table border="1"> <tr><td>72</td><td>71</td><td>69</td><td>68</td><td>67</td><td>66</td><td>64</td><td>63</td><td>62</td><td>59</td><td colspan="2"></td><td colspan="2"></td><td colspan="2"></td></tr> <tr><td colspan="2"></td><td colspan="2">48</td><td colspan="2"></td><td>44</td><td>43</td><td>42</td><td>39</td><td colspan="2"></td><td>35</td><td>33</td><td colspan="2"></td></tr> <tr><td colspan="2">73</td><td colspan="2">32</td><td colspan="2">29</td><td colspan="2">27</td><td>26</td><td>24</td><td>23</td><td colspan="2"></td><td colspan="2">17</td><td colspan="2"></td></tr> <tr><td colspan="2"></td><td colspan="2"></td><td>13</td><td>12</td><td>11</td><td>9</td><td>8</td><td colspan="2"></td><td>5</td><td>4</td><td>3</td><td>2</td><td>1</td><td></td></tr> </table>	72	71	69	68	67	66	64	63	62	59									48				44	43	42	39			35	33			73		32		29		27		26	24	23			17								13	12	11	9	8			5	4	3	2	1			
72	71	69	68	67	66	64	63	62	59																																																																		
		48				44	43	42	39			35	33																																																														
73		32		29		27		26	24	23			17																																																														
				13	12	11	9	8			5	4	3	2	1																																																												
SEE NEXT PAGE FOR ADDITIONAL NUMBERS																																																																											

<b>ENTER DESCRIPTION</b> EC NO: UAU2010-1551 DRAWN BY: DRWNAH01 CHECKED BY: CHKDRFF1 APPROVED BY: APPR.VKOSHY DATE: 2010/03/15 DATE: 2008/05/09 DATE: 2010/03/18 REV: F40	QUALITY SYMBOLS ▽=0 ▽=0	GENERAL TOLERANCES (UNLESS SPECIFIED) <table border="1"> <tr><th>mm</th><th>INCH</th></tr> <tr><td>4 PLACES ±</td><td>±</td></tr> <tr><td>3 PLACES ±</td><td>±</td></tr> <tr><td>2 PLACES ±</td><td>±</td></tr> <tr><td>1 PLACE ±</td><td>±</td></tr> </table> ANGULAR ±	mm	INCH	4 PLACES ±	±	3 PLACES ±	±	2 PLACES ±	±	1 PLACE ±	±	DIMENSION STYLE <b>MM ONLY</b>	SCALE <b>1:1</b>	DESIGN UNITS <b>METRIC</b>	THIRD ANGLE PROJECTION
	mm	INCH														
	4 PLACES ±	±														
	3 PLACES ±	±														
2 PLACES ±	±															
1 PLACE ±	±															
DRAWN BY: SRAJENDRANAT CHECKED BY: TSKIVER APPROVED BY: VKOSHY DATE: 2008/05/09 DATE: 2008/05/09 DATE: 2010/03/18	TITLE <b>MX123 73/80 CKT HRNS CONN ASSY</b>	MATERIAL NO. <b>SEE BOM TABLE</b>	DOCUMENT NO. <b>SD-34566-001</b>	SHEET NO. <b>9 OF 36</b>												
<b>MOLEX INCORPORATED</b>																
THIS DRAWING CONTAINS INFORMATION THAT IS PROPRIETARY TO MOLEX INCORPORATED AND SHOULD NOT BE USED WITHOUT WRITTEN PERMISSION																





STATUS	GM PART #	MATERIAL #	PART/MATERIAL REVISION	WIRE DRESS OPTION	KEY OPTION	COLOR (TPA)	NUMBERS INDICATE CAVITIES OPEN FOR CIRCUITS																																																																																											
AVAILABLE	NOT APPLICABLE	34566-7603	G	0	B	ST GRAY	<table border="1"> <tr><td></td><td></td><td>69</td><td>68</td><td>66</td><td></td><td></td><td></td><td></td><td></td><td></td><td></td><td></td><td></td><td>59</td><td>57</td><td>55</td><td>53</td></tr> <tr><td></td><td></td><td>49</td><td>48</td><td>46</td><td></td><td>44</td><td></td><td></td><td></td><td></td><td></td><td></td><td></td><td>39</td><td>37</td><td>35</td><td>33</td></tr> <tr><td colspan="2">73</td><td></td><td></td><td></td><td></td><td>29</td><td>28</td><td></td><td></td><td></td><td></td><td></td><td></td><td>23</td><td>21</td><td></td><td>18</td><td>17</td></tr> <tr><td></td><td></td><td></td><td></td><td></td><td></td><td>12</td><td>11</td><td>10</td><td></td><td></td><td></td><td></td><td></td><td>7</td><td></td><td></td><td></td><td></td></tr> </table>																		69	68	66										59	57	55	53			49	48	46		44								39	37	35	33	73						29	28							23	21		18	17							12	11	10						7						
		69	68	66										59	57	55	53																																																																																	
		49	48	46		44								39	37	35	33																																																																																	
73						29	28							23	21		18	17																																																																																
						12	11	10						7																																																																																				
AVAILABLE	NOT APPLICABLE	34566-7703	G	0	A	BLACK	<table border="1"> <tr><td>72</td><td>71</td><td>70</td><td>69</td><td>68</td><td>67</td><td>66</td><td></td><td>64</td><td>63</td><td>62</td><td></td><td>60</td><td>59</td><td></td><td></td><td>55</td><td>54</td><td>53</td></tr> <tr><td>52</td><td></td><td>49</td><td>48</td><td></td><td></td><td></td><td></td><td>44</td><td>43</td><td>42</td><td></td><td>40</td><td>39</td><td></td><td></td><td>35</td><td>34</td><td>33</td></tr> <tr><td colspan="2">73</td><td></td><td>32</td><td></td><td></td><td>29</td><td>27</td><td></td><td></td><td></td><td></td><td>24</td><td>23</td><td></td><td></td><td>19</td><td>18</td><td>17</td></tr> <tr><td></td><td></td><td>16</td><td></td><td></td><td>13</td><td>12</td><td>11</td><td></td><td></td><td>9</td><td>8</td><td>7</td><td>6</td><td>5</td><td>4</td><td>3</td><td>2</td><td>1</td></tr> </table>																72	71	70	69	68	67	66		64	63	62		60	59			55	54	53	52		49	48					44	43	42		40	39			35	34	33	73			32			29	27					24	23			19	18	17			16			13	12	11			9	8	7	6	5	4	3	2	1
72	71	70	69	68	67	66		64	63	62		60	59			55	54	53																																																																																
52		49	48					44	43	42		40	39			35	34	33																																																																																
73			32			29	27					24	23			19	18	17																																																																																
		16			13	12	11			9	8	7	6	5	4	3	2	1																																																																																
AVAILABLE	NOT APPLICABLE	34566-7803	G	0	A	BLACK	<table border="1"> <tr><td>72</td><td>71</td><td>70</td><td></td><td>68</td><td>66</td><td></td><td>64</td><td>63</td><td>62</td><td>61</td><td>60</td><td>59</td><td></td><td></td><td></td><td>55</td><td>54</td><td>53</td></tr> <tr><td>52</td><td></td><td>49</td><td>48</td><td></td><td>46</td><td></td><td>44</td><td>43</td><td>42</td><td></td><td>40</td><td>39</td><td></td><td></td><td></td><td>35</td><td>34</td><td>33</td></tr> <tr><td colspan="2">73</td><td></td><td>32</td><td></td><td></td><td>29</td><td>28</td><td>27</td><td></td><td></td><td>24</td><td>23</td><td></td><td></td><td></td><td>19</td><td>18</td><td>17</td></tr> <tr><td></td><td></td><td>16</td><td></td><td>14</td><td>13</td><td>12</td><td>11</td><td></td><td></td><td>9</td><td>8</td><td>7</td><td>6</td><td></td><td></td><td>3</td><td>2</td><td>1</td></tr> </table>																72	71	70		68	66		64	63	62	61	60	59				55	54	53	52		49	48		46		44	43	42		40	39				35	34	33	73			32			29	28	27			24	23				19	18	17			16		14	13	12	11			9	8	7	6			3	2	1
72	71	70		68	66		64	63	62	61	60	59				55	54	53																																																																																
52		49	48		46		44	43	42		40	39				35	34	33																																																																																
73			32			29	28	27			24	23				19	18	17																																																																																
		16		14	13	12	11			9	8	7	6			3	2	1																																																																																
AVAILABLE	NOT APPLICABLE	34566-7903	G	0	B	ST GRAY	<table border="1"> <tr><td></td><td></td><td></td><td></td><td></td><td></td><td></td><td></td><td>64</td><td></td><td>61</td><td>59</td><td>57</td><td>55</td><td>53</td><td></td><td></td><td></td><td></td></tr> <tr><td></td><td></td><td></td><td></td><td></td><td></td><td></td><td></td><td></td><td></td><td>42</td><td></td><td>39</td><td></td><td>35</td><td>34</td><td>33</td><td></td><td></td></tr> <tr><td colspan="2">73</td><td></td><td></td><td></td><td></td><td></td><td></td><td></td><td></td><td></td><td></td><td>23</td><td></td><td>20</td><td>19</td><td>18</td><td>17</td><td></td></tr> <tr><td></td><td></td><td></td><td></td><td></td><td>15</td><td></td><td></td><td></td><td></td><td></td><td></td><td></td><td></td><td>4</td><td>3</td><td>2</td><td>1</td><td></td></tr> </table>																								64		61	59	57	55	53															42		39		35	34	33			73												23		20	19	18	17							15									4	3	2	1	
								64		61	59	57	55	53																																																																																				
										42		39		35	34	33																																																																																		
73												23		20	19	18	17																																																																																	
					15									4	3	2	1																																																																																	
AVAILABLE	NOT APPLICABLE	34566-8003	G	0	A	BLACK	<table border="1"> <tr><td></td><td></td><td>69</td><td>68</td><td></td><td></td><td>65</td><td>64</td><td>63</td><td></td><td>61</td><td>60</td><td>59</td><td>58</td><td>56</td><td></td><td></td><td></td><td></td></tr> <tr><td>52</td><td>50</td><td>49</td><td>48</td><td>47</td><td></td><td></td><td></td><td></td><td></td><td>41</td><td></td><td></td><td>38</td><td>37</td><td>36</td><td></td><td>34</td><td>33</td></tr> <tr><td colspan="2">73</td><td></td><td>32</td><td>31</td><td>30</td><td>29</td><td>28</td><td>27</td><td></td><td></td><td>24</td><td>23</td><td></td><td></td><td>20</td><td>19</td><td>18</td><td>17</td></tr> <tr><td></td><td></td><td>16</td><td></td><td></td><td></td><td>13</td><td>12</td><td>11</td><td>10</td><td>9</td><td></td><td></td><td></td><td></td><td></td><td></td><td></td><td>1</td></tr> </table>																		69	68			65	64	63		61	60	59	58	56					52	50	49	48	47						41			38	37	36		34	33	73			32	31	30	29	28	27			24	23			20	19	18	17			16				13	12	11	10	9								1
		69	68			65	64	63		61	60	59	58	56																																																																																				
52	50	49	48	47						41			38	37	36		34	33																																																																																
73			32	31	30	29	28	27			24	23			20	19	18	17																																																																																
		16				13	12	11	10	9								1																																																																																
AVAILABLE	NOT APPLICABLE	34566-8103	G	0	H	ST GRAY	<table border="1"> <tr><td></td><td>78</td><td></td><td></td><td></td><td></td><td></td><td>72</td><td>71</td><td>70</td><td>69</td><td>68</td><td></td><td>66</td><td>65</td><td>64</td><td>63</td><td>61</td><td></td></tr> <tr><td>60</td><td>59</td><td>58</td><td>57</td><td>56</td><td></td><td></td><td>53</td><td>52</td><td>50</td><td></td><td></td><td></td><td></td><td></td><td>44</td><td>43</td><td>41</td><td></td></tr> <tr><td>40</td><td></td><td>37</td><td></td><td>35</td><td>34</td><td>33</td><td>32</td><td>30</td><td>29</td><td></td><td>27</td><td>26</td><td>24</td><td></td><td>22</td><td>21</td><td>20</td><td>18</td></tr> <tr><td>20</td><td>19</td><td>18</td><td>17</td><td>16</td><td></td><td></td><td>13</td><td>12</td><td></td><td></td><td>8</td><td>6</td><td>5</td><td></td><td>3</td><td>2</td><td></td><td></td></tr> </table>																	78						72	71	70	69	68		66	65	64	63	61		60	59	58	57	56			53	52	50						44	43	41		40		37		35	34	33	32	30	29		27	26	24		22	21	20	18	20	19	18	17	16			13	12			8	6	5		3	2		
	78						72	71	70	69	68		66	65	64	63	61																																																																																	
60	59	58	57	56			53	52	50						44	43	41																																																																																	
40		37		35	34	33	32	30	29		27	26	24		22	21	20	18																																																																																
20	19	18	17	16			13	12			8	6	5		3	2																																																																																		
AVAILABLE	NOT APPLICABLE	34566-8203	G	0	A	BLACK	<table border="1"> <tr><td></td><td>70</td><td></td><td>67</td><td>66</td><td></td><td></td><td></td><td></td><td></td><td></td><td></td><td>58</td><td>56</td><td>55</td><td>54</td><td></td><td></td><td></td></tr> <tr><td></td><td></td><td></td><td>47</td><td></td><td></td><td>44</td><td>43</td><td>42</td><td>41</td><td></td><td>39</td><td></td><td>37</td><td>36</td><td></td><td>34</td><td></td><td></td></tr> <tr><td colspan="2">73</td><td></td><td>31</td><td>30</td><td></td><td></td><td></td><td>27</td><td>25</td><td>24</td><td></td><td></td><td>21</td><td>20</td><td>19</td><td>18</td><td></td><td></td></tr> <tr><td></td><td></td><td></td><td></td><td></td><td></td><td>13</td><td></td><td></td><td></td><td></td><td></td><td></td><td>6</td><td>5</td><td>4</td><td>3</td><td>2</td><td>1</td></tr> </table>																	70		67	66								58	56	55	54							47			44	43	42	41		39		37	36		34			73			31	30				27	25	24			21	20	19	18									13							6	5	4	3	2	1
	70		67	66								58	56	55	54																																																																																			
			47			44	43	42	41		39		37	36		34																																																																																		
73			31	30				27	25	24			21	20	19	18																																																																																		
						13							6	5	4	3	2	1																																																																																
AVAILABLE	NOT APPLICABLE	34566-8303	G	0	A	BLACK	<table border="1"> <tr><td>72</td><td>71</td><td>69</td><td>68</td><td>67</td><td>66</td><td></td><td>64</td><td>63</td><td>62</td><td></td><td>59</td><td>58</td><td>57</td><td>56</td><td></td><td>54</td><td>53</td></tr> <tr><td>52</td><td>51</td><td>50</td><td>49</td><td>48</td><td>47</td><td>46</td><td></td><td>44</td><td>43</td><td>42</td><td></td><td>39</td><td>38</td><td>37</td><td>36</td><td>35</td><td>34</td><td>33</td></tr> <tr><td colspan="2">73</td><td></td><td>32</td><td>31</td><td>30</td><td>29</td><td></td><td></td><td>27</td><td></td><td>24</td><td>23</td><td>22</td><td>21</td><td>20</td><td>19</td><td>18</td><td>17</td></tr> <tr><td></td><td></td><td></td><td>15</td><td>14</td><td>13</td><td>12</td><td>11</td><td></td><td></td><td>9</td><td>8</td><td>7</td><td>6</td><td>5</td><td>4</td><td>3</td><td>2</td><td>1</td></tr> </table>																72	71	69	68	67	66		64	63	62		59	58	57	56		54	53	52	51	50	49	48	47	46		44	43	42		39	38	37	36	35	34	33	73			32	31	30	29			27		24	23	22	21	20	19	18	17				15	14	13	12	11			9	8	7	6	5	4	3	2	1	
72	71	69	68	67	66		64	63	62		59	58	57	56		54	53																																																																																	
52	51	50	49	48	47	46		44	43	42		39	38	37	36	35	34	33																																																																																
73			32	31	30	29			27		24	23	22	21	20	19	18	17																																																																																
			15	14	13	12	11			9	8	7	6	5	4	3	2	1																																																																																

SEE NEXT PAGE FOR ADDITIONAL NUMBERS

<b>ENTER DESCRIPTION</b> EC NO: UAU2010-1551 DRAWN BY: DRWNAH01 CHECKED BY: CHKDRFF1HS APPROVED BY: APPR.VKOSHY DATE: 2010/03/15 DATE: 2008/05/09 DATE: 2010/03/18 F40	QUALITY SYMBOLS ▽=0 ▽=0	GENERAL TOLERANCES (UNLESS SPECIFIED) mm INCH 4 PLACES ±--- ±--- 3 PLACES ±--- ±--- 2 PLACES ±--- ±--- 1 PLACE ±--- ±--- ANGULAR ±---°	DIMENSION STYLE MM ONLY	SCALE 1:1	DESIGN UNITS METRIC	THIRD ANGLE PROJECTION	
	DRAFT WHERE APPLICABLE MUST REMAIN WITHIN DIMENSIONS		DRAWN BY: SRAJENDRANAT CHECKED BY: TSKIVER APPROVED BY: VKOSHY DATE: 2008/05/09 DATE: 2008/05/09 DATE: 2010/03/18	TITLE MX123 73/80 CKT HRNS CONN ASSY	MOLEX INCORPORATED	SHEET NO. 12 OF 36	
	SEE BOM TABLE			MATERIAL NO. SD-34566-001	DOCUMENT NO.	MOLEX INCORPORATED	SHEET NO. 12 OF 36
	THIS DRAWING CONTAINS INFORMATION THAT IS PROPRIETARY TO MOLEX INCORPORATED AND SHOULD NOT BE USED WITHOUT WRITTEN PERMISSION						











20 19 18 17 16 15 14 13 12 11 10 9 8 7 6 5 4 3 2 1

STATUS	GM PART #	MATERIAL #	PART/MATERIAL REVISION	WIRE DRESS OPTION	KEY OPTION	COLOR (TPA)	NUMBERS INDICATE CAVITIES OPEN FOR CIRCUITS																	
AVAILABLE	NOT APPLICABLE	34566-1193	G	0	A	BLACK	72	71	69	68	67	66	64	63	62	60	59					54	53	
							52		49	48	46	44	43	42		39						34	33	
							73		32		29	27			23							17		
											14	13	12	11	9	8	7	6	5	4	3	2	1	
AVAILABLE	NOT APPLICABLE	34566-1213	G	0	A	BLACK	72	71	69	68	67	66	64	63	62		59					54	53	
							52		49	48	46	44	43	42		39						34	33	
							73		32		29	27			24	23						17		
											14	13	12	11	9	8			5	4	3	2	1	
AVAILABLE	NOT APPLICABLE	34566-1223	G	0	B	ST GRY				67	66	65	63	62		59	57	55				53		
										48			43	42		39	37	35				33		
							73					29	27	26		23	21					17		
												12			9	7								
AVAILABLE	NOT APPLICABLE	34566-1233	G	0	B	ST GRY				48	46		42		39	37	35					33		
							73				29		26		23	21						17		
												12			9	7								
AVAILABLE	NOT APPLICABLE	34566-1243	G	0	B	ST GRY			50	48	46					59	57	55				53		
							73					29			23	21						33		
										15		12			7	6	5	4	3			17		
AVAILABLE	NOT APPLICABLE	34566-1253	G	9	B	ST GRY			49	48		65			60	59	57	55				53		
							73				46				40	39	37	35				33		
															24	23	21					2		
AVAILABLE	NOT APPLICABLE	34566-1263	G	9	A	BLACK	72	71	69	68	67	66	64	63	62		59				56		53	
							50		48	46		44	43	42		39					36	35	33	
							73		32	30	29	27			24	23					20	19	17	
										14	13	12	11	9	8					5	4	3	2	1
AVAILABLE	NOT APPLICABLE	34566-1273	G	0	A	BLACK		70	69	68		65	64	63		61	59	58	57	56				
							52	50	49	48	47					41		38	37	36		34	33	
							73		32	31	30	29	28	27		24	23				20	19	18	
									16			13	12	11	10	9							1	

<b>ENTER DESCRIPTION</b> EC NO: UAU2010-1551 DRAWN BY: 2010/03/15 CHKD BY: 2008/05/09 APPR: VKOSHY 2010/03/18 REV: T40	<b>QUALITY SYMBOLS</b> ▽=0 ▽=0	<b>GENERAL TOLERANCES (UNLESS SPECIFIED)</b> <table border="1"> <tr> <th></th> <th>mm</th> <th>INCH</th> </tr> <tr> <td>4 PLACES</td> <td>±---</td> <td>±---</td> </tr> <tr> <td>3 PLACES</td> <td>±---</td> <td>±---</td> </tr> <tr> <td>2 PLACES</td> <td>±---</td> <td>±---</td> </tr> <tr> <td>1 PLACE</td> <td>±---</td> <td>±---</td> </tr> </table>		mm	INCH	4 PLACES	±---	±---	3 PLACES	±---	±---	2 PLACES	±---	±---	1 PLACE	±---	±---	<b>DIMENSION STYLE</b> <b>MM ONLY</b>	<b>SCALE</b> <b>1:1</b>	<b>DESIGN UNITS</b> <b>METRIC</b>	<b>THIRD ANGLE PROJECTION</b>
		mm	INCH																		
	4 PLACES	±---	±---																		
	3 PLACES	±---	±---																		
2 PLACES	±---	±---																			
1 PLACE	±---	±---																			
<b>DRAFT WHERE APPLICABLE MUST REMAIN WITHIN DIMENSIONS</b>	<b>DRAWN BY</b> SRAJENDRANAT 2008/05/09	<b>CHECKED BY</b> TSKIVER 2008/05/09	<b>DATE</b> 2010/03/18	<b>TITLE</b> MX123 73/80 CKT HRNS CONN ASSY	<b>MOLEX INCORPORATED</b>	<b>SHEET NO.</b> 17 OF 36															
<b>SEE BOM TABLE</b>	<b>MATERIAL NO.</b> SD-34566-001	<b>DOCUMENT NO.</b> SD-34566-001	<b>DATE</b> 2010/03/18	<b>MOLEX INCORPORATED</b>	<b>MOLEX INCORPORATED</b>	<b>THIS DRAWING CONTAINS INFORMATION THAT IS PROPRIETARY TO MOLEX INCORPORATED AND SHOULD NOT BE USED WITHOUT WRITTEN PERMISSION</b>															

19 18 17 16 15 14 13 12 11 10 9 8 7 6 5 4 3 2 1

20 19 18 17 16 15 14 13 12 11 10 9 8 7 6 5 4 3 2 1

STATUS	GM PART #	MATERIAL #	PART/MATERIAL REVISION	WIRE DRESS OPTION	KEY OPTION	COLOR (TPA)	NUMBERS INDICATE CAVITIES OPEN FOR CIRCUITS																																																																						
AVAILABLE	NOT APPLICABLE	34566-1283	G	0	A	BLACK	72	71	70	69	68	66	65	64	63	61	59	58	57	56	54	52	50	49	48	47	32	31	30	29	28	27	26	24	23	21	20	19	18	17	16	15	14	13	12	11	10	9																													
AVAILABLE	NOT APPLICABLE	34566-1293	G	0	A	BLACK	72	71	70	69	68	66	65	64	63	61	59	58	57	56	54	52	50	49	48	47	32	31	30	29	28	27	26	24	23	21	20	19	18	17	16	15	14	13	12	11	10	9																													
AVAILABLE	NOT APPLICABLE	34566-1313	G	0	H	ST GRY	80	78	77	76	75	74	73	72	71	70	69	68	66	65	64	63	61	59	58	57	56	55	54	53	40	39	38	37	35	34	32	30	29	27	26	24	23	21	20	19	18	17	16	15	14	13	12	11	10	9	8	7	6	5	4	3	2	1													
AVAILABLE	NOT APPLICABLE	34566-1323	G	0	A	BLACK	72	71	70	69	68	67	66	65	64	63	62	60	59	58	57	56	55	54	53	52	51	50	49	48	47	46	45	44	43	42	41	40	39	38	37	36	35	34	33	32	31	30	29	28	27	26	25	24	23	22	21	20	19	18	17	16	15	14	13	12	11	10	9	8	7	6	5	4	3	2	1
AVAILABLE	NOT APPLICABLE	34566-1333	G	0	A	BLACK	72	71	70	69	68	67	66	65	64	63	62	60	59	58	57	56	55	54	53	52	51	50	49	48	47	46	45	44	43	42	41	40	39	38	37	36	35	34	33	32	31	30	29	28	27	26	25	24	23	22	21	20	19	18	17	16	15	14	13	12	11	10	9	8	7	6	5	4	3	2	1
AVAILABLE	NOT APPLICABLE	34566-1343	G	0	A	BLACK	72	71	70	69	68	67	66	65	64	63	62	60	59	58	57	56	55	54	53	52	51	50	49	48	47	46	45	44	43	42	41	40	39	38	37	36	35	34	33	32	31	30	29	28	27	26	25	24	23	22	21	20	19	18	17	16	15	14	13	12	11	10	9	8	7	6	5	4	3	2	1
AVAILABLE	NOT APPLICABLE	34566-1353	G	0	H	ST GRY	79	78	77	76	75	74	73	72	71	70	69	68	66	65	64	63	61	59	58	57	56	55	54	53	40	39	38	37	35	34	32	30	29	27	26	24	23	21	20	19	18	17	16	15	14	13	12	11	10	9	8	7	6	5	4	3	2	1													
AVAILABLE	NOT APPLICABLE	34566-1363	G	0	A	BLACK	72	71	70	69	68	67	66	65	64	63	62	60	59	58	57	56	55	54	53	52	51	50	49	48	47	46	45	44	43	42	41	40	39	38	37	36	35	34	33	32	31	30	29	28	27	26	25	24	23	22	21	20	19	18	17	16	15	14	13	12	11	10	9	8	7	6	5	4	3	2	1

<b>ENTER DESCRIPTION</b> EC NO: UAU2010-1551 DRAWN BY: 2010/03/15 CHKDGR: FFH 2008/05/09 APPR: VKOSHY 2010/03/18 REV: T40	<b>QUALITY SYMBOLS</b> ▽=0 ▽=0	<b>GENERAL TOLERANCES (UNLESS SPECIFIED)</b> 4 PLACES ±--- INCH 3 PLACES ±--- INCH 2 PLACES ±--- INCH 1 PLACE ±--- INCH ANGULAR ±---°	<b>DIMENSION STYLE</b> <b>MM ONLY</b>	<b>SCALE</b> <b>1:1</b>	<b>DESIGN UNITS</b> <b>METRIC</b>	<b>THIRD ANGLE PROJECTION</b>
	<b>DRAFT WHERE APPLICABLE MUST REMAIN WITHIN DIMENSIONS</b>	<b>SEE BOM TABLE</b>	<b>MOLEX INCORPORATED</b>	<b>MX123</b> <b>73/80 CKT</b> <b>HRNS CONN ASSY</b>	<b>SD-34566-001</b>	<b>SHEET NO.</b> <b>18 OF 36</b>
	<b>THIS DRAWING CONTAINS INFORMATION THAT IS PROPRIETARY TO MOLEX INCORPORATED AND SHOULD NOT BE USED WITHOUT WRITTEN PERMISSION</b>	<b>SIZE D</b>	<b>MOLEX INCORPORATED</b>	<b>73/80 CKT</b> <b>HRNS CONN ASSY</b>	<b>SD-34566-001</b>	<b>SHEET NO.</b> <b>18 OF 36</b>
	<b>THIS DRAWING CONTAINS INFORMATION THAT IS PROPRIETARY TO MOLEX INCORPORATED AND SHOULD NOT BE USED WITHOUT WRITTEN PERMISSION</b>	<b>SIZE D</b>	<b>MOLEX INCORPORATED</b>	<b>73/80 CKT</b> <b>HRNS CONN ASSY</b>	<b>SD-34566-001</b>	<b>SHEET NO.</b> <b>18 OF 36</b>

19 18 17 16 15 14 13 12 11 10 9 8 7 6 5 4 3 2 1









20 19 18 17 16 15 14 13 12 11 10 9 8 7 6 5 4 3 2 1

STATUS	GM PART #	MATERIAL #	PART/MATERIAL REVISION	WIRE DRESS OPTION	KEY OPTION	COLOR (TPA)	NUMBERS INDICATE CAVITIES OPEN FOR CIRCUITS																		
AVAILABLE	NOT APPLICABLE	34566-1773	G	0	C	BLUE	72	70		67	66		63	62		59	57					53			
							52	51			46	44		42	40	39						34	33		
							73				30			27	26	25			22	21	20				
										15	14			10	9			6	5	4					
AVAILABLE	NOT APPLICABLE	34566-1783	G	0	C	BLUE	72	70		67	66		63	62		59	57					53			
							52	51			46	44		42	40	39						34	33		
							73				30			26	25			22	21	20					
										15	14			10	9			6	5	4					
AVAILABLE	NOT APPLICABLE	34566-1793	G	0	A	BLACK			69				63	62	61		58	57	56	55	54	53			
							52	51	49				44	43	42	41			37	36	35	34	33		
							73				32		29	28	27	26					19	18			
										16		13	12	11	10						3				
AVAILABLE	NOT APPLICABLE	34566-1813	G	0	B	ST GRAY	72	71	70	68	67	66		62	61	60	59	58	57	56	55	54	53		
							52	51	50	48	47	46		42	41	40	39	38	37	36	35	34	33		
							73				32	31	30	29	28	27	26	25	24	23					
										16	15	14	13		10	9	8								
AVAILABLE	NOT APPLICABLE	34566-1823	G	0	A	BLACK	72	71	70	69	68	66	65	64		61	59	58	56	55	54	53			
							52	50	49		47				42	41		38	37	36		34	33		
							73				32	31	30	29	28	27	26	24	23	22	21	20	19	18	17
										16		13	12	11	10	9	8							1	
AVAILABLE	NOT APPLICABLE	34566-1833	G	0	A	BLACK				68		65	63	61	59	58	56					34	33		
							52	50			47				41		38	37	36						
							73				32	31	30	29	28	27	25	24	23			20	19	18	17
										16		13	12	11	10									1	
AVAILABLE	NOT APPLICABLE	34566-1843	G	0	A	BLACK				68		65	63	61	59	58	56					53			
							52	50			47				41		38	37	36						
							73				32	31	30	29	28	27	24	23	22	21	20	19	18	17	
										16	15	14	13	12	11	10								1	
AVAILABLE	NOT APPLICABLE	34566-1853	G	0	A	BLACK	72	70	69	68	67		65	63	61	60		57	56	55	54	53			
							52	50	49	48	47		44	43	41	40			37	36	35	34	33		
							73				30	29	28		25	24			21	20	19	18	17		
										16	15			11	10	9	8	7	6	5	4	3	2	1	
AVAILABLE	NOT APPLICABLE	34566-1863	G	0	B	ST GRAY				68	67	66	65	64	63										
															43										
							73				32	30	29	28	27								17		
										16					10										

<b>ENTER DESCRIPTION</b> EC NO: UAU2010-1551 DRAWN BY: DRWNAH01 CHECKED BY: CHKDRFF1 APPROVED BY: APPR.VKOSHY DATE: 2010/03/15 DATE: 2008/05/09 DATE: 2010/03/18 REV: T40	<b>QUALITY SYMBOLS</b> ▽=0 ▽=0	<b>GENERAL TOLERANCES (UNLESS SPECIFIED)</b> <table border="1"> <tr> <th></th> <th>mm</th> <th>INCH</th> </tr> <tr> <td>4 PLACES</td> <td>±---</td> <td>±---</td> </tr> <tr> <td>3 PLACES</td> <td>±---</td> <td>±---</td> </tr> <tr> <td>2 PLACES</td> <td>±---</td> <td>±---</td> </tr> <tr> <td>1 PLACE</td> <td>±---</td> <td>±---</td> </tr> </table>		mm	INCH	4 PLACES	±---	±---	3 PLACES	±---	±---	2 PLACES	±---	±---	1 PLACE	±---	±---	<b>DIMENSION STYLE</b> <b>MM ONLY</b>	<b>SCALE</b> <b>1:1</b>	<b>DESIGN UNITS</b> <b>METRIC</b>	<b>THIRD ANGLE PROJECTION</b>
		mm	INCH																		
	4 PLACES	±---	±---																		
	3 PLACES	±---	±---																		
2 PLACES	±---	±---																			
1 PLACE	±---	±---																			
			<b>DRAWN BY</b> SRAJENDRANAT	<b>DATE</b> 2008/05/09	<b>TITLE</b> MX123 73/80 CKT HRNS CONN ASSY																
			<b>CHECKED BY</b> TSKIVER	<b>DATE</b> 2008/05/09	<b>MOLEX INCORPORATED</b>																
			<b>APPROVED BY</b> VKOSHY	<b>DATE</b> 2010/03/18	<b>SD-34566-001</b>																
		<b>DRAFT WHERE APPLICABLE MUST REMAIN WITHIN DIMENSIONS</b>	<b>SEE BOM TABLE</b>	<b>MATERIAL NO.</b> SD-34566-001	<b>DOCUMENT NO.</b>	<b>SHEET NO.</b> 23 OF 36															
<b>THIS DRAWING CONTAINS INFORMATION THAT IS PROPRIETARY TO MOLEX INCORPORATED AND SHOULD NOT BE USED WITHOUT WRITTEN PERMISSION</b>																					

19 18 17 16 15 14 13 12 11 10 9 8 7 6 5 4 3 2 1



20 19 18 17 16 15 14 13 12 11 10 9 8 7 6 5 4 3 2 1

STATUS	GM PART #	MATERIAL #	PART/MATERIAL REVISION	WIRE DRESS OPTION	KEY OPTION	COLOR (TPA)	NUMBERS INDICATE CAVITIES OPEN FOR CIRCUITS															
AVAILABLE	NOT APPLICABLE	34566-1873	G	0	C	BLUE	72	70		67	66		63	62		59	57			53		
							52	51			46	44	42	40	39				34	33		
							73			32	30		27	26	25		22	21	20			
										15	14			10	9		6	5	4			
AVAILABLE	NOT APPLICABLE	34566-1883	G	0	A	BLACK		70	68	67	66	65					58	57	55			
									49	47	46	44	43	42	41	40	39	37	35			
							73			32	30		27	26	25	24		21	20	19		
										16	15	13		10	9	8	6	5	4	3		
																				2		
																				1		
AVAILABLE	NOT APPLICABLE	34566-1893	G	0	C	BLUE	72	70			66		63			59	57			53		
							52	51			46	44	42	40	39				34	33		
							73			32	30		27	26	25		22	21	20			
										15	14			10	9		6	5	4			
AVAILABLE	NOT APPLICABLE	34566-1913	G	0	B	ST GRY	72	70	68	66					60	59			55	54		
							52	50	48	46					40	39			35	34		
							73			32	31	30	29	28	27	26	25	24				
										16					10	9	8					
AVAILABLE	NOT APPLICABLE	34566-1923	G	0	A	BLACK			69				63				58	56	55	54		
							52	51	49				44	43	42	41			36	35		
							73			32			28	26					19	18		
										16			12	10					3			
AVAILABLE	NOT APPLICABLE	34566-1933	G	0	A	BLACK		70		67	66	65					58	57	55			
									49	47	46	44	43	42	41	40	39	37	35			
							73			32	30		27	26	25	24		21	20	19		
										16	15	13		10	9	8	6	5	4	3		
																				2		
																				1		
AVAILABLE	NOT APPLICABLE	34566-1943	G	0	A	BLACK		70		67	66	65					58	57	55			
							51	49		47	46	44	43	42	41	40	39	37	35			
							73			32	30		27	26	25	24		21	20	19		
										16	15	13		10	9	8	6	5	4	3		
																				2		
																				1		
AVAILABLE	NOT APPLICABLE	34566-1953	G	0	C	BLUE	72	70			66		63			59	57			53		
							52	51		48	47	46	44	42	40	39				34		
							73				30		26	25			22	21	20			
										15	14			10	9		6	5	4			
AVAILABLE	NOT APPLICABLE	34566-1963	G	0	C	BLUE	72	70			66		63			59	57			53		
							52	51			46	44	42	40	39					34		
							73				30		26	25			22	21	20			
										15	14			10	9		6	5	4			

<b>ENTER DESCRIPTION</b> EC NO: UAU2010-1551 DRAWN BY: DRWNAH01 CHECKED BY: CHKDRFF1HS APPROVED BY: APPR.VKOSHY DATE: 2010/03/15 DATE: 2008/05/09 DATE: 2010/03/18 REV: F40	<b>QUALITY SYMBOLS</b> ▽=0 ▽=0	<b>GENERAL TOLERANCES (UNLESS SPECIFIED)</b> <table border="1"> <tr> <th></th> <th>mm</th> <th>INCH</th> </tr> <tr> <td>4 PLACES</td> <td>±---</td> <td>±---</td> </tr> <tr> <td>3 PLACES</td> <td>±---</td> <td>±---</td> </tr> <tr> <td>2 PLACES</td> <td>±---</td> <td>±---</td> </tr> <tr> <td>1 PLACE</td> <td>±---</td> <td>±---</td> </tr> </table> ANGULAR ±---°		mm	INCH	4 PLACES	±---	±---	3 PLACES	±---	±---	2 PLACES	±---	±---	1 PLACE	±---	±---	<b>DIMENSION STYLE</b> <b>MM ONLY</b>	<b>SCALE</b> <b>1:1</b>	<b>DESIGN UNITS</b> <b>METRIC</b>	<b>THIRD ANGLE PROJECTION</b>
		mm	INCH																		
	4 PLACES	±---	±---																		
	3 PLACES	±---	±---																		
2 PLACES	±---	±---																			
1 PLACE	±---	±---																			
			<b>DRAWN BY</b> SRAJENDRANAT	<b>DATE</b> 2008/05/09	<b>TITLE</b> MX123 73/80 CKT HRNS CONN ASSY																
			<b>CHECKED BY</b> TSKIVER	<b>DATE</b> 2008/05/09	<b>MATERIAL NO.</b> SD-34566-001																
			<b>APPROVED BY</b> VKOSHY	<b>DATE</b> 2010/03/18	<b>DOCUMENT NO.</b> SD-34566-001	<b>SHEET NO.</b> 24 OF 36															

19 18 17 16 15 14 13 12 11 10 9 8 7 6 5 4 3 2 1







20	19	18	17	16	15	14	13	12	11	10	9	8	7	6	5	4	3	2	1										
										STATUS	GM PART #	MATERIAL #	PART / MATERIAL REVISION	WIRE DRESS OPTION	KEY OPTION	COLOR (TPA)	NUMBERS INDICATE CAVITIES OPEN FOR CIRCUITS												
										AVAILABLE	NOT APPLICABLE	34566-2293	G	0	C	BLUE	72 70 68 66 63 59 57 53 52 51 48 47 46 44 42 40 39 34 33 73 30 26 25 22 21 6												
										AVAILABLE	NOT APPLICABLE	34566-2319	G	0	C	BLUE	72 70 66 63 59 57 53 52 51 46 44 42 40 39 34 33 73 30 26 25 22 21 6												
										AVAILABLE	NOT APPLICABLE	34566-2323	G	0	C	BLUE	72 70 68 66 63 59 57 53 52 51 48 47 46 44 42 40 39 34 33 73 30 26 25 22 21 20 6 5 4												
										AVAILABLE	NOT APPLICABLE	34566-2333	G	0	A	BLACK	71 69 68 65 64 63 61 59 57 56 54 53 52 50 49 47 46 45 44 43 42 41 39 38 37 36 34 33 73 32 31 30 29 28 27 24 23 22 20 19 18 16 15 14 13 12 11 10 9 8 7 6 5 4 3 2 1												
										AVAILABLE	NOT APPLICABLE	34566-2343	G	0	A	BLACK	72 70 68 67 66 65 64 63 62 61 59 57 55 53 52 51 49 47 46 45 44 43 42 41 39 37 35 34 33 73 32 30 27 25 24 21 20 19 18 17 16 15 14 13 9 8 6 5 3 1												
										AVAILABLE	NOT APPLICABLE	34566-2353	G	0	A	BLACK	72 70 67 66 65 64 63 62 61 59 57 55 53 52 51 49 47 46 45 44 43 42 41 39 37 35 34 33 73 32 30 27 25 24 21 20 19 18 17 16 15 14 13 9 8 6 5 3 1												
										AVAILABLE	NOT APPLICABLE	34566-2363	G	0	C	BLUE	72 70 67 66 63 62 59 57 53 52 51 46 44 42 40 39 38 34 33 73 32 30 27 26 25 22 21 20 6 5 4												
										AVAILABLE	NOT APPLICABLE	34566-2373	G	0	B	ST GRAY	68 67 66 65 64 61 60 59 58 57 55 54 53 51 50 49 48 47 46 45 43 42 41 40 39 38 37 35 34 33 73 32 31 30 26 24 23 22 21 20 19 18 16 15 14 13 10 9 8 7 6 5 4 3 2												
										AVAILABLE	NOT APPLICABLE	34566-2383	G	0	B	ST GRAY	65 59 57 55 53 50 49 48 46 44 43 42 41 39 38 37 35 34 33 73 15 29 24 23 21 7 6 5 4 3												

<b>ENTER DESCRIPTION</b> EC NO: UAU2010-151 DRAWN BY: SRAJENDRANAT CHECKED BY: TSK IVER APPROVED BY: VKOSHY DATE: 2010/03/18 SHEET NO: 28 OF 36	QUALITY SYMBOLS ◻=0 ◻=1 ◻=2 ◻=3 ◻=4 ◻=5 ◻=6 ◻=7 ◻=8 ◻=9 ◻=10 ◻=11 ◻=12 ◻=13 ◻=14 ◻=15 ◻=16 ◻=17 ◻=18 ◻=19 ◻=20	GENERAL TOLERANCES (UNLESS SPECIFIED) DIMENSION STYLE: <b>MM ONLY</b> SCALE: <b>1:1</b> DESIGN UNITS: <b>METRIC</b> THIRD ANGLE PROJECTION	DRAWN BY: SRAJENDRANAT CHECKED BY: TSK IVER APPROVED BY: VKOSHY DATE: 2010/03/18 MATERIAL NO.: DOCUMENT NO.: SHEET NO.: 28 OF 36	
	4 PLACES ±---+ 3 PLACES ±---+ 2 PLACES ±---+ 1 PLACE ±---+ ANGULAR ±---0	min INCH ±---+ ±---+ ±---+ ±---+ ±---0	TITLE: <b>MX123 73/80 CKT HRNS CONN ASSY</b> MOLEX INCORPORATED	SEE BOM TABLE THIS DRAWING CONTAINS INFORMATION THAT IS PROPRIETARY TO MOLEX INCORPORATED AND SHOULD NOT BE USED WITHOUT WRITTEN PERMISSION
	DRAFT WHERE APPLICABLE MUST REMAIN WITHIN DIMENSIONS			DRAFT WHERE APPLICABLE MUST REMAIN WITHIN DIMENSIONS
	DRAFT WHERE APPLICABLE MUST REMAIN WITHIN DIMENSIONS			



STATUS	GM PART #	MATERIAL #	PART / MATERIAL REVISION	WIRE DRESS OPTION	KEY OPTION	COLOR (TPA)	NUMBERS INDICATE CAVITIES OPEN FOR CIRCUITS																																																																																			
AVAILABLE	NOT APPLICABLE	34566-2483	G	0	A	BLACK	<table border="1"> <tr><td></td><td></td><td>69</td><td></td><td></td><td></td><td>63</td><td>62</td><td>61</td><td></td><td>58</td><td>57</td><td>56</td><td>55</td><td>54</td><td>53</td></tr> <tr><td>52</td><td>51</td><td>49</td><td></td><td></td><td></td><td>44</td><td>43</td><td>42</td><td>41</td><td></td><td>37</td><td>36</td><td>35</td><td>34</td><td>33</td></tr> <tr><td colspan="2"></td><td>73</td><td>32</td><td>29</td><td>28</td><td>27</td><td>26</td><td></td><td>23</td><td></td><td></td><td>19</td><td>18</td><td></td><td></td></tr> <tr><td colspan="2"></td><td></td><td>16</td><td></td><td>13</td><td>12</td><td>11</td><td>10</td><td>8</td><td></td><td></td><td></td><td>3</td><td></td><td></td></tr> </table>			69				63	62	61		58	57	56	55	54	53	52	51	49				44	43	42	41		37	36	35	34	33			73	32	29	28	27	26		23			19	18						16		13	12	11	10	8				3																					
		69				63	62	61		58	57	56	55	54	53																																																																											
52	51	49				44	43	42	41		37	36	35	34	33																																																																											
		73	32	29	28	27	26		23			19	18																																																																													
			16		13	12	11	10	8				3																																																																													
AVAILABLE	NOT APPLICABLE	34566-2493	G	0	B	ST GRAY	<table border="1"> <tr><td>72</td><td>71</td><td>70</td><td>68</td><td>67</td><td>66</td><td></td><td></td><td>62</td><td>61</td><td>60</td><td>59</td><td>58</td><td>57</td><td>56</td><td>55</td><td>54</td><td>53</td></tr> <tr><td>52</td><td>51</td><td>50</td><td>48</td><td>47</td><td>46</td><td></td><td></td><td>42</td><td>41</td><td>40</td><td>39</td><td>38</td><td>37</td><td>36</td><td>35</td><td>34</td><td>33</td></tr> <tr><td colspan="2"></td><td>73</td><td>32</td><td>31</td><td>30</td><td>29</td><td>28</td><td>27</td><td>26</td><td>25</td><td>24</td><td></td><td></td><td></td><td></td><td></td><td>17</td></tr> <tr><td colspan="2"></td><td></td><td>16</td><td>15</td><td>14</td><td>13</td><td></td><td></td><td>10</td><td>8</td><td></td><td></td><td></td><td></td><td></td><td></td><td>2</td><td>1</td></tr> </table>	72	71	70	68	67	66			62	61	60	59	58	57	56	55	54	53	52	51	50	48	47	46			42	41	40	39	38	37	36	35	34	33			73	32	31	30	29	28	27	26	25	24						17				16	15	14	13			10	8							2	1										
72	71	70	68	67	66			62	61	60	59	58	57	56	55	54	53																																																																									
52	51	50	48	47	46			42	41	40	39	38	37	36	35	34	33																																																																									
		73	32	31	30	29	28	27	26	25	24						17																																																																									
			16	15	14	13			10	8							2	1																																																																								
AVAILABLE	NOT APPLICABLE	34566-2513	G	0	C	BLUE	<table border="1"> <tr><td>72</td><td>71</td><td>70</td><td>68</td><td>67</td><td>66</td><td></td><td></td><td>63</td><td>62</td><td></td><td>59</td><td>57</td><td></td><td></td><td></td><td></td><td>53</td></tr> <tr><td>52</td><td>51</td><td></td><td>48</td><td>47</td><td>46</td><td></td><td>44</td><td></td><td>42</td><td>40</td><td>39</td><td></td><td></td><td></td><td></td><td></td><td>34</td><td>33</td></tr> <tr><td colspan="2"></td><td>73</td><td>32</td><td></td><td>30</td><td></td><td></td><td>27</td><td>26</td><td>25</td><td></td><td>22</td><td>21</td><td>20</td><td></td><td></td><td></td><td></td></tr> <tr><td colspan="2"></td><td></td><td></td><td>15</td><td>14</td><td></td><td></td><td></td><td>10</td><td>9</td><td></td><td>6</td><td>5</td><td>4</td><td></td><td></td><td></td><td></td></tr> </table>	72	71	70	68	67	66			63	62		59	57					53	52	51		48	47	46		44		42	40	39						34	33			73	32		30			27	26	25		22	21	20									15	14				10	9		6	5	4												
72	71	70	68	67	66			63	62		59	57					53																																																																									
52	51		48	47	46		44		42	40	39						34	33																																																																								
		73	32		30			27	26	25		22	21	20																																																																												
				15	14				10	9		6	5	4																																																																												
AVAILABLE	NOT APPLICABLE	34566-2523	G	0	A	BLACK	<table border="1"> <tr><td>72</td><td>71</td><td>70</td><td>69</td><td>68</td><td>67</td><td>66</td><td>65</td><td>64</td><td>63</td><td>62</td><td>60</td><td>59</td><td></td><td></td><td></td><td>55</td><td>54</td><td>53</td></tr> <tr><td>52</td><td></td><td>49</td><td>48</td><td></td><td>45</td><td>44</td><td>43</td><td>42</td><td>41</td><td>40</td><td>39</td><td></td><td></td><td></td><td></td><td>35</td><td>34</td><td>33</td></tr> <tr><td colspan="2"></td><td>73</td><td>32</td><td></td><td>29</td><td>28</td><td>27</td><td></td><td>25</td><td>24</td><td>23</td><td></td><td></td><td></td><td></td><td>19</td><td>18</td><td>17</td></tr> <tr><td colspan="2"></td><td></td><td>16</td><td></td><td></td><td>13</td><td>12</td><td>11</td><td></td><td>9</td><td>8</td><td>7</td><td>6</td><td>5</td><td>4</td><td>3</td><td>2</td><td>1</td></tr> </table>	72	71	70	69	68	67	66	65	64	63	62	60	59				55	54	53	52		49	48		45	44	43	42	41	40	39					35	34	33			73	32		29	28	27		25	24	23					19	18	17				16			13	12	11		9	8	7	6	5	4	3	2	1							
72	71	70	69	68	67	66	65	64	63	62	60	59				55	54	53																																																																								
52		49	48		45	44	43	42	41	40	39					35	34	33																																																																								
		73	32		29	28	27		25	24	23					19	18	17																																																																								
			16			13	12	11		9	8	7	6	5	4	3	2	1																																																																								
AVAILABLE	NOT APPLICABLE	34566-2533	G	0	B	ST GRAY	<table border="1"> <tr><td></td><td></td><td></td><td>67</td><td>66</td><td>65</td><td>63</td><td></td><td></td><td></td><td>59</td><td>58</td><td>57</td><td>56</td><td>55</td><td></td><td></td><td></td><td>53</td></tr> <tr><td></td><td></td><td>50</td><td>49</td><td>48</td><td>46</td><td>45</td><td>43</td><td></td><td></td><td>39</td><td>38</td><td>37</td><td>36</td><td>35</td><td>34</td><td></td><td></td><td>33</td></tr> <tr><td colspan="2"></td><td>73</td><td></td><td></td><td>29</td><td>27</td><td></td><td></td><td></td><td></td><td>23</td><td>22</td><td>21</td><td></td><td></td><td></td><td></td><td>18</td></tr> <tr><td colspan="2"></td><td></td><td>16</td><td>15</td><td>14</td><td>13</td><td></td><td></td><td></td><td>8</td><td>7</td><td>6</td><td>5</td><td>4</td><td>3</td><td></td><td></td><td></td></tr> </table>				67	66	65	63				59	58	57	56	55				53			50	49	48	46	45	43			39	38	37	36	35	34			33			73			29	27					23	22	21					18				16	15	14	13				8	7	6	5	4	3										
			67	66	65	63				59	58	57	56	55				53																																																																								
		50	49	48	46	45	43			39	38	37	36	35	34			33																																																																								
		73			29	27					23	22	21					18																																																																								
			16	15	14	13				8	7	6	5	4	3																																																																											
AVAILABLE	NOT APPLICABLE	34566-2543	G	0	C	BLUE	<table border="1"> <tr><td>72</td><td>71</td><td>70</td><td></td><td></td><td>66</td><td></td><td></td><td>63</td><td></td><td></td><td>59</td><td>57</td><td></td><td></td><td></td><td></td><td></td><td>53</td></tr> <tr><td>52</td><td>51</td><td></td><td></td><td></td><td>46</td><td></td><td>44</td><td></td><td>42</td><td>40</td><td>39</td><td></td><td></td><td></td><td></td><td></td><td></td><td>34</td><td>33</td></tr> <tr><td colspan="2"></td><td>73</td><td>32</td><td></td><td>30</td><td></td><td></td><td>27</td><td>26</td><td>25</td><td></td><td>22</td><td>21</td><td></td><td></td><td></td><td></td><td></td><td></td></tr> <tr><td colspan="2"></td><td></td><td></td><td>15</td><td>14</td><td></td><td></td><td></td><td>10</td><td>9</td><td></td><td>6</td><td></td><td></td><td></td><td></td><td></td><td></td><td></td></tr> </table>	72	71	70			66			63			59	57						53	52	51				46		44		42	40	39							34	33			73	32		30			27	26	25		22	21											15	14				10	9		6											
72	71	70			66			63			59	57						53																																																																								
52	51				46		44		42	40	39							34	33																																																																							
		73	32		30			27	26	25		22	21																																																																													
				15	14				10	9		6																																																																														
AVAILABLE	NOT APPLICABLE	34566-2553	G	9	B	ST GRAY	<table border="1"> <tr><td>72</td><td>71</td><td>70</td><td>68</td><td>67</td><td>66</td><td></td><td></td><td>62</td><td>61</td><td>60</td><td>59</td><td>58</td><td>57</td><td>56</td><td>55</td><td>54</td><td>53</td></tr> <tr><td>52</td><td>51</td><td>50</td><td>48</td><td>47</td><td>46</td><td></td><td></td><td>42</td><td>41</td><td>40</td><td>39</td><td>38</td><td>37</td><td>36</td><td>35</td><td>34</td><td>33</td></tr> <tr><td colspan="2"></td><td>73</td><td>32</td><td>31</td><td>30</td><td>29</td><td>28</td><td>27</td><td>26</td><td>25</td><td>24</td><td>23</td><td></td><td></td><td></td><td></td><td></td><td></td></tr> <tr><td colspan="2"></td><td></td><td>16</td><td>15</td><td>14</td><td>13</td><td></td><td></td><td>10</td><td>9</td><td>8</td><td></td><td></td><td></td><td></td><td></td><td></td><td></td></tr> </table>	72	71	70	68	67	66			62	61	60	59	58	57	56	55	54	53	52	51	50	48	47	46			42	41	40	39	38	37	36	35	34	33			73	32	31	30	29	28	27	26	25	24	23										16	15	14	13			10	9	8																
72	71	70	68	67	66			62	61	60	59	58	57	56	55	54	53																																																																									
52	51	50	48	47	46			42	41	40	39	38	37	36	35	34	33																																																																									
		73	32	31	30	29	28	27	26	25	24	23																																																																														
			16	15	14	13			10	9	8																																																																															
AVAILABLE	NOT APPLICABLE	34566-2563	G	9	A	BLACK	<table border="1"> <tr><td></td><td></td><td>69</td><td></td><td></td><td></td><td></td><td></td><td>63</td><td>62</td><td>61</td><td></td><td>58</td><td>57</td><td>56</td><td>55</td><td>54</td><td>53</td></tr> <tr><td>52</td><td>51</td><td>50</td><td>49</td><td></td><td></td><td></td><td></td><td>44</td><td>43</td><td>42</td><td>41</td><td></td><td></td><td></td><td></td><td>37</td><td>36</td><td>35</td><td>34</td><td>33</td></tr> <tr><td colspan="2"></td><td>73</td><td>32</td><td></td><td>29</td><td>28</td><td>27</td><td>26</td><td></td><td></td><td></td><td></td><td></td><td></td><td></td><td>19</td><td>18</td><td></td><td></td><td></td></tr> <tr><td colspan="2"></td><td></td><td>16</td><td></td><td>14</td><td>13</td><td>12</td><td>11</td><td>10</td><td></td><td></td><td></td><td></td><td></td><td></td><td>3</td><td></td><td></td><td></td><td></td></tr> </table>			69						63	62	61		58	57	56	55	54	53	52	51	50	49					44	43	42	41					37	36	35	34	33			73	32		29	28	27	26								19	18							16		14	13	12	11	10							3						
		69						63	62	61		58	57	56	55	54	53																																																																									
52	51	50	49					44	43	42	41					37	36	35	34	33																																																																						
		73	32		29	28	27	26								19	18																																																																									
			16		14	13	12	11	10							3																																																																										
AVAILABLE	NOT APPLICABLE	34566-2573	G	9	C	BLUE	<table border="1"> <tr><td>72</td><td>71</td><td>70</td><td></td><td></td><td>67</td><td>66</td><td></td><td></td><td>63</td><td>62</td><td></td><td>59</td><td>57</td><td></td><td></td><td></td><td></td><td></td><td>53</td></tr> <tr><td>52</td><td>51</td><td></td><td></td><td></td><td>46</td><td>44</td><td></td><td></td><td>42</td><td>40</td><td>39</td><td></td><td></td><td></td><td></td><td></td><td></td><td></td><td>34</td><td>33</td></tr> <tr><td colspan="2"></td><td>73</td><td></td><td></td><td>30</td><td></td><td></td><td></td><td>26</td><td>25</td><td></td><td>22</td><td>21</td><td>20</td><td></td><td></td><td></td><td></td><td></td><td></td></tr> <tr><td colspan="2"></td><td></td><td></td><td>15</td><td>14</td><td></td><td></td><td></td><td>10</td><td>9</td><td></td><td>6</td><td>5</td><td>4</td><td></td><td></td><td></td><td></td><td></td><td></td></tr> </table>	72	71	70			67	66			63	62		59	57						53	52	51				46	44			42	40	39								34	33			73			30				26	25		22	21	20											15	14				10	9		6	5	4						
72	71	70			67	66			63	62		59	57						53																																																																							
52	51				46	44			42	40	39								34	33																																																																						
		73			30				26	25		22	21	20																																																																												
				15	14				10	9		6	5	4																																																																												

<b>ENTER DESCRIPTION</b> TEC NO. JAU2010-1551 DRAWN BY CHYKORFF JHS 2008/05/09 CHECKED BY APPR:VKOSHY 2010/03/18 REV: 40	QUALITY SYMBOLS ▽=0 ▽=0	GENERAL TOLERANCES (UNLESS SPECIFIED) mm INCH 4 PLACES ±--- ±--- 3 PLACES ±--- ±--- 2 PLACES ±--- ±--- 1 PLACE ±--- ±--- ANGULAR ±---°	DIMENSION STYLE <b>MM ONLY</b>	SCALE <b>1:1</b>	DESIGN UNITS <b>METRIC</b>	THIRD ANGLE PROJECTION 	
	DRAWN BY DATE SRAJENDRANAT 2008/05/09		CHECKED BY DATE TSK IVER 2008/05/09		APPROVED BY DATE VKOSHY 2010/03/18		MATERIAL NO. DATE MOLEX INCORPORATED
	DRAFT WHERE APPLICABLE MUST REMAIN WITHIN DIMENSIONS		SEE BOM TABLE		DOCUMENT NO. SHEET NO. SD-34566-001 30 OF 36		TITLE MX123 73/80 CKT HRNS CONN ASSY
	THIS DRAWING CONTAINS INFORMATION THAT IS PROPRIETARY TO MOLEX INCORPORATED AND SHOULD NOT BE USED WITHOUT WRITTEN PERMISSION						

STATUS	GM PART #	MATERIAL #	PART/MATERIAL REVISION	WIRE DRESS OPTION	KEY OPTION	COLOR (TPA)	NUMBERS INDICATE CAVITIES OPEN FOR CIRCUITS																																																																														
AVAILABLE	NOT APPLICABLE	34566-2583	G	0	A	BLACK	<table border="1"> <tr><td></td><td></td><td>69</td><td></td><td></td><td></td><td>63</td><td></td><td></td><td>58</td><td>56</td><td>55</td><td>54</td><td>53</td></tr> <tr><td>52</td><td>51</td><td>50</td><td>49</td><td></td><td></td><td>44</td><td>43</td><td>42</td><td>41</td><td>39</td><td></td><td>36</td><td>35</td><td>34</td><td>33</td></tr> <tr><td></td><td></td><td>73</td><td>32</td><td></td><td></td><td>28</td><td>26</td><td></td><td></td><td></td><td></td><td>19</td><td>18</td><td></td><td></td></tr> <tr><td></td><td></td><td></td><td>16</td><td>14</td><td></td><td>12</td><td>10</td><td></td><td></td><td></td><td></td><td></td><td>3</td><td></td><td></td></tr> </table>			69				63			58	56	55	54	53	52	51	50	49			44	43	42	41	39		36	35	34	33			73	32			28	26					19	18						16	14		12	10						3																		
		69				63			58	56	55	54	53																																																																								
52	51	50	49			44	43	42	41	39		36	35	34	33																																																																						
		73	32			28	26					19	18																																																																								
			16	14		12	10						3																																																																								
AVAILABLE	NOT APPLICABLE	34566-2593	G	0	C	BLUE	<table border="1"> <tr><td>72</td><td>70</td><td></td><td></td><td>66</td><td></td><td>63</td><td>62</td><td></td><td>59</td><td>57</td><td></td><td></td><td></td><td></td><td>53</td></tr> <tr><td>52</td><td>51</td><td></td><td></td><td>46</td><td>44</td><td>42</td><td>41</td><td>40</td><td>39</td><td></td><td></td><td></td><td></td><td>34</td><td>33</td></tr> <tr><td></td><td></td><td>73</td><td>32</td><td>30</td><td></td><td>27</td><td>26</td><td>25</td><td></td><td>22</td><td>21</td><td></td><td></td><td></td><td></td></tr> <tr><td></td><td></td><td></td><td>15</td><td>14</td><td></td><td></td><td>10</td><td>9</td><td></td><td>6</td><td></td><td></td><td></td><td></td><td></td></tr> </table>	72	70			66		63	62		59	57					53	52	51			46	44	42	41	40	39					34	33			73	32	30		27	26	25		22	21								15	14			10	9		6																			
72	70			66		63	62		59	57					53																																																																						
52	51			46	44	42	41	40	39					34	33																																																																						
		73	32	30		27	26	25		22	21																																																																										
			15	14			10	9		6																																																																											
AVAILABLE	NOT APPLICABLE	34566-2613	G	9	C	BLUE	<table border="1"> <tr><td>72</td><td>70</td><td></td><td>67</td><td>66</td><td></td><td>63</td><td>62</td><td></td><td>59</td><td>57</td><td></td><td></td><td></td><td></td><td>53</td></tr> <tr><td>52</td><td>51</td><td></td><td></td><td>46</td><td>44</td><td>42</td><td>41</td><td>40</td><td>39</td><td></td><td></td><td></td><td></td><td>34</td><td>33</td></tr> <tr><td></td><td></td><td>73</td><td></td><td>30</td><td></td><td>27</td><td>26</td><td>25</td><td></td><td>22</td><td>21</td><td>20</td><td></td><td></td><td></td></tr> <tr><td></td><td></td><td></td><td>15</td><td>14</td><td></td><td></td><td>10</td><td>9</td><td></td><td>6</td><td>5</td><td>4</td><td></td><td></td><td></td></tr> </table>	72	70		67	66		63	62		59	57					53	52	51			46	44	42	41	40	39					34	33			73		30		27	26	25		22	21	20							15	14			10	9		6	5	4																	
72	70		67	66		63	62		59	57					53																																																																						
52	51			46	44	42	41	40	39					34	33																																																																						
		73		30		27	26	25		22	21	20																																																																									
			15	14			10	9		6	5	4																																																																									
AVAILABLE	NOT APPLICABLE	34566-2623	G	0	A	BLACK	<table border="1"> <tr><td></td><td>71</td><td>69</td><td>68</td><td>67</td><td>65</td><td>64</td><td>63</td><td>61</td><td>59</td><td>57</td><td>56</td><td></td><td></td><td></td><td></td></tr> <tr><td></td><td></td><td>50</td><td>49</td><td>47</td><td></td><td></td><td></td><td>41</td><td></td><td>38</td><td>37</td><td>36</td><td></td><td>34</td><td>33</td></tr> <tr><td></td><td></td><td>73</td><td>32</td><td>31</td><td>30</td><td>29</td><td>28</td><td>27</td><td></td><td>24</td><td>23</td><td></td><td>20</td><td>19</td><td>18</td></tr> <tr><td></td><td></td><td></td><td>16</td><td></td><td></td><td>13</td><td>12</td><td>11</td><td>10</td><td>9</td><td>7</td><td></td><td>4</td><td></td><td></td></tr> </table>		71	69	68	67	65	64	63	61	59	57	56							50	49	47				41		38	37	36		34	33			73	32	31	30	29	28	27		24	23		20	19	18				16			13	12	11	10	9	7		4																
	71	69	68	67	65	64	63	61	59	57	56																																																																										
		50	49	47				41		38	37	36		34	33																																																																						
		73	32	31	30	29	28	27		24	23		20	19	18																																																																						
			16			13	12	11	10	9	7		4																																																																								
AVAILABLE	NOT APPLICABLE	34566-2633	G	0	A	BLACK	<table border="1"> <tr><td></td><td>71</td><td>69</td><td>68</td><td>67</td><td>65</td><td>64</td><td></td><td>61</td><td>59</td><td>57</td><td>56</td><td></td><td></td><td></td><td></td></tr> <tr><td></td><td></td><td>50</td><td>49</td><td>47</td><td></td><td></td><td></td><td>41</td><td></td><td>38</td><td>37</td><td>36</td><td></td><td>34</td><td>33</td></tr> <tr><td></td><td></td><td>73</td><td>32</td><td>31</td><td>30</td><td>29</td><td>28</td><td>27</td><td></td><td>24</td><td>23</td><td></td><td>20</td><td>19</td><td>18</td></tr> <tr><td></td><td></td><td></td><td>16</td><td></td><td></td><td></td><td>11</td><td>10</td><td>9</td><td>7</td><td></td><td></td><td>4</td><td></td><td></td></tr> </table>		71	69	68	67	65	64		61	59	57	56							50	49	47				41		38	37	36		34	33			73	32	31	30	29	28	27		24	23		20	19	18				16				11	10	9	7			4																
	71	69	68	67	65	64		61	59	57	56																																																																										
		50	49	47				41		38	37	36		34	33																																																																						
		73	32	31	30	29	28	27		24	23		20	19	18																																																																						
			16				11	10	9	7			4																																																																								
AVAILABLE	NOT APPLICABLE	34566-2643	G	0	A	BLACK	<table border="1"> <tr><td></td><td>71</td><td>69</td><td>68</td><td>67</td><td>65</td><td>64</td><td>63</td><td>61</td><td>59</td><td>57</td><td>56</td><td></td><td></td><td></td><td></td></tr> <tr><td></td><td></td><td>50</td><td>49</td><td>47</td><td></td><td></td><td></td><td>41</td><td>39</td><td>38</td><td>37</td><td>36</td><td></td><td>34</td><td>33</td></tr> <tr><td></td><td></td><td>73</td><td>32</td><td>31</td><td>30</td><td>29</td><td>28</td><td>27</td><td></td><td>24</td><td>23</td><td>22</td><td></td><td>20</td><td>19</td><td>18</td></tr> <tr><td></td><td></td><td></td><td>16</td><td></td><td></td><td>13</td><td>12</td><td>11</td><td>10</td><td>9</td><td>7</td><td></td><td>4</td><td></td><td></td></tr> </table>		71	69	68	67	65	64	63	61	59	57	56							50	49	47				41	39	38	37	36		34	33			73	32	31	30	29	28	27		24	23	22		20	19	18				16			13	12	11	10	9	7		4															
	71	69	68	67	65	64	63	61	59	57	56																																																																										
		50	49	47				41	39	38	37	36		34	33																																																																						
		73	32	31	30	29	28	27		24	23	22		20	19	18																																																																					
			16			13	12	11	10	9	7		4																																																																								
AVAILABLE	NOT APPLICABLE	34566-2653	G	0	A	BLACK	<table border="1"> <tr><td></td><td>71</td><td>69</td><td>68</td><td>67</td><td>65</td><td>64</td><td></td><td>61</td><td>59</td><td>57</td><td>56</td><td></td><td></td><td></td><td></td></tr> <tr><td></td><td></td><td>50</td><td>49</td><td>47</td><td></td><td></td><td></td><td>41</td><td>39</td><td>38</td><td>37</td><td>36</td><td></td><td>34</td><td>33</td></tr> <tr><td></td><td></td><td>73</td><td>32</td><td>31</td><td>30</td><td>29</td><td>28</td><td>27</td><td></td><td>24</td><td>23</td><td>22</td><td></td><td>20</td><td>19</td><td>18</td></tr> <tr><td></td><td></td><td></td><td>16</td><td></td><td></td><td></td><td>11</td><td>10</td><td>9</td><td>7</td><td></td><td></td><td>4</td><td></td><td></td></tr> </table>		71	69	68	67	65	64		61	59	57	56							50	49	47				41	39	38	37	36		34	33			73	32	31	30	29	28	27		24	23	22		20	19	18				16				11	10	9	7			4															
	71	69	68	67	65	64		61	59	57	56																																																																										
		50	49	47				41	39	38	37	36		34	33																																																																						
		73	32	31	30	29	28	27		24	23	22		20	19	18																																																																					
			16				11	10	9	7			4																																																																								
AVAILABLE	NOT APPLICABLE	34566-2663	G	0	H	ST GRAY	<table border="1"> <tr><td></td><td>79</td><td>78</td><td>77</td><td>76</td><td>75</td><td>74</td><td>73</td><td>72</td><td>71</td><td>70</td><td>69</td><td>68</td><td></td><td>66</td><td>65</td><td>64</td><td>63</td><td>61</td></tr> <tr><td>60</td><td>59</td><td>58</td><td>57</td><td>56</td><td></td><td></td><td>53</td><td>52</td><td></td><td>50</td><td></td><td></td><td></td><td></td><td></td><td>44</td><td>43</td><td>41</td></tr> <tr><td>40</td><td>39</td><td>38</td><td>37</td><td></td><td>35</td><td>34</td><td></td><td>32</td><td></td><td>30</td><td>29</td><td></td><td>27</td><td>26</td><td></td><td></td><td></td><td>22</td><td>21</td></tr> <tr><td>20</td><td>19</td><td>18</td><td>17</td><td></td><td></td><td></td><td>13</td><td>12</td><td></td><td></td><td></td><td>8</td><td></td><td>6</td><td>5</td><td></td><td>3</td><td>2</td><td></td></tr> </table>		79	78	77	76	75	74	73	72	71	70	69	68		66	65	64	63	61	60	59	58	57	56			53	52		50						44	43	41	40	39	38	37		35	34		32		30	29		27	26				22	21	20	19	18	17				13	12				8		6	5		3	2	
	79	78	77	76	75	74	73	72	71	70	69	68		66	65	64	63	61																																																																			
60	59	58	57	56			53	52		50						44	43	41																																																																			
40	39	38	37		35	34		32		30	29		27	26				22	21																																																																		
20	19	18	17				13	12				8		6	5		3	2																																																																			
AVAILABLE	NOT APPLICABLE	34566-2673	G	0	H	ST GRAY	<table border="1"> <tr><td></td><td>79</td><td>78</td><td>77</td><td>76</td><td>75</td><td>74</td><td>73</td><td>72</td><td>71</td><td>70</td><td>69</td><td>68</td><td></td><td>66</td><td>65</td><td>64</td><td>63</td><td>61</td></tr> <tr><td>60</td><td>59</td><td>58</td><td>57</td><td>56</td><td></td><td></td><td>53</td><td>52</td><td></td><td>50</td><td></td><td></td><td></td><td></td><td></td><td>44</td><td>43</td><td>41</td></tr> <tr><td>40</td><td>39</td><td>38</td><td>37</td><td></td><td>35</td><td>34</td><td></td><td>32</td><td></td><td>30</td><td>29</td><td></td><td>27</td><td>26</td><td></td><td></td><td></td><td>22</td><td>21</td></tr> <tr><td>20</td><td>19</td><td>18</td><td>17</td><td>16</td><td></td><td></td><td>13</td><td>12</td><td></td><td></td><td></td><td>8</td><td></td><td>6</td><td>5</td><td></td><td>3</td><td>2</td><td></td></tr> </table>		79	78	77	76	75	74	73	72	71	70	69	68		66	65	64	63	61	60	59	58	57	56			53	52		50						44	43	41	40	39	38	37		35	34		32		30	29		27	26				22	21	20	19	18	17	16			13	12				8		6	5		3	2	
	79	78	77	76	75	74	73	72	71	70	69	68		66	65	64	63	61																																																																			
60	59	58	57	56			53	52		50						44	43	41																																																																			
40	39	38	37		35	34		32		30	29		27	26				22	21																																																																		
20	19	18	17	16			13	12				8		6	5		3	2																																																																			

<b>ENTER DESCRIPTION</b> TEC NO. UAU2010-1551 DRAWN BY: CHYKORFF   HS CHECKED BY: APPR:VKOSHY DATE: 2010/03/18 DATE: 2008/05/09 DATE: 2010/03/18	QUALITY SYMBOLS	GENERAL TOLERANCES (UNLESS SPECIFIED)	DIMENSION STYLE	SCALE	DESIGN UNITS	THIRD ANGLE PROJECTION	
	=0 =0 ANGULAR ±---°	mm    INCH 4 PLACES ±--- ±--- 3 PLACES ±--- ±--- 2 PLACES ±--- ±--- 1 PLACE ±--- ±---	MM ONLY	1:1	METRIC	DRAWN BY: SRAJENDRANAT CHECKED BY: TSK IVER APPROVED BY: VKOSHY DATE: 2008/05/09 DATE: 2008/05/09 DATE: 2010/03/18	TITLE: MX123 73/80 CKT HRNS CONN ASSY
	DRAFT WHERE APPLICABLE MUST REMAIN WITHIN DIMENSIONS		SEE BOM TABLE	MOLEX INCORPORATED MATERIAL NO. NOT DOCUMENT NO. SD-34566-001		SHEET NO. 31 OF 36	
	THIS DRAWING CONTAINS INFORMATION THAT IS PROPRIETARY TO MOLEX INCORPORATED AND SHOULD NOT BE USED WITHOUT WRITTEN PERMISSION						



STATUS	GM PART #	MATERIAL #	PART/MATERIAL REVISION	WIRE DRESS OPTION	KEY OPTION	COLOR (TPA)	NUMBERS INDICATE CAVITIES OPEN FOR CIRCUITS																																																																																																														
AVAILABLE	NOT APPLICABLE	34566-2683	G	0	H	ST GRY	<table border="1"> <tr><td></td><td></td><td>78</td><td></td><td></td><td></td><td></td><td></td><td></td><td></td><td>72</td><td>71</td><td>70</td><td>69</td><td>68</td><td>67</td><td>66</td><td>65</td><td>64</td><td>63</td><td>61</td></tr> <tr><td>60</td><td>59</td><td>58</td><td>57</td><td>56</td><td></td><td></td><td></td><td></td><td></td><td>53</td><td>52</td><td>51</td><td>50</td><td>48</td><td>47</td><td></td><td></td><td></td><td>44</td><td>43</td><td>41</td></tr> <tr><td>40</td><td></td><td></td><td>37</td><td>35</td><td>34</td><td></td><td></td><td></td><td></td><td>32</td><td></td><td>30</td><td>29</td><td></td><td>27</td><td>26</td><td></td><td></td><td></td><td>22</td><td>21</td></tr> <tr><td>20</td><td>19</td><td>18</td><td>17</td><td>16</td><td></td><td></td><td></td><td></td><td></td><td>13</td><td>12</td><td></td><td></td><td></td><td>8</td><td>7</td><td>6</td><td>5</td><td>4</td><td>3</td><td>2</td><td>1</td></tr> </table>			78								72	71	70	69	68	67	66	65	64	63	61	60	59	58	57	56						53	52	51	50	48	47				44	43	41	40			37	35	34					32		30	29		27	26				22	21	20	19	18	17	16						13	12				8	7	6	5	4	3	2	1																						
		78								72	71	70	69	68	67	66	65	64	63	61																																																																																																	
60	59	58	57	56						53	52	51	50	48	47				44	43	41																																																																																																
40			37	35	34					32		30	29		27	26				22	21																																																																																																
20	19	18	17	16						13	12				8	7	6	5	4	3	2	1																																																																																															
AVAILABLE	NOT APPLICABLE	34566-2693	G	0	B	ST GRY	<table border="1"> <tr><td></td><td>71</td><td>70</td><td>68</td><td>66</td><td>65</td><td></td><td></td><td></td><td></td><td></td><td></td><td></td><td>60</td><td>59</td><td>58</td><td>57</td><td></td><td></td><td></td><td>54</td><td>53</td></tr> <tr><td></td><td>51</td><td>50</td><td>49</td><td>48</td><td>46</td><td>45</td><td>43</td><td>42</td><td>41</td><td>40</td><td>39</td><td>38</td><td>37</td><td>36</td><td>35</td><td></td><td></td><td></td><td></td><td></td><td>33</td></tr> <tr><td></td><td></td><td></td><td>73</td><td>32</td><td>31</td><td>30</td><td></td><td></td><td></td><td></td><td></td><td></td><td>24</td><td>23</td><td>22</td><td></td><td></td><td></td><td>20</td><td></td><td></td></tr> <tr><td></td><td></td><td></td><td></td><td>16</td><td>15</td><td>13</td><td>12</td><td>11</td><td>10</td><td>9</td><td>8</td><td>7</td><td>6</td><td>5</td><td>4</td><td></td><td></td><td></td><td></td><td></td><td></td></tr> </table>		71	70	68	66	65								60	59	58	57				54	53		51	50	49	48	46	45	43	42	41	40	39	38	37	36	35						33				73	32	31	30							24	23	22				20							16	15	13	12	11	10	9	8	7	6	5	4																												
	71	70	68	66	65								60	59	58	57				54	53																																																																																																
	51	50	49	48	46	45	43	42	41	40	39	38	37	36	35						33																																																																																																
			73	32	31	30							24	23	22				20																																																																																																		
				16	15	13	12	11	10	9	8	7	6	5	4																																																																																																						
AVAILABLE	NOT APPLICABLE	34566-2713	G	0	A	BLACK	<table border="1"> <tr><td></td><td></td><td></td><td>69</td><td>68</td><td></td><td></td><td>65</td><td>64</td><td>63</td><td></td><td></td><td>61</td><td>60</td><td>59</td><td>58</td><td></td><td>56</td><td></td><td></td><td></td><td></td></tr> <tr><td>52</td><td></td><td>50</td><td>49</td><td></td><td>47</td><td></td><td></td><td></td><td></td><td></td><td></td><td>41</td><td></td><td></td><td>38</td><td>37</td><td>36</td><td></td><td>34</td><td>33</td><td></td></tr> <tr><td></td><td></td><td></td><td></td><td></td><td>73</td><td>32</td><td>31</td><td>30</td><td>29</td><td>28</td><td>27</td><td>25</td><td>24</td><td>23</td><td></td><td></td><td></td><td>20</td><td>19</td><td>18</td><td>17</td></tr> <tr><td></td><td></td><td></td><td></td><td></td><td></td><td>16</td><td></td><td></td><td>13</td><td>12</td><td>11</td><td>10</td><td>9</td><td></td><td></td><td></td><td></td><td></td><td></td><td></td><td>1</td></tr> </table>				69	68			65	64	63			61	60	59	58		56					52		50	49		47							41			38	37	36		34	33							73	32	31	30	29	28	27	25	24	23				20	19	18	17							16			13	12	11	10	9								1																						
			69	68			65	64	63			61	60	59	58		56																																																																																																				
52		50	49		47							41			38	37	36		34	33																																																																																																	
					73	32	31	30	29	28	27	25	24	23				20	19	18	17																																																																																																
						16			13	12	11	10	9								1																																																																																																
AVAILABLE	NOT APPLICABLE	34566-2723	G	0	B	ST GRY	<table border="1"> <tr><td></td><td>71</td><td>70</td><td>68</td><td>66</td><td>65</td><td>64</td><td>63</td><td></td><td></td><td></td><td></td><td>60</td><td>59</td><td>58</td><td>57</td><td>56</td><td>55</td><td>54</td><td>53</td><td></td></tr> <tr><td></td><td>51</td><td>50</td><td>49</td><td>48</td><td>46</td><td>45</td><td>43</td><td>42</td><td>41</td><td>40</td><td>39</td><td>38</td><td>37</td><td>36</td><td>35</td><td></td><td></td><td></td><td></td><td>33</td></tr> <tr><td></td><td></td><td></td><td>73</td><td>32</td><td>31</td><td>30</td><td></td><td></td><td></td><td></td><td></td><td>24</td><td>23</td><td>22</td><td></td><td>20</td><td>19</td><td></td><td></td><td></td></tr> <tr><td></td><td></td><td></td><td></td><td>16</td><td>15</td><td>13</td><td>12</td><td>11</td><td>10</td><td>9</td><td>8</td><td>7</td><td>6</td><td>5</td><td>4</td><td>3</td><td>2</td><td></td><td></td><td></td></tr> </table>		71	70	68	66	65	64	63					60	59	58	57	56	55	54	53			51	50	49	48	46	45	43	42	41	40	39	38	37	36	35					33				73	32	31	30						24	23	22		20	19								16	15	13	12	11	10	9	8	7	6	5	4	3	2																													
	71	70	68	66	65	64	63					60	59	58	57	56	55	54	53																																																																																																		
	51	50	49	48	46	45	43	42	41	40	39	38	37	36	35					33																																																																																																	
			73	32	31	30						24	23	22		20	19																																																																																																				
				16	15	13	12	11	10	9	8	7	6	5	4	3	2																																																																																																				
AVAILABLE	NOT APPLICABLE	34566-2733	G	0	A	BLACK	<table border="1"> <tr><td></td><td></td><td>70</td><td>68</td><td>67</td><td>66</td><td>65</td><td></td><td></td><td></td><td></td><td></td><td></td><td></td><td>58</td><td>57</td><td></td><td>55</td><td></td><td></td><td></td><td></td></tr> <tr><td></td><td></td><td></td><td>49</td><td>47</td><td></td><td></td><td>44</td><td>43</td><td>42</td><td>41</td><td></td><td></td><td>39</td><td>37</td><td></td><td></td><td></td><td></td><td></td><td></td><td></td></tr> <tr><td></td><td></td><td></td><td></td><td>73</td><td>32</td><td>30</td><td></td><td></td><td>27</td><td>25</td><td>24</td><td>23</td><td></td><td>21</td><td>20</td><td>19</td><td>18</td><td>17</td><td></td><td></td><td></td></tr> <tr><td></td><td></td><td></td><td></td><td></td><td>16</td><td>15</td><td>13</td><td></td><td>10</td><td>9</td><td>8</td><td>7</td><td>6</td><td>5</td><td></td><td>3</td><td>2</td><td>1</td><td></td><td></td><td></td></tr> </table>			70	68	67	66	65								58	57		55								49	47			44	43	42	41			39	37												73	32	30			27	25	24	23		21	20	19	18	17									16	15	13		10	9	8	7	6	5		3	2	1																									
		70	68	67	66	65								58	57		55																																																																																																				
			49	47			44	43	42	41			39	37																																																																																																							
				73	32	30			27	25	24	23		21	20	19	18	17																																																																																																			
					16	15	13		10	9	8	7	6	5		3	2	1																																																																																																			
AVAILABLE	NOT APPLICABLE	34566-2743	G	0	C	BLUE	<table border="1"> <tr><td>72</td><td>70</td><td></td><td></td><td>67</td><td>66</td><td></td><td></td><td>63</td><td>62</td><td></td><td></td><td>59</td><td>57</td><td></td><td></td><td></td><td></td><td></td><td></td><td>53</td></tr> <tr><td>52</td><td>51</td><td></td><td></td><td></td><td>46</td><td>44</td><td></td><td>42</td><td></td><td></td><td>40</td><td>39</td><td></td><td></td><td></td><td></td><td></td><td></td><td></td><td>34</td><td>33</td></tr> <tr><td></td><td></td><td></td><td></td><td></td><td>73</td><td>32</td><td>30</td><td></td><td></td><td></td><td>26</td><td>25</td><td></td><td></td><td>22</td><td>21</td><td>20</td><td></td><td></td><td></td></tr> <tr><td></td><td></td><td></td><td></td><td></td><td></td><td>15</td><td>14</td><td></td><td></td><td></td><td>10</td><td>9</td><td></td><td></td><td>6</td><td>5</td><td>4</td><td></td><td></td><td></td></tr> </table>	72	70			67	66			63	62			59	57							53	52	51				46	44		42			40	39								34	33						73	32	30				26	25			22	21	20										15	14				10	9			6	5	4																												
72	70			67	66			63	62			59	57							53																																																																																																	
52	51				46	44		42			40	39								34	33																																																																																																
					73	32	30				26	25			22	21	20																																																																																																				
						15	14				10	9			6	5	4																																																																																																				
AVAILABLE	NOT APPLICABLE	34566-2753	G	0	A	BLACK	<table border="1"> <tr><td></td><td></td><td></td><td></td><td></td><td></td><td></td><td></td><td>63</td><td>62</td><td>61</td><td></td><td></td><td></td><td>58</td><td>57</td><td>56</td><td>55</td><td>54</td><td>53</td><td></td></tr> <tr><td>52</td><td>51</td><td></td><td>49</td><td></td><td></td><td></td><td></td><td>44</td><td>43</td><td>42</td><td>41</td><td></td><td></td><td></td><td>37</td><td>36</td><td>35</td><td>34</td><td>33</td><td></td></tr> <tr><td></td><td></td><td></td><td></td><td></td><td></td><td></td><td></td><td>73</td><td>32</td><td>29</td><td>28</td><td>27</td><td>26</td><td></td><td></td><td></td><td>19</td><td>18</td><td></td><td></td></tr> <tr><td></td><td></td><td></td><td></td><td></td><td></td><td></td><td></td><td></td><td>16</td><td>15</td><td>13</td><td>12</td><td>11</td><td>10</td><td></td><td></td><td></td><td></td><td></td><td>3</td></tr> </table>									63	62	61				58	57	56	55	54	53		52	51		49					44	43	42	41				37	36	35	34	33										73	32	29	28	27	26				19	18												16	15	13	12	11	10						3																										
								63	62	61				58	57	56	55	54	53																																																																																																		
52	51		49					44	43	42	41				37	36	35	34	33																																																																																																		
								73	32	29	28	27	26				19	18																																																																																																			
									16	15	13	12	11	10						3																																																																																																	
AVAILABLE	NOT APPLICABLE	34566-2763	G	0	B	ST GRY	<table border="1"> <tr><td>72</td><td>71</td><td>70</td><td>68</td><td>67</td><td>66</td><td></td><td></td><td></td><td></td><td>62</td><td>61</td><td>60</td><td>59</td><td>58</td><td>57</td><td>56</td><td>55</td><td>54</td><td>53</td><td></td></tr> <tr><td>52</td><td>51</td><td>50</td><td>48</td><td>47</td><td>46</td><td></td><td></td><td></td><td></td><td>42</td><td>41</td><td>40</td><td>39</td><td>38</td><td>37</td><td>36</td><td>35</td><td>34</td><td>33</td><td></td></tr> <tr><td></td><td></td><td></td><td>73</td><td>32</td><td>31</td><td>30</td><td>29</td><td>28</td><td>27</td><td>26</td><td>25</td><td>24</td><td></td><td></td><td></td><td></td><td></td><td></td><td></td><td></td></tr> <tr><td></td><td></td><td></td><td></td><td>16</td><td>15</td><td>14</td><td>13</td><td></td><td></td><td>10</td><td>9</td><td>8</td><td></td><td></td><td></td><td></td><td></td><td></td><td></td><td></td></tr> </table>	72	71	70	68	67	66					62	61	60	59	58	57	56	55	54	53		52	51	50	48	47	46					42	41	40	39	38	37	36	35	34	33					73	32	31	30	29	28	27	26	25	24													16	15	14	13			10	9	8																																		
72	71	70	68	67	66					62	61	60	59	58	57	56	55	54	53																																																																																																		
52	51	50	48	47	46					42	41	40	39	38	37	36	35	34	33																																																																																																		
			73	32	31	30	29	28	27	26	25	24																																																																																																									
				16	15	14	13			10	9	8																																																																																																									
AVAILABLE	NOT APPLICABLE	34566-2773	G	0	H	ST GRY	<table border="1"> <tr><td></td><td></td><td></td><td></td><td></td><td></td><td></td><td></td><td></td><td></td><td></td><td></td><td></td><td></td><td></td><td></td><td></td><td></td><td></td><td></td><td></td><td>61</td></tr> <tr><td></td><td></td><td></td><td></td><td></td><td></td><td></td><td></td><td></td><td></td><td></td><td></td><td></td><td></td><td></td><td></td><td></td><td></td><td></td><td></td><td></td><td>53</td></tr> <tr><td></td><td></td><td></td><td></td><td></td><td></td><td></td><td></td><td></td><td></td><td></td><td></td><td></td><td></td><td></td><td></td><td></td><td></td><td></td><td></td><td></td><td>32</td></tr> <tr><td>20</td><td></td><td></td><td></td><td></td><td></td><td></td><td></td><td></td><td></td><td></td><td></td><td></td><td>9</td><td></td><td></td><td></td><td></td><td></td><td></td><td></td><td>5</td></tr> <tr><td></td><td></td><td></td><td></td><td></td><td></td><td></td><td></td><td></td><td></td><td></td><td></td><td></td><td></td><td></td><td></td><td></td><td></td><td></td><td></td><td></td><td>1</td></tr> </table>																						61																						53																						32	20													9								5																						1
																					61																																																																																																
																					53																																																																																																
																					32																																																																																																
20													9								5																																																																																																
																					1																																																																																																
AVAILABLE	NOT APPLICABLE	34566-2783	G	9	H	ST GRY	<table border="1"> <tr><td></td><td></td><td></td><td></td><td></td><td></td><td></td><td></td><td></td><td></td><td></td><td></td><td></td><td></td><td></td><td></td><td></td><td></td><td></td><td></td><td></td><td>61</td></tr> <tr><td></td><td></td><td></td><td></td><td></td><td></td><td></td><td></td><td></td><td></td><td></td><td></td><td></td><td></td><td></td><td></td><td></td><td></td><td></td><td></td><td></td><td>53</td></tr> <tr><td></td><td></td><td></td><td></td><td></td><td></td><td></td><td></td><td></td><td></td><td></td><td></td><td></td><td></td><td></td><td></td><td></td><td></td><td></td><td></td><td></td><td>32</td></tr> <tr><td>20</td><td></td><td></td><td></td><td></td><td></td><td></td><td></td><td></td><td></td><td></td><td></td><td></td><td>9</td><td></td><td></td><td></td><td></td><td></td><td></td><td></td><td>5</td></tr> <tr><td></td><td></td><td></td><td></td><td></td><td></td><td></td><td></td><td></td><td></td><td></td><td></td><td></td><td></td><td></td><td></td><td></td><td></td><td></td><td></td><td></td><td>1</td></tr> </table>																						61																						53																						32	20													9								5																						1
																					61																																																																																																
																					53																																																																																																
																					32																																																																																																
20													9								5																																																																																																
																					1																																																																																																

<b>ENTER DESCRIPTION</b> EC NO. UAU2010-1551 DRAWN BY 2010/03/15 CHKD BY FFJHS 2008/05/09 APPR: VKOSHY 2010/03/18	QUALITY SYMBOLS	GENERAL TOLERANCES (UNLESS SPECIFIED)	DIMENSION STYLE	SCALE	DESIGN UNITS	THIRD ANGLE PROJECTION	
	=0 =0	mm INCH 4 PLACES # --- # --- 3 PLACES # --- # --- 2 PLACES # --- # --- 1 PLACE # --- # ---	MM ONLY	1:1	METRIC	DRAWN BY DATE SRAJENDRANAT 2008/05/09 CHECKED BY DATE TSK IVER 2008/05/09 APPROVED BY DATE VKOSHY 2010/03/18	TITLE MX123 73/80 CKT HRNS CONN ASSY
	DRAFT WHERE APPLICABLE MUST REMAIN WITHIN DIMENSIONS	SEE BOM TABLE	MATERIAL NO. MOLEX INCORPORATED	DOCUMENT NO. SD-34566-001	SHEET NO. 32 OF 36	THIS DRAWING CONTAINS INFORMATION THAT IS PROPRIETARY TO MOLEX INCORPORATED AND SHOULD NOT BE USED WITHOUT WRITTEN PERMISSION	
	SIZE D						



STATUS	GM PART #	MATERIAL #	PART/MATERIAL REVISION	WIRE DRESS OPTION	KEY OPTION	COLOR (TPA)	NUMBERS INDICATE CAVITIES OPEN FOR CIRCUITS																
AVAILABLE	NOT APPLICABLE	34566-2893	G	0	A	BLACK	72		69	67	65	63		60		57	56		53				
									49	47	46	44	43		40		37	36	35	33			
							73			31	30	29	28		24		21	20		17			
									16	15	14	13		11	10			5	4	3	2	1	
AVAILABLE	NOT APPLICABLE	34566-2913	G	0	B	ST GRAY				68	67		64						58				
											46	45							38				
							73			32		30	29	28	27				22				17
										15	13			10									1
AVAILABLE	NOT APPLICABLE	34566-2923	G	0	B	ST GRAY				68	67		64										
											46	45											
							73			32		30	29	28	27								17
										15	13			10									
AVAILABLE	NOT APPLICABLE	34566-2933	G	0	A	BLACK	72		69	67	65	63		60		57	56		53				
									49	47		44	43		40		37	36	35	33			
							73			31	30	29	28		24		21	20		17			
									16	15	14			11	10				5	4	3	2	1
AVAILABLE	NOT APPLICABLE	34566-2943	G	0	B	ST GRAY				68	67		64	63		59	57						
											46	45	43			39	37						
										32		30	29	28	27				21				
														10				6	5	4	3		
AVAILABLE	NOT APPLICABLE	34566-2953	G	0	B	ST GRAY				68	67		64	63		59							34
											46	45	43			39							
										32		30	29	28	27								
														10				6	5	4	3		
AVAILABLE	NOT APPLICABLE	34566-2963	G	0	H	ST GRAY		79			74	73	72	71	69	68	67		64	62	61		
								59			54	53	52		49	48	47			42	41		
									38			33			29	27		25				21	
											15	14		11	10	9	8	7					
AVAILABLE	NOT APPLICABLE	34566-2973	G	0	G	BLUE	80	78	77	76	75	74	73	72	70	69	67	65	64	63	62		
							60	58	57	56	55	54	52	51	50	49	47	45					
							40	38	37				33	32	31			27	26	25	24		
							20	18	17						10	9	8	6	5	4	3	2	1

<b>ENTER DESCRIPTION</b> TEC NO: JAU2010-1551 DRAWN BY: 2010/03/15 CHKD:DRFF/HS 2008/05/09 APPR:VKOSHY 2010/03/18	QUALITY SYMBOLS	GENERAL TOLERANCES (UNLESS SPECIFIED)	DIMENSION STYLE	SCALE	DESIGN UNITS	THIRD ANGLE PROJECTION
	▽=0	mm INCH	MM ONLY	2:1	METRIC	
	▽=0	4 PLACES ± --- ± ---	DRAWN BY DATE	TITLE		
	▽=0	3 PLACES ± --- ± ---	SRAJENDRANAT 2008/05/09	MX123		
	2 PLACES ± --- ± ---	CHECKED BY DATE	73/80 CKT			
	1 PLACE ± --- ± ---	TSK IVER 2008/05/09	HRNS CONN ASSY			
	ANGULAR ± ---°	APPROVED BY DATE	MOLEX INCORPORATED			
		VKOSHY 2010/03/18	SD-34566-001			
	DRAFT WHERE APPLICABLE MUST REMAIN WITHIN DIMENSIONS	MATERIAL NO.	SHEET NO.			
		SEE BOM TABLE	34 OF 36			
		SIZE D	THIS DRAWING CONTAINS INFORMATION THAT IS PROPRIETARY TO MOLEX INCORPORATED AND SHOULD NOT BE USED WITHOUT WRITTEN PERMISSION			

STATUS	GM PART #	MATERIAL #	PART/MATERIAL REVISION	WIRE DRESS OPTION	KEY OPTION	COLOR (TPA)	NUMBERS INDICATE CAVITIES OPEN FOR CIRCUITS																																																																																																																														
AVAILABLE	NOT APPLICABLE	34566-9913	G	0	A	BLACK	<table border="1"> <tr><td>72</td><td>71</td><td></td><td></td><td>68</td><td>67</td><td>66</td><td>65</td><td>64</td><td></td><td></td><td></td><td></td><td></td><td></td><td>59</td><td></td><td></td><td></td><td></td><td></td></tr> <tr><td></td><td></td><td>50</td><td></td><td>48</td><td>47</td><td>46</td><td>45</td><td></td><td></td><td></td><td></td><td></td><td></td><td></td><td>40</td><td>39</td><td>38</td><td></td><td></td><td></td></tr> <tr><td></td><td></td><td></td><td></td><td>31</td><td>30</td><td></td><td></td><td></td><td></td><td></td><td></td><td></td><td></td><td>25</td><td>24</td><td></td><td>22</td><td>21</td><td>20</td><td></td></tr> <tr><td></td><td></td><td></td><td></td><td></td><td></td><td>14</td><td></td><td></td><td></td><td></td><td></td><td></td><td></td><td></td><td>9</td><td>7</td><td>6</td><td>5</td><td>4</td><td></td></tr> <tr><td></td><td></td><td></td><td></td><td></td><td></td><td></td><td></td><td></td><td></td><td></td><td></td><td></td><td></td><td></td><td></td><td></td><td></td><td></td><td>2</td><td>1</td></tr> </table>	72	71			68	67	66	65	64							59								50		48	47	46	45								40	39	38								31	30									25	24		22	21	20								14									9	7	6	5	4																					2	1																					
72	71			68	67	66	65	64							59																																																																																																																						
		50		48	47	46	45								40	39	38																																																																																																																				
				31	30									25	24		22	21	20																																																																																																																		
						14									9	7	6	5	4																																																																																																																		
																			2	1																																																																																																																	
AVAILABLE	NOT APPLICABLE	34566-9923	G	0	A	BLACK	<table border="1"> <tr><td>72</td><td>71</td><td></td><td></td><td></td><td>67</td><td>66</td><td></td><td></td><td></td><td>62</td><td>61</td><td>60</td><td></td><td></td><td>57</td><td></td><td></td><td>55</td><td>54</td></tr> <tr><td></td><td>51</td><td></td><td></td><td></td><td>48</td><td>46</td><td>45</td><td>44</td><td>43</td><td>42</td><td></td><td></td><td></td><td></td><td>39</td><td></td><td></td><td></td><td>35</td><td>33</td></tr> <tr><td></td><td></td><td></td><td></td><td></td><td></td><td>15</td><td>14</td><td></td><td></td><td></td><td></td><td></td><td></td><td></td><td>8</td><td>7</td><td>6</td><td>5</td><td>4</td><td></td></tr> <tr><td></td><td></td><td></td><td></td><td></td><td></td><td></td><td></td><td></td><td></td><td></td><td></td><td></td><td></td><td></td><td></td><td></td><td></td><td></td><td>3</td><td>2</td></tr> </table>	72	71				67	66				62	61	60			57			55	54		51				48	46	45	44	43	42					39				35	33							15	14								8	7	6	5	4																					3	2																																											
72	71				67	66				62	61	60			57			55	54																																																																																																																		
	51				48	46	45	44	43	42					39				35	33																																																																																																																	
						15	14								8	7	6	5	4																																																																																																																		
																			3	2																																																																																																																	
AVAILABLE	NOT APPLICABLE	34566-9933	G	0	B	ST GRAY	<table border="1"> <tr><td></td><td></td><td></td><td>69</td><td></td><td></td><td>65</td><td>64</td><td>63</td><td></td><td></td><td></td><td></td><td></td><td></td><td></td><td></td><td></td><td></td><td></td><td></td></tr> <tr><td></td><td></td><td></td><td>49</td><td></td><td></td><td>45</td><td>44</td><td>43</td><td></td><td></td><td></td><td></td><td></td><td></td><td></td><td></td><td></td><td></td><td></td><td></td></tr> <tr><td></td><td></td><td></td><td></td><td></td><td></td><td></td><td></td><td></td><td></td><td></td><td></td><td></td><td></td><td></td><td></td><td></td><td></td><td>22</td><td>21</td><td>20</td></tr> <tr><td></td><td></td><td></td><td></td><td></td><td></td><td></td><td></td><td></td><td></td><td></td><td></td><td></td><td></td><td></td><td></td><td></td><td></td><td>6</td><td>5</td><td>4</td></tr> <tr><td></td><td></td><td></td><td></td><td></td><td></td><td></td><td></td><td></td><td></td><td></td><td></td><td></td><td></td><td></td><td></td><td></td><td></td><td></td><td>3</td><td>2</td></tr> <tr><td></td><td></td><td></td><td></td><td></td><td></td><td></td><td></td><td></td><td></td><td></td><td></td><td></td><td></td><td></td><td></td><td></td><td></td><td></td><td></td><td>1</td></tr> </table>				69			65	64	63																49			45	44	43																															22	21	20																			6	5	4																				3	2																					1
			69			65	64	63																																																																																																																													
			49			45	44	43																																																																																																																													
																		22	21	20																																																																																																																	
																		6	5	4																																																																																																																	
																			3	2																																																																																																																	
																				1																																																																																																																	
AVAILABLE	NOT APPLICABLE	34566-9943	G	0	C	BLUE	<table border="1"> <tr><td></td><td>71</td><td></td><td>69</td><td></td><td></td><td>65</td><td>64</td><td></td><td></td><td>61</td><td>60</td><td></td><td></td><td>58</td><td></td><td></td><td>56</td><td>55</td><td>54</td></tr> <tr><td></td><td></td><td>50</td><td>49</td><td></td><td></td><td>45</td><td>43</td><td>41</td><td></td><td></td><td></td><td></td><td></td><td></td><td></td><td>37</td><td>36</td><td>35</td><td></td></tr> <tr><td></td><td></td><td></td><td></td><td></td><td>31</td><td>29</td><td>28</td><td></td><td></td><td>24</td><td>23</td><td></td><td></td><td></td><td></td><td></td><td></td><td>19</td><td>18</td></tr> <tr><td></td><td></td><td></td><td></td><td></td><td>16</td><td></td><td>13</td><td>12</td><td>11</td><td></td><td>8</td><td>7</td><td></td><td></td><td></td><td></td><td></td><td>3</td><td>2</td></tr> <tr><td></td><td></td><td></td><td></td><td></td><td></td><td></td><td></td><td></td><td></td><td></td><td></td><td></td><td></td><td></td><td></td><td></td><td></td><td></td><td>1</td></tr> </table>		71		69			65	64			61	60			58			56	55	54			50	49			45	43	41								37	36	35							31	29	28			24	23							19	18						16		13	12	11		8	7						3	2																				1																										
	71		69			65	64			61	60			58			56	55	54																																																																																																																		
		50	49			45	43	41								37	36	35																																																																																																																			
					31	29	28			24	23							19	18																																																																																																																		
					16		13	12	11		8	7						3	2																																																																																																																		
																			1																																																																																																																		
AVAILABLE	NOT APPLICABLE	34566-9953	G	0	A	BLACK	<table border="1"> <tr><td></td><td></td><td></td><td></td><td></td><td>67</td><td></td><td></td><td></td><td>62</td><td></td><td>60</td><td></td><td></td><td>57</td><td></td><td></td><td>55</td><td></td><td></td></tr> <tr><td></td><td></td><td></td><td></td><td></td><td>51</td><td></td><td>48</td><td>46</td><td>45</td><td>44</td><td>43</td><td></td><td></td><td></td><td>39</td><td></td><td></td><td>35</td><td></td></tr> <tr><td></td><td></td><td></td><td></td><td></td><td></td><td></td><td></td><td></td><td></td><td></td><td></td><td>25</td><td></td><td></td><td></td><td></td><td></td><td></td><td></td></tr> <tr><td></td><td></td><td></td><td></td><td></td><td></td><td></td><td></td><td></td><td></td><td></td><td></td><td></td><td></td><td>7</td><td>6</td><td>5</td><td>4</td><td>3</td><td>2</td></tr> </table>						67				62		60			57			55								51		48	46	45	44	43				39			35														25																						7	6	5	4	3	2																																														
					67				62		60			57			55																																																																																																																				
					51		48	46	45	44	43				39			35																																																																																																																			
												25																																																																																																																									
														7	6	5	4	3	2																																																																																																																		
AVAILABLE	NOT APPLICABLE	34566-9963	G	0	B	ST GRAY	<table border="1"> <tr><td></td><td></td><td></td><td></td><td>68</td><td>67</td><td></td><td></td><td>64</td><td>63</td><td></td><td></td><td></td><td></td><td>58</td><td></td><td></td><td>55</td><td></td><td></td></tr> <tr><td></td><td></td><td></td><td></td><td></td><td></td><td></td><td>46</td><td>45</td><td>43</td><td></td><td></td><td></td><td></td><td>38</td><td></td><td></td><td>35</td><td></td><td></td></tr> <tr><td></td><td></td><td></td><td>73</td><td></td><td>32</td><td></td><td>30</td><td>29</td><td>28</td><td>27</td><td></td><td></td><td></td><td></td><td>22</td><td></td><td>19</td><td>17</td><td></td></tr> <tr><td></td><td></td><td></td><td></td><td></td><td>15</td><td></td><td>13</td><td></td><td></td><td>10</td><td></td><td></td><td></td><td></td><td></td><td></td><td></td><td></td><td>1</td></tr> </table>					68	67			64	63					58			55										46	45	43					38			35						73		32		30	29	28	27					22		19	17							15		13			10									1																																														
				68	67			64	63					58			55																																																																																																																				
							46	45	43					38			35																																																																																																																				
			73		32		30	29	28	27					22		19	17																																																																																																																			
					15		13			10									1																																																																																																																		
AVAILABLE	NOT APPLICABLE	34566-9973	G	0	B	ST GRAY	<table border="1"> <tr><td></td><td></td><td></td><td></td><td>68</td><td>67</td><td></td><td></td><td>64</td><td>63</td><td></td><td></td><td></td><td></td><td>58</td><td></td><td></td><td></td><td></td><td></td></tr> <tr><td></td><td></td><td></td><td></td><td></td><td></td><td></td><td>46</td><td>45</td><td>43</td><td></td><td></td><td></td><td></td><td>38</td><td></td><td></td><td></td><td></td><td></td></tr> <tr><td></td><td></td><td></td><td></td><td>32</td><td></td><td></td><td>30</td><td>29</td><td>28</td><td>27</td><td></td><td></td><td></td><td></td><td>22</td><td></td><td></td><td></td><td>17</td></tr> <tr><td></td><td></td><td></td><td></td><td></td><td>15</td><td></td><td>13</td><td></td><td></td><td>10</td><td></td><td></td><td></td><td></td><td></td><td></td><td></td><td></td><td></td></tr> </table>					68	67			64	63					58													46	45	43					38										32			30	29	28	27					22				17						15		13			10																																																							
				68	67			64	63					58																																																																																																																							
							46	45	43					38																																																																																																																							
				32			30	29	28	27					22				17																																																																																																																		
					15		13			10																																																																																																																											

<b>ENTER DESCRIPTION</b> TEC NO: JAU2010-1551 DRAWN BY: 2010/03/15 CHKD:DRFF   HS 2008/05/09 APPR:VKOSHY 2010/03/18	QUALITY SYMBOLS ▽=0 ▽=0 ▽=0	GENERAL TOLERANCES (UNLESS SPECIFIED) mm INCH 4 PLACES ± --- ± --- 3 PLACES ± --- ± --- 2 PLACES ± --- ± --- 1 PLACE ± --- ± --- ANGULAR ± ---°	DIMENSION STYLE <b>MM ONLY</b>	SCALE <b>1:1</b>	DESIGN UNITS <b>METRIC</b>	THIRD ANGLE PROJECTION 
	DRAWN BY: SRAJENDRANAT 2008/05/09 CHECKED BY: TSK IVER 2008/05/09 APPROVED BY: VKOSHY 2010/03/18		TITLE <b>MX123 73/80 CKT HRNS CONN ASSY</b>			
	MATERIAL NO: <b>SEE BOM TABLE</b>		DOCUMENT NO: <b>SD-34566-001</b>			
	DRAFT WHERE APPLICABLE MUST REMAIN WITHIN DIMENSIONS		SHEET NO: <b>35 OF 36</b>			

