

### Low Noise, Low Power, I<sup>2</sup>C<sup>®</sup> Bus, 256 Taps

The ISL22313 integrates a single digitally controlled potentiometer (DCP), control logic and non-volatile memory on a monolithic CMOS integrated circuit.

The digitally controlled potentiometer is implemented with a combination of resistor elements and CMOS switches. The position of the wipers are controlled by the user through the I<sup>2</sup>C bus interface. The potentiometer has an associated volatile Wiper Register (WR) and a non-volatile Initial Value Register (IVR) that can be directly written to and read by the user. The contents of the WR control the position of the wiper. At power up the device recalls the contents of the DCP's IVR to the WR.

The ISL22313 also has 14 general purpose non-volatile registers that can be used as storage of lookup table for multiple wiper position or any other valuable information.

The ISL22313 features a dual supply, that is beneficial for applications requiring a bipolar range for DCP terminals between V- and VCC.

The DCP can be used as a three-terminal potentiometer or as a two-terminal variable resistor in a wide variety of applications including control, parameter adjustments, and signal processing.

### Pinout

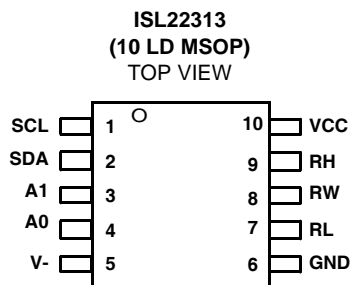

### Features

- 256 resistor taps
- I<sup>2</sup>C serial interface
  - Two address pins, up to four devices per bus
- Non-volatile EEPROM storage of wiper position
- 14 General Purpose non-volatile registers
- High reliability
  - Endurance: 1,000,000 data changes per bit per register
  - Register data retention: 50 years @ T<sub>s</sub> ≤ +55°C
- Wiper resistance: 70Ω typical @ 1mA
- Standby current <2.5μA max
- Shutdown current <2.5μA max
- Dual power supply
  - VCC = 2.25V to 5.5V
  - V- = -2.25V to -5.5V
- DCP terminal voltage from V- to VCC
- 10kΩ, 50kΩ or 100kΩ total resistance
- Extended industrial temperature range: -40 to +125°C
- 10 Lead MSOP
- Pb-free plus anneal product (RoHS compliant)

### Ordering Information

| PART NUMBER<br>(Notes 1, 2) | PART MARKING | RESISTANCE OPTION<br>(kΩ) | TEMP. RANGE<br>(°C) | PACKAGE<br>(Pb-Free) | PKG. DWG. # |
|-----------------------------|--------------|---------------------------|---------------------|----------------------|-------------|
| ISL22313TFU10Z              | 313TZ        | 100                       | -40 to +125         | 10 Ld MSOP           | M10.118     |
| ISL22313UFU10Z              | 313UZ        | 50                        | -40 to +125         | 10 Ld MSOP           | M10.118     |
| ISL22313WFU10Z              | 313WZ        | 10                        | -40 to +125         | 10 Ld MSOP           | M10.118     |

#### NOTES:

1. Intersil Pb-free plus anneal products employ special Pb-free material sets; molding compounds/die attach materials and 100% matte tin plate termination finish, which are RoHS compliant and compatible with both SnPb and Pb-free soldering operations. Intersil Pb-free products are MSL classified at Pb-free peak reflow temperatures that meet or exceed the Pb-free requirements of IPC/JEDEC J STD-020.
2. Add "-TK" suffix for 1,000 Tape and Reel option

**Block Diagram**

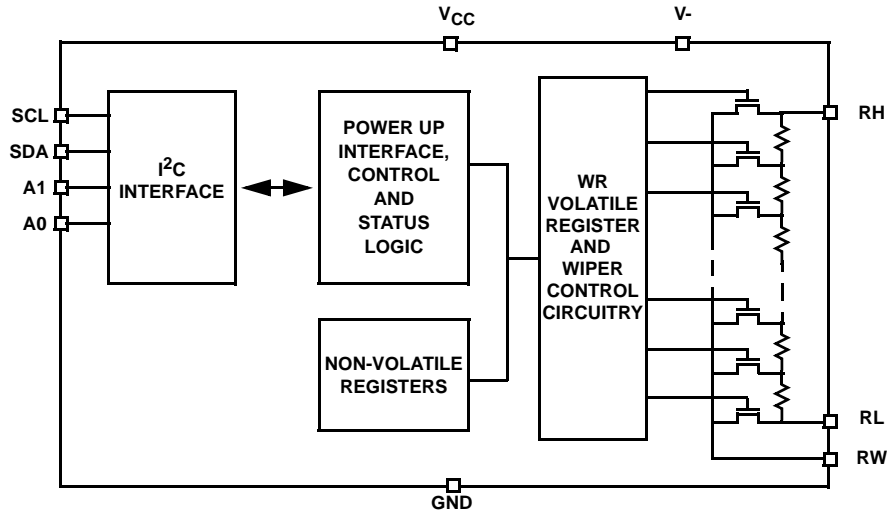

**Pin Descriptions**

| MSOP PIN | SYMBOL | DESCRIPTION   |
|----------|--------|---|
| 1        | SCL    | Open drain I <sup>2</sup> C interface clock input             |
| 2        | SDA    | Open drain Serial data I/O for the I <sup>2</sup> C interface |
| 3        | A1     | Device address input for the I <sup>2</sup> C interface       |
| 4        | A0     | Device address input for the I <sup>2</sup> C interface       |
| 5        | V-     | Negative supply pin   |
| 6        | GND    | Device ground pin   |
| 7        | RL     | "Low" terminal of DCP   |
| 8        | RW     | "Wiper" terminal of DCP                                       |
| 9        | RH     | "High" terminal of DCP  |
| 10       | VCC    | Power supply pin  |

**Absolute Maximum Ratings**

|  |                               |
|--|-------------------------------|
| Storage Temperature                                      | -65°C to +150°C               |
| Voltage at any Digital Interface Pin with Respect to GND | -0.3V to V <sub>CC</sub> +0.3 |
| V <sub>CC</sub>  | -0.3V to +6V                  |
| V-   | -6V to 0.3V                   |
| Voltage at any DCP Pin with respect to GND               | V- to V <sub>CC</sub>         |
| I <sub>W</sub> (10s)                                     | ±6mA                          |
| Latchup  | Class II, Level A at +125°C   |
| ESD  |                               |
| Human Body Model   | .3kV                          |
| Machine Model  | .400V                         |

**Thermal Information**

|  |   |
|--|---|
| Thermal Resistance (Typical, Note 3)           | θ <sub>JA</sub> (°C/W)  |
| 10 Lead MSOP                                   | 120   |
| Maximum Junction Temperature (Plastic Package) | +150°C  |
| Pb-free reflow profile                         | see link below  |
|  | <a href="http://www.intersil.com/pbfree/Pb-FreeReflow.asp">http://www.intersil.com/pbfree/Pb-FreeReflow.asp</a> |

**Recommended Operating Conditions**

|                                     |                 |
|-------------------------------------|-----------------|
| Temperature Range (Full Industrial) | -40°C to +125°C |
| Power Rating                        | 15mW            |
| V <sub>CC</sub>                     | 2.25V to 5.5V   |
| V-                                  | -2.25V to -5.5V |
| Max Wiper Current I <sub>w</sub>    | ±3.0mA          |

*CAUTION: Do not operate at or near the maximum ratings listed for extended periods of time. Exposure to such conditions may adversely impact product reliability and result in failures not covered by warranty.*

**NOTE:**

- 3. θ<sub>JA</sub> is measured with the component mounted on a high effective thermal conductivity test board in free air. See Tech Brief TB379 for details.

**Analog Specifications**

Over recommended operating conditions unless otherwise stated. Limits are established by characterization.

| SYMBOL  | PARAMETER                           | TEST CONDITIONS  | MIN (Note 18) | TYP (Note 4) | MAX (Note 18)   | UNIT         |
|---|-------------------------------------|--|---------------|--------------|-----------------|--------------|
| R <sub>TOTAL</sub>  | RH to RL resistance                 | W option   |               | 10           |                 | kΩ           |
|   |                                     | U option   |               | 50           |                 | kΩ           |
|   |                                     | T option   |               | 100          |                 | kΩ           |
|   | RH to RL resistance tolerance       |  | -20           |              | +20             | %            |
|   | End-to-End Temperature Coefficient  | W option   |               | ±150         |                 | ppm/°C       |
|   |                                     | U, T option  |               | ±50          |                 | ppm/°C       |
| V <sub>RH</sub> , V <sub>RL</sub>   | DCP terminal voltage                | V <sub>RH</sub> and V <sub>RL</sub> to GND   | V-            |              | V <sub>CC</sub> | V            |
| R <sub>W</sub>  | Wiper resistance                    | RH - floating, V <sub>RL</sub> = V-, force I <sub>W</sub> current to the wiper, I <sub>W</sub> = (V <sub>CC</sub> - V <sub>RL</sub> )/R <sub>TOTAL</sub> |               | 70           | 250             | Ω            |
| C <sub>H</sub> /C <sub>L</sub> /C <sub>W</sub> (Note 16)  | Potentiometer capacitance           | See Macro Model below.   |               | 10/10/25     |                 | pF           |
| I <sub>LkgDCP</sub>   | Leakage on DCP pins                 | Voltage at pin from GND to V <sub>CC</sub>   |               | 0.1          | 1               | μA           |
| <b>VOLTAGE DIVIDER MODE (V- @ RL; V<sub>CC</sub> @ RH; measured at R<sub>W</sub>, unloaded)</b> |                                     |  |               |              |                 |              |
| INL (Note 9)  | Integral non-linearity              | W option   | -1.5          | ±0.5         | 1.5             | LSB (Note 5) |
|   |                                     | U, T option  | -1.0          | ±0.2         | 1.0             |              |
| DNL (Note 8)  | Differential non-linearity          | W option   | -1.0          | ±0.4         | 1.0             | LSB (Note 5) |
|   |                                     | U, T option  | -0.5          | ±0.15        | 0.5             |              |
| ZSerror (Note 6)  | Zero-scale error                    | W option   | 0             | 1            | 5               | LSB (Note 5) |
|   |                                     | U, T option  | 0             | 0.5          | 2               |              |
| FSerror (Note 7)  | Full-scale error                    | W option   | -5            | -1           | 0               | LSB (Note 5) |
|   |                                     | U, T option  | -2            | -1           | 0               |              |
| TC <sub>V</sub> (Notes 10, 16)  | Ratiometric temperature coefficient | DCP register set to 80 hex   |               | ±4           |                 | ppm/°C       |

# ISL22313

**Analog Specifications** Over recommended operating conditions unless otherwise stated. Limits are established by characterization.  
(Continued)

| SYMBOL  | PARAMETER                          | TEST CONDITIONS                            | MIN<br>(Note 18) | TYP<br>(Note 4) | MAX<br>(Note 18) | UNIT            |
|---|------------------------------------|--|------------------|-----------------|------------------|-----------------|
| f <sub>cutoff</sub><br>(Note 16)  | -3dB cut off frequency             | Wiper at midpoint (80hex) W option (10k)   |                  | 1000            |                  | kHz             |
|   |                                    | Wiper at midpoint (80hex) U option (50k)   |                  | 250             |                  | kHz             |
|   |                                    | Wiper at midpoint (80hex) T option (100k)  |                  | 120             |                  | kHz             |
| <b>RESISTOR MODE</b> (Measurements between RW and RL with RH not connected, or between RW and RH with RL not connected) |                                    |  |                  |                 |                  |                 |
| RINL<br>(Note 14)   | Integral non-linearity             | W option                                   | -3               | ±1.5            | 3                | MI<br>(Note 11) |
|   |                                    | U, T option                                | -1               | ±0.3            | 1                | MI<br>(Note 11) |
| RDNL<br>(Note 13)   | Differential non-linearity         | W option                                   | -1.5             | ±0.4            | 1.5              | MI<br>(Note 11) |
|   |                                    | U, T option                                | -0.5             | ±0.15           | 0.5              | MI<br>(Note 11) |
| Roffset<br>(Note 12)  | Offset                             | W option                                   | 0                | 1               | 5                | MI<br>(Note 11) |
|   |                                    | U, T option                                | 0                | 0.5             | 2                | MI<br>(Note 11) |
| TC <sub>R</sub><br>(Notes 15, 16)   | Resistance temperature coefficient | DCP register set between 32 hex and FF hex |                  | ±50             |                  | ppm/°C          |

**Operating Specifications** Over the recommended operating conditions unless otherwise specified. Limits are established by characterization.

| SYMBOL           | PARAMETER  | TEST CONDITIONS  | MIN<br>(Note 18) | TYP<br>(Note 4) | MAX<br>(Note 18) | UNIT |
|------------------|--|--|------------------|-----------------|------------------|------|
| I <sub>CC1</sub> | V <sub>CC</sub> Supply Current (volatile write/read)     | V <sub>CC</sub> = +5.5V, V <sub>-</sub> = -5.5V, f <sub>SCL</sub> = 400kHz;<br>SDA = Open; (for I <sup>2</sup> C, active, read and write states)   |                  | 0.07            | 0.15             | mA   |
|                  |  | V <sub>CC</sub> = +2.25V, V <sub>-</sub> = -2.25V, f <sub>SCL</sub> = 400kHz;<br>SDA = Open; (for I <sup>2</sup> C, active, read and write states) |                  | 0.02            | 0.05             | mA   |
| I <sub>V-1</sub> | V <sub>-</sub> Supply Current (volatile write/read)      | V <sub>-</sub> = -5.5V, V <sub>CC</sub> = +5.5V, f <sub>SCL</sub> = 400kHz;<br>SDA = Open; (for I <sup>2</sup> C, active, read and write states)   | -1               | -0.18           |                  | mA   |
|                  |  | V <sub>-</sub> = -2.25V, V <sub>CC</sub> = +2.25V, f <sub>SCL</sub> = 400kHz;<br>SDA = Open; (for I <sup>2</sup> C, active, read and write states) | -0.4             | -0.06           |                  | mA   |
| I <sub>CC2</sub> | V <sub>CC</sub> Supply Current (non-volatile write/read) | V <sub>CC</sub> = +5.5V, V <sub>-</sub> = -5.5V, f <sub>SCL</sub> = 400kHz;<br>SDA = Open; (for I <sup>2</sup> C, active, read and write states)   |                  | 1               | 2                | mA   |
|                  |  | V <sub>CC</sub> = +2.25V, V <sub>-</sub> = -2.25V, f <sub>SCL</sub> = 400kHz;<br>SDA = Open; (for I <sup>2</sup> C, active, read and write states) |                  | 0.3             | 0.7              | mA   |
| I <sub>V-2</sub> | V <sub>-</sub> Supply Current (non-volatile write/read)  | V <sub>-</sub> = -5.5V, V <sub>CC</sub> = +5.5V, f <sub>SCL</sub> = 400kHz;<br>SDA = Open; (for I <sup>2</sup> C, active, read and write states)   | -2               | -1.2            |                  | mA   |
|                  | V <sub>-</sub> Supply Current (non-volatile write/read)  | V <sub>-</sub> = -2.25V, V <sub>CC</sub> = +2.25V, f <sub>SCL</sub> = 400kHz;<br>SDA = Open; (for I <sup>2</sup> C, active, read and write states) | -0.7             | -0.4            |                  | mA   |

# ISL22313

**Operating Specifications** Over the recommended operating conditions unless otherwise specified. Limits are established by characterization. **(Continued)**

| SYMBOL                            | PARAMETER                                     | TEST CONDITIONS  | MIN<br>(Note 18) | TYP<br>(Note 4) | MAX<br>(Note 18) | UNIT   |
|-----------------------------------|---|--|------------------|-----------------|------------------|--------|
| I <sub>SB</sub>                   | V <sub>CC</sub> Current (standby)             | V <sub>CC</sub> = +5.5V, V <sub>-</sub> = -5.5V @ +85°C, I <sup>2</sup> C interface in standby state                                     |                  | 0.2             | 1.5              | μA     |
|                                   |   | V <sub>CC</sub> = +5.5V, V <sub>-</sub> = -5.5V @ +125°C, I <sup>2</sup> C interface in standby state                                    |                  | 1               | 2.5              | μA     |
|                                   |   | V <sub>CC</sub> = +2.25V, V <sub>-</sub> = -2.25V @ +85°C, I <sup>2</sup> C interface in standby state                                   |                  | 0.1             | 1                | μA     |
|                                   |   | V <sub>CC</sub> = +2.25V, V <sub>-</sub> = -2.25V @ +125°C, I <sup>2</sup> C interface in standby state                                  |                  | 0.5             | 2                | μA     |
| I <sub>V-SB</sub>                 | V <sub>-</sub> Current (standby)              | V <sub>-</sub> = -5.5V, V <sub>CC</sub> = +5.5V @ +85°C, I <sup>2</sup> C interface in standby state                                     | -2.5             | -0.7            |                  | μA     |
|                                   |   | V <sub>-</sub> = -5.5V, V <sub>CC</sub> = +5.5V @ +125°C, I <sup>2</sup> C interface in standby state                                    | -4               | -3              |                  | μA     |
|                                   |   | V <sub>-</sub> = -2.25V, V <sub>CC</sub> = +2.25V @ +85°C, I <sup>2</sup> C interface in standby state                                   | -1.5             | -0.3            |                  | μA     |
|                                   |   | V <sub>-</sub> = -2.25V, V <sub>CC</sub> = +2.25V @ +125°C, I <sup>2</sup> C interface in standby state                                  | -3               | -1              |                  | μA     |
| I <sub>SD</sub>                   | V <sub>CC</sub> Current (shutdown)            | V <sub>CC</sub> = +5.5V, V <sub>-</sub> = -5.5V @ +85°C, I <sup>2</sup> C interface in standby state                                     |                  | 0.2             | 1.5              | μA     |
|                                   |   | V <sub>CC</sub> = +5.5V, V <sub>-</sub> = -5.5V @ +125°C, I <sup>2</sup> C interface in standby state                                    |                  | 1               | 2.5              | μA     |
|                                   |   | V <sub>CC</sub> = +2.25V, V <sub>-</sub> = -2.25V @ +85°C, I <sup>2</sup> C interface in standby state                                   |                  | 0.1             | 1                | μA     |
|                                   |   | V <sub>CC</sub> = +2.25V, V <sub>-</sub> = -2.25V @ +125°C, I <sup>2</sup> C interface in standby state                                  |                  | 0.5             | 2                | μA     |
| I <sub>V-SB</sub>                 | V <sub>-</sub> Current (standby)              | V <sub>-</sub> = -5.5V, V <sub>CC</sub> = +5.5V @ +85°C, I <sup>2</sup> C interface in standby state                                     | -2.5             | -0.7            |                  | μA     |
|                                   |   | V <sub>-</sub> = -5.5V, V <sub>CC</sub> = +5.5V @ +125°C, I <sup>2</sup> C interface in standby state                                    | -4               | -3              |                  | μA     |
|                                   |   | V <sub>-</sub> = -2.25V, V <sub>CC</sub> = +2.25V @ +85°C, I <sup>2</sup> C interface in standby state                                   | -1.5             | -0.3            |                  | μA     |
|                                   |   | V <sub>-</sub> = -2.25V, V <sub>CC</sub> = +2.25V @ +125°C, I <sup>2</sup> C interface in standby state                                  | -3               | -1              |                  | μA     |
| I <sub>LkgDig</sub>               | Leakage current, at pins A0, A1, SDA, and SCL | Voltage at pin from GND to V <sub>CC</sub>   | -1               |                 | 1                | μA     |
| t <sub>DCP</sub><br>(Note 16)     | DCP wiper response time                       | SCL falling edge of last bit of DCP data byte to wiper new position  |                  | 1.5             |                  | μs     |
| t <sub>ShdnRec</sub><br>(Note 16) | DCP recall time from shutdown mode            | SCL falling edge of last bit of ACR data byte to wiper stored position and RH connection   |                  | 1.5             |                  | μs     |
| V <sub>por</sub>                  | Power-on recall voltage                       | Minimum V <sub>CC</sub> at which memory recall occurs  | 1.9              |                 | 2.1              | V      |
| V <sub>CC</sub> Ramp              | V <sub>CC</sub> ramp rate                     |  | 0.2              |                 |                  | V/ms   |
| t <sub>D</sub>                    | Power-up delay                                | V <sub>CC</sub> above V <sub>por</sub> , to DCP Initial Value Register recall completed, and I <sup>2</sup> C interface in standby state |                  |                 | 5                | ms     |
| <b>EEPROM SPECIFICATION</b>       |   |  |                  |                 |                  |        |
|                                   | EEPROM Endurance                              |  | 1,000,000        |                 |                  | Cycles |
|                                   | EEPROM Retention                              | Temperature T ≤ +55°C  | 50               |                 |                  | Years  |
| t <sub>WC</sub><br>(Note 17)      | Non-volatile Write cycle time                 |  |                  | 12              | 20               | ms     |

**Operating Specifications** Over the recommended operating conditions unless otherwise specified. Limits are established by characterization. **(Continued)**

| SYMBOL                        | PARAMETER  | TEST CONDITIONS   | MIN<br>(Note 18)             | TYP<br>(Note 4) | MAX<br>(Note 18)      | UNIT |
|-------------------------------|--|---|------------------------------|-----------------|-----------------------|------|
| <b>SERIAL INTERFACE SPECS</b> |  |   |                              |                 |                       |      |
| V <sub>IL</sub>               | A1, A0, SDA, and SCL input buffer LOW voltage                    |   | -0.3                         |                 | 0.3*V <sub>CC</sub>   | V    |
| V <sub>IH</sub>               | A1, A0, SDA, and SCL input buffer HIGH voltage                   |   | 0.7*V <sub>CC</sub>          |                 | V <sub>CC</sub> + 0.3 | V    |
| Hysteresis<br>(Note 16)       | SDA and SCL input buffer hysteresis                              |   | 0.05*V <sub>CC</sub>         |                 |                       | V    |
| V <sub>OL</sub><br>(Note 16)  | SDA output buffer LOW voltage, sinking 4mA                       |   | 0                            |                 | 0.4                   | V    |
| C <sub>pin</sub><br>(Note 16) | A1, A0, SDA, and SCL pin capacitance                             |   |                              |                 | 10                    | pF   |
| f <sub>SCL</sub>              | SCL frequency  |   |                              |                 | 400                   | kHz  |
| t <sub>sp</sub>               | Pulse width suppression time at SDA and SCL inputs               | Any pulse narrower than the max spec is suppressed  |                              |                 | 50                    | ns   |
| t <sub>AA</sub><br>(Note 16)  | SCL falling edge to SDA output data valid                        | SCL falling edge crossing 30% of V <sub>CC</sub> , until SDA exits the 30% to 70% of V <sub>CC</sub> window   |                              |                 | 900                   | ns   |
| t <sub>BUF</sub><br>(Note 16) | Time the bus must be free before the start of a new transmission | SDA crossing 70% of V <sub>CC</sub> during a STOP condition, to SDA crossing 70% of V <sub>CC</sub> during the following START condition                              | 1300                         |                 |                       | ns   |
| t <sub>LOW</sub>              | Clock LOW time   | Measured at the 30% of V <sub>CC</sub> crossing   | 1300                         |                 |                       | ns   |
| t <sub>HIGH</sub>             | Clock HIGH time  | Measured at the 70% of V <sub>CC</sub> crossing   | 600                          |                 |                       | ns   |
| t <sub>SU:STA</sub>           | START condition setup time                                       | SCL rising edge to SDA falling edge; both crossing 70% of V <sub>CC</sub>   | 600                          |                 |                       | ns   |
| t <sub>HD:STA</sub>           | START condition hold time  | From SDA falling edge crossing 30% of V <sub>CC</sub> to SCL falling edge crossing 70% of V <sub>CC</sub>   | 600                          |                 |                       | ns   |
| t <sub>SU:DAT</sub>           | Input data setup time  | From SDA exiting the 30% to 70% of V <sub>CC</sub> window, to SCL rising edge crossing 30% of V <sub>CC</sub>   | 100                          |                 |                       | ns   |
| t <sub>HD:DAT</sub>           | Input data hold time   | From SCL rising edge crossing 70% of V <sub>CC</sub> to SDA entering the 30% to 70% of V <sub>CC</sub> window   | 0                            |                 |                       | ns   |
| t <sub>SU:STO</sub>           | STOP condition setup time  | From SCL rising edge crossing 70% of V <sub>CC</sub> , to SDA rising edge crossing 30% of V <sub>CC</sub>   | 600                          |                 |                       | ns   |
| t <sub>HD:STO</sub>           | STOP condition hold time for read, or volatile only write        | From SDA rising edge to SCL falling edge; both crossing 70% of V <sub>CC</sub>  | 1300                         |                 |                       | ns   |
| t <sub>DH</sub><br>(Note 16)  | Output data hold time  | From SCL falling edge crossing 30% of V <sub>CC</sub> , until SDA enters the 30% to 70% of V <sub>CC</sub> window   | 0                            |                 |                       | ns   |
| t <sub>R</sub><br>(Note 16)   | SDA and SCL rise time  | From 30% to 70% of V <sub>CC</sub>  | 20 +<br>0.1 * C <sub>b</sub> |                 | 250                   | ns   |
| t <sub>F</sub><br>(Note 16)   | SDA and SCL fall time  | From 70% to 30% of V <sub>CC</sub>  | 20 +<br>0.1 * C <sub>b</sub> |                 | 250                   | ns   |
| C <sub>b</sub><br>(Note 16)   | Capacitive loading of SDA or SCL                                 | Total on-chip and off-chip  | 10                           |                 | 400                   | pF   |
| R <sub>pu</sub><br>(Note 16)  | SDA and SCL bus pull-up resistor off-chip                        | Maximum is determined by t <sub>R</sub> and t <sub>F</sub><br>For C <sub>b</sub> = 400pF, max is about 2kΩ~2.5kΩ<br>For C <sub>b</sub> = 40pF, max is about 15kΩ~20kΩ | 1                            |                 |                       | kΩ   |

**Operating Specifications** Over the recommended operating conditions unless otherwise specified. Limits are established by characterization. **(Continued)**

| SYMBOL            | PARAMETER            | TEST CONDITIONS        | MIN (Note 18) | TYP (Note 4) | MAX (Note 18) | UNIT |
|-------------------|----------------------|------------------------|---------------|--------------|---------------|------|
| t <sub>SU:A</sub> | A1 and A0 setup time | Before START condition | 600           |              |               | ns   |
| t <sub>HD:A</sub> | A1 and A0 hold time  | After STOP condition   | 600           |              |               | ns   |

NOTES:

4. Typical values are for T<sub>A</sub> = +25°C and 3.3V supply voltage.
5. LSB:  $[V(RW)_{255} - V(RW)_0]/255$ . V(RW)<sub>255</sub> and V(RW)<sub>0</sub> are V(RW) for the DCP register set to FF hex and 00 hex respectively. LSB is the incremental voltage when changing from one tap to an adjacent tap.
6. ZS error = V(RW)<sub>0</sub>/LSB.
7. FS error =  $[V(RW)_{255} - V_{CC}]/LSB$ .
8. DNL =  $[V(RW)_i - V(RW)_{i-1}]/LSB - 1$ , for i = 1 to 255. i is the DCP register setting.
9. INL =  $[V(RW)_i - i \cdot LSB - V(RW)_0]/LSB$  for i = 1 to 255
10.  $TC_V = \frac{Max(V(RW)_i) - Min(V(RW)_i)}{[Max(V(RW)_i) + Min(V(RW)_i)]/2} \times \frac{10^6}{+165^\circ C}$  for i = 16 to 255 decimal, T = -40°C to +125°C. Max ( ) is the maximum value of the wiper voltage and Min ( ) is the minimum value of the wiper voltage over the temperature range.
11. MI =  $|RW_{255} - RW_0|/255$ . MI is a minimum increment. RW<sub>255</sub> and RW<sub>0</sub> are the measured resistances for the DCP register set to FF hex and 00 hex respectively.
12. Roffset = RW<sub>0</sub>/MI, when measuring between RW and RL.  
Roffset = RW<sub>255</sub>/MI, when measuring between RW and RH.
13. RDNL =  $(RW_i - RW_{i-1})/MI - 1$ , for i = 16 to 255.
14. RINL =  $[RW_i - (MI \cdot i) - RW_0]/MI$ , for i = 16 to 255.
15.  $TC_R = \frac{[Max(Ri) - Min(Ri)]}{[Max(Ri) + Min(Ri)]/2} \times \frac{10^6}{+165^\circ C}$  for i = 16 to 255, T = -40°C to +125°C. Max ( ) is the maximum value of the resistance and Min ( ) is the minimum value of the resistance over the temperature range.
16. Limits should be considered typical and are not production tested.
17. t<sub>WC</sub> is the time from a valid STOP condition at the end of a Write sequence of I<sup>2</sup>C serial interface, to the end of the self-timed internal non-volatile write cycle.
18. Parts are 100% tested at +25°C. Over temperature limits established by characterization and are not production tested.

**DCP Macro Model**

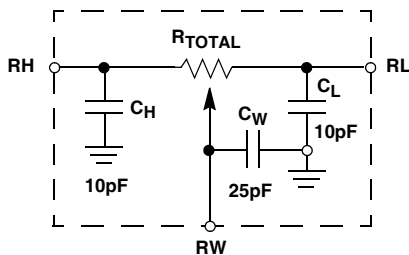

**SDA vs SCL Timing**

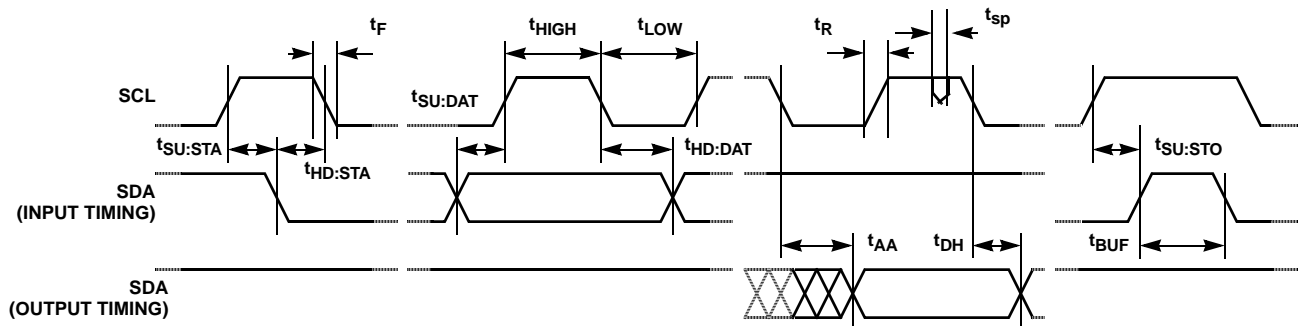

A0 and A1 Pin Timing

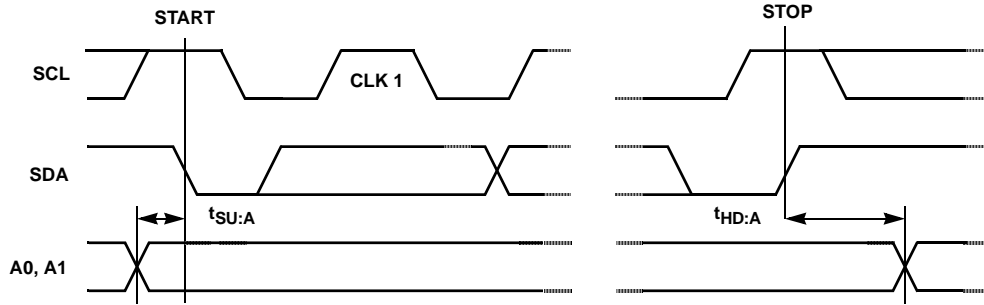

Typical Performance Curves

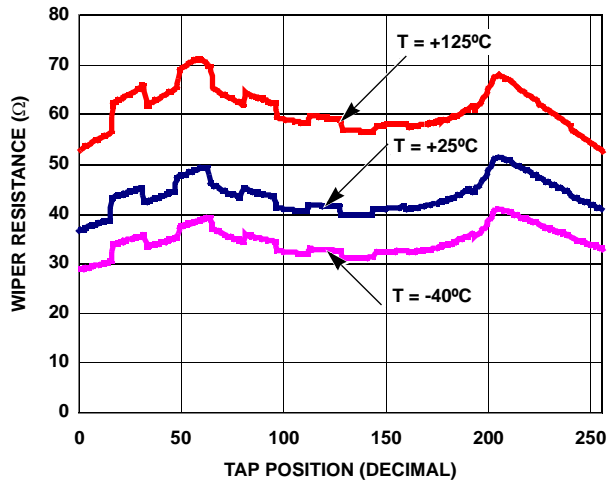

FIGURE 1. WIPER RESISTANCE vs TAP POSITION [  $I(RW) = V_{CC}/R_{TOTAL}$  ] FOR 10k $\Omega$  (W)

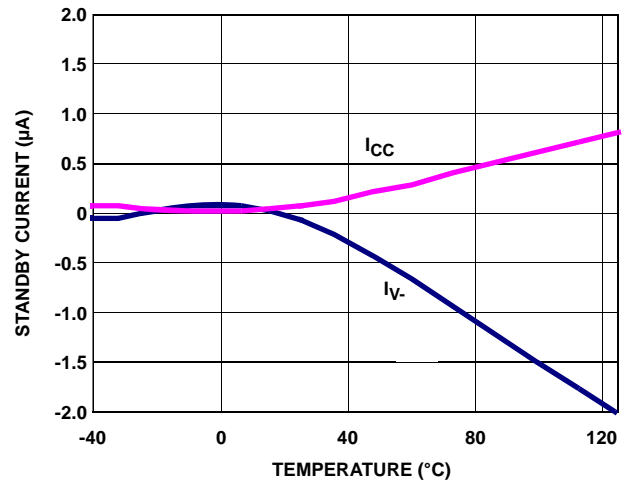

FIGURE 2. STANDBY  $I_{CC}$  AND  $I_{V-}$  vs TEMPERATURE

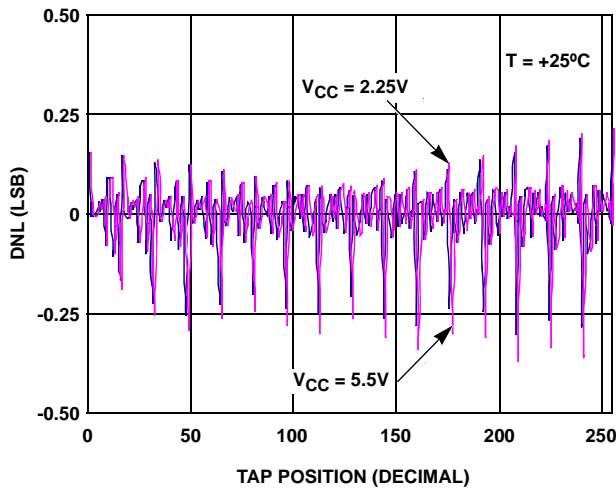

FIGURE 3. DNL vs TAP POSITION IN VOLTAGE DIVIDER MODE FOR 10k $\Omega$  (W)

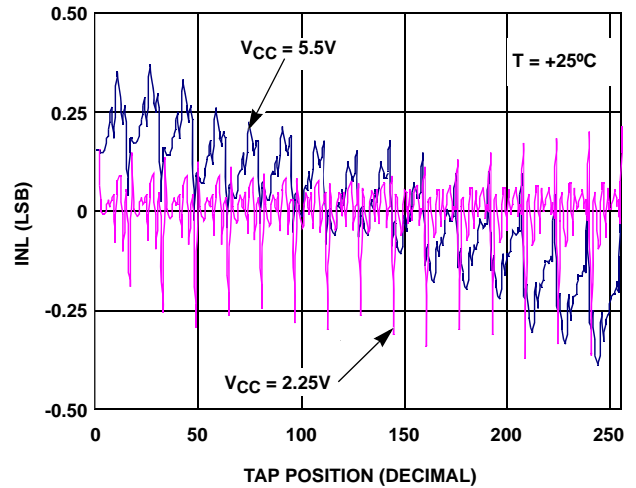

FIGURE 4. INL vs TAP POSITION IN VOLTAGE DIVIDER MODE FOR 10k $\Omega$  (W)



Typical Performance Curves (Continued)

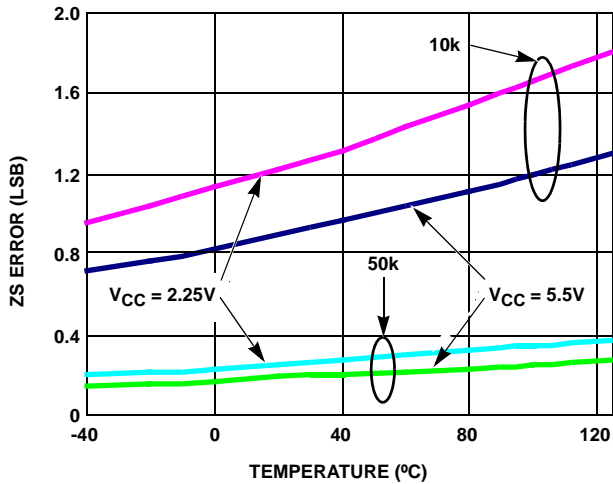

FIGURE 5. ZS ERROR vs TEMPERATURE

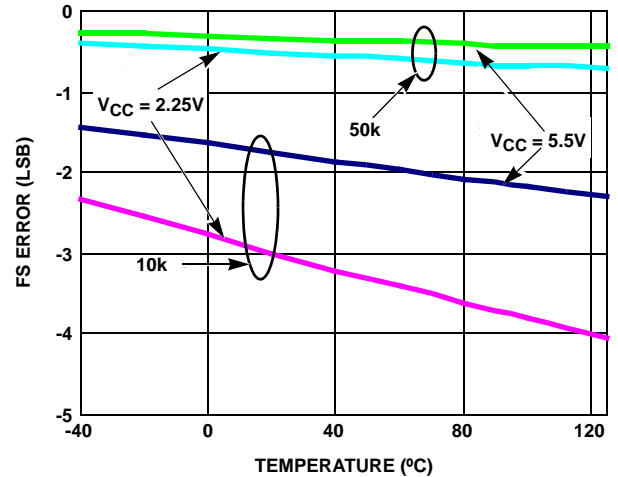

FIGURE 6. FS ERROR vs TEMPERATURE

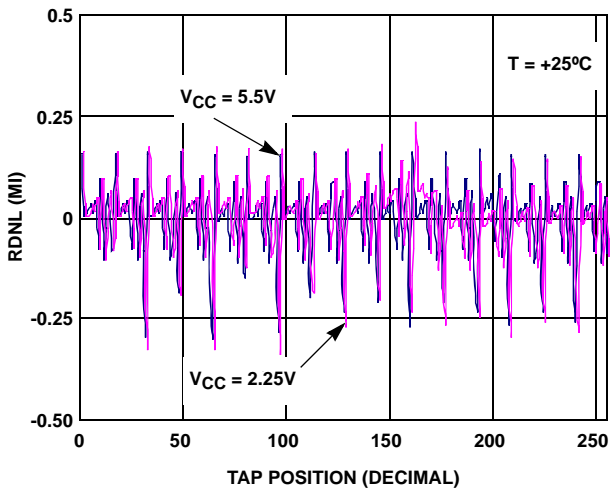

FIGURE 7. DNL vs TAP POSITION IN RHEOSTAT MODE FOR 10kΩ (W)

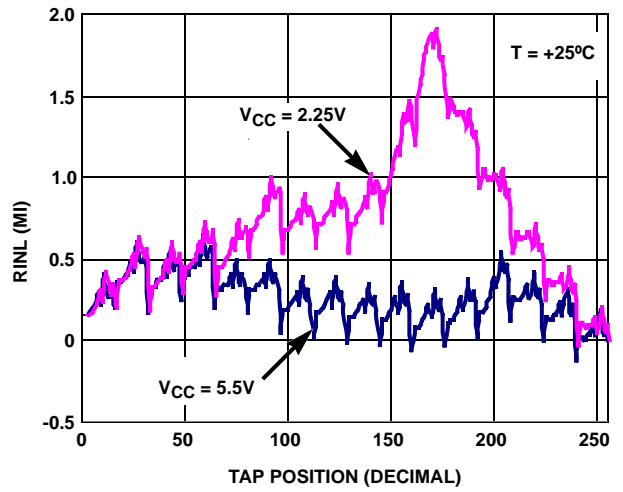

FIGURE 8. INL vs TAP POSITION IN RHEOSTAT MODE FOR 10kΩ (W)

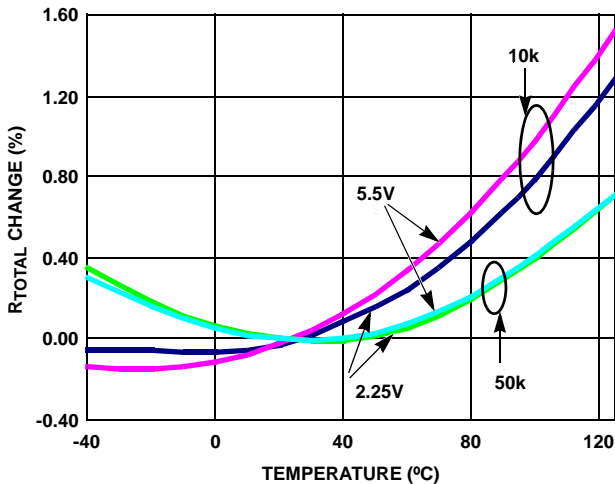

FIGURE 9. END TO END  $R_{TOTAL}$  % CHANGE vs TEMPERATURE

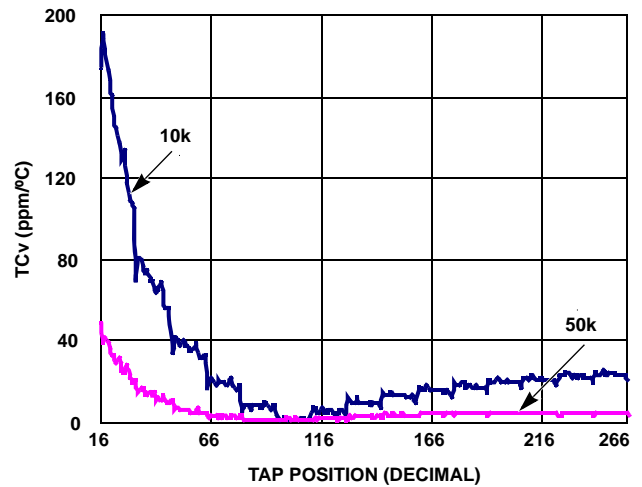

FIGURE 10. TC FOR VOLTAGE DIVIDER MODE IN ppm

Typical Performance Curves (Continued)

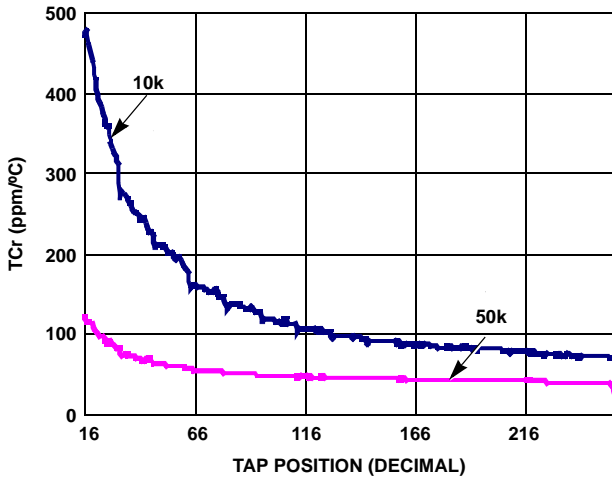

FIGURE 11. TC FOR RHEOSTAT MODE IN ppm

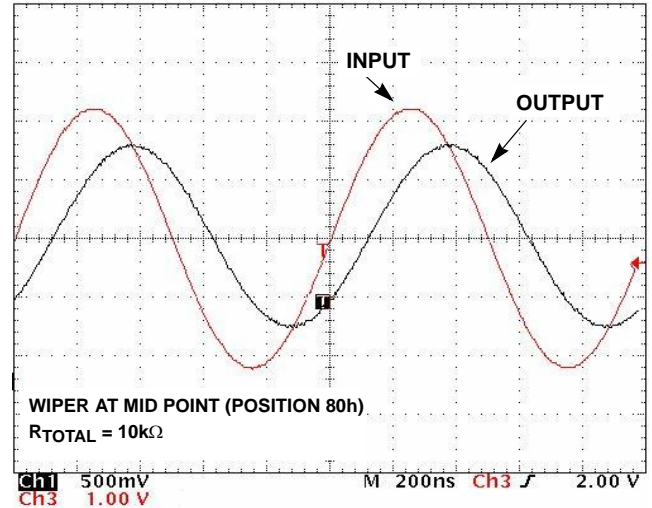

FIGURE 12. FREQUENCY RESPONSE (1MHz)

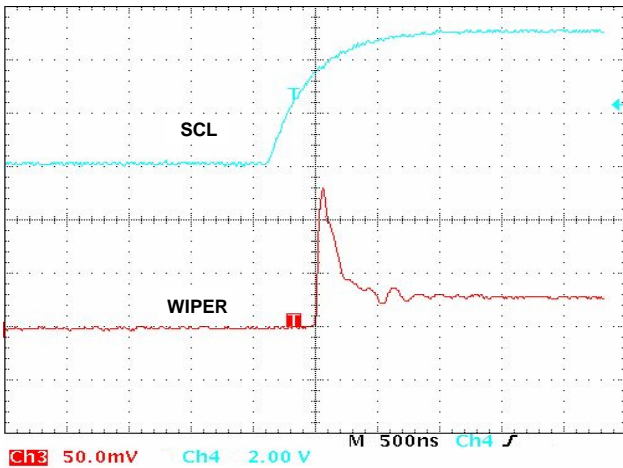

FIGURE 13. MIDSACLE GLITCH, CODE 7Fh TO 80h

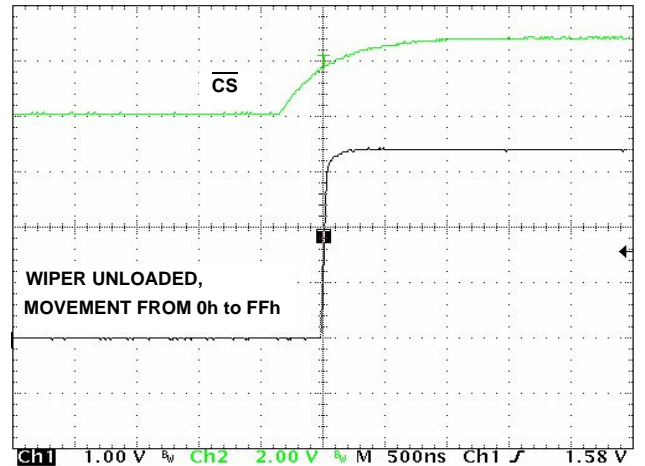

FIGURE 14. LARGE SIGNAL SETTLING TIME

Pin Description

Potentiometers Pins

RH and RL

The high (RH) and low (RL) terminals of the ISL22313 are equivalent to the fixed terminals of a mechanical potentiometer. RH and RL are referenced to the relative position of the wiper and not the voltage potential on the terminals. With WR set to 255 decimal, the wiper will be closest to RH, and with the WR set to 0, the wiper is closest to RL.

RW

RW is the wiper terminal, and it is equivalent to the movable terminal of a mechanical potentiometer. The position of the wiper within the array is determined by the WR register.

Bus Interface Pins

Serial Data Input/Output (SDA)

The SDA is a bidirectional serial data input/output pin for I<sup>2</sup>C interface. It receives device address, operation code, wiper address and data from an I<sup>2</sup>C external master device at the rising edge of the serial clock SCL, and it shifts out data after each falling edge of the serial clock.

SDA requires an external pull-up resistor, since it is an open drain input/output.

Serial Clock (SCL)

This input is the serial clock of the I<sup>2</sup>C serial interface. SCL requires an external pull-up resistor, since it is an open drain input.

## Device Address (A1, A0)

The address inputs are used to set the least significant 2 bits of the 7-bit I<sup>2</sup>C interface slave address. A match in the slave address serial data stream must match with the Address input pins in order to initiate communication with the ISL22313. A maximum of four ISL22313 devices may occupy the I<sup>2</sup>C serial bus (see Table 3).

## Principles of Operation

The ISL22313 is an integrated circuit incorporating one DCP with its associated registers, non-volatile memory and an I<sup>2</sup>C serial interface providing direct communication between a host and the potentiometer and memory. The resistor array is comprised of individual resistors connected in series. At either end of the array and between each resistor is an electronic switch that transfers the potential at that point to the wiper.

The electronic switches on the device operate in a “make before break” mode when the wiper changes tap positions.

When the device is powered down, the last value stored in IVR will be maintained in the non-volatile memory. When power is restored, the contents of the IVR are recalled and loaded into the WR to set the wiper to the initial value.

## DCP Description

The DCP is implemented with a combination of resistor elements and CMOS switches. The physical ends of each DCP are equivalent to the fixed terminals of a mechanical potentiometer (RH and RL pins). The RW pin of the DCP is connected to intermediate nodes, and is equivalent to the wiper terminal of a mechanical potentiometer. The position of the wiper terminal within the DCP is controlled by an 8-bit volatile Wiper Register (WR). When the WR of a DCP contains all zeroes (WR[7:0]= 00h), its wiper terminal (RW) is closest to its “Low” terminal (RL). When the WR register of a DCP contains all ones (WR[7:0]= FFh), its wiper terminal (RW) is closest to its “High” terminal (RH). As the value of the WR increases from all zeroes (0) to all ones (255 decimal), the wiper moves monotonically from the position closest to RL to the position closest to RH. At the same time, the resistance between RW and RL increases monotonically, while the resistance between RH and RW decreases monotonically.

While the ISL22313 is being powered up, the WR is reset to 80h (128 decimal), which locates RW roughly at the center between RL and RH. After the power supply voltage becomes large enough for reliable non-volatile memory reading, the WR will be reloaded with the value stored in a non-volatile Initial Value Register (IVR).

The WR and IVR can be read or written to directly using the I<sup>2</sup>C serial interface as described in the following sections.

## Memory Description

The ISL22313 contains one non-volatile 8-bit Initial Value Register (IVR), fourteen General Purpose non-volatile 8-bit registers and two volatile 8-bit registers: Wiper Register (WR) and Access Control Register (ACR). Memory map of ISL22313 is in Table 1. The non-volatile register (IVR) at address 0, contains initial wiper position and volatile register (WR) contains current wiper position.

TABLE 1. MEMORY MAP

| ADDRESS (hex) | NON-VOLATILE    | VOLATILE |
|---------------|-----------------|----------|
| 10            | N/A             | ACR      |
| F             | Reserved        |          |
| E             | General Purpose | N/A      |
| D             | General Purpose | N/A      |
| C             | General Purpose | N/A      |
| B             | General Purpose | N/A      |
| A             | General Purpose | N/A      |
| 9             | General Purpose | N/A      |
| 8             | General Purpose | N/A      |
| 7             | General Purpose | N/A      |
| 6             | General Purpose | N/A      |
| 5             | General Purpose | N/A      |
| 4             | General Purpose | N/A      |
| 3             | General Purpose | N/A      |
| 2             | General Purpose | N/A      |
| 1             | General Purpose | N/A      |
| 0             | IVR             | WR       |

The non-volatile IVR and volatile WR registers are accessible with the same address.

The Access Control Register (ACR) contains information and control bits described below in Table 2.

The VOL bit (ACR[7]) determines whether the access to wiper registers WR or initial value registers IVR.

TABLE 2. ACCESS CONTROL REGISTER (ACR)

| BIT # | 7   | 6                        | 5   | 4 | 3 | 2 | 1 | 0 |
|-------|-----|--------------------------|-----|---|---|---|---|---|
| NAME  | VOL | $\overline{\text{SHDN}}$ | WIP | 0 | 0 | 0 | 0 | 0 |

If VOL bit is 0, the non-volatile IVR register is accessible. If VOL bit is 1, only the volatile WR is accessible. Note: Value is written to IVR register also is written to the WR. The default value of this bit is 0.

The  $\overline{\text{SHDN}}$  bit (ACR[6]) disables or enables Shutdown mode. When this bit is 0, i.e. DCP is forced to end-to-end open circuit and RW is shorted to RL as shown on Figure 15. Default value of the  $\overline{\text{SHDN}}$  bit is 1.

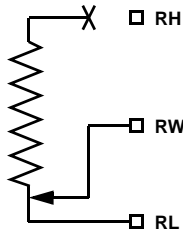

FIGURE 15. DCP CONNECTION IN SHUTDOWN MODE

The WIP bit (ACR[5]) is a read-only bit. It indicates that non-volatile write operation is in progress. It is impossible to write to the WR or ACR while WIP bit is 1.

**I<sup>2</sup>C Serial Interface**

The ISL22313 supports an I<sup>2</sup>C bidirectional bus oriented protocol. The protocol defines any device that sends data onto the bus as a transmitter and the receiving device as the receiver. The device controlling the transfer is a master and the device being controlled is the slave. The master always initiates data transfers and provides the clock for both transmit and receive operations. Therefore, the ISL22313 operates as a slave device in all applications.

All communication over the I<sup>2</sup>C interface is conducted by sending the MSB of each byte of data first.

**Protocol Conventions**

Data states on the SDA line must change only during SCL LOW periods. SDA state changes during SCL HIGH are reserved for indicating START and STOP conditions (see Figure 16). On power-up of the ISL22313, the SDA pin is in the input mode.

All I<sup>2</sup>C interface operations must begin with a START condition, which is a HIGH to LOW transition of SDA while SCL is HIGH. The ISL22313 continuously monitors the SDA and SCL lines for the START condition and does not respond to any command until this condition is met (see Figure 16). A START condition is ignored during the power-up of the device.

All I<sup>2</sup>C interface operations must be terminated by a STOP condition, which is a LOW to HIGH transition of SDA while SCL is HIGH (see Figure 16). A STOP condition at the end of a read operation, or at the end of a write operation places the device in its standby mode.

An ACK (Acknowledge) is a software convention used to indicate a successful data transfer. The transmitting device, either master or slave, releases the SDA bus after transmitting eight bits. During the ninth clock cycle, the receiver pulls the SDA line LOW to acknowledge the reception of the eight bits of data (see Figure 17).

The ISL22313 responds with an ACK after recognition of a START condition followed by a valid Identification Byte, and once again after successful receipt of an Address Byte. The ISL22313 also responds with an ACK after receiving a Data Byte of a write operation. The master must respond with an ACK after receiving a Data Byte of a read operation

A valid Identification Byte contains 10100 as the five MSBs, and the following two bits matching the logic values present at pins A1 and A0. The LSB is the Read/Write bit. Its value is "1" for a Read operation and "0" for a Write operation (see Table 3).

TABLE 3. IDENTIFICATION BYTE FORMAT  
LOGIC VALUES AT PINS A1 AND A0, RESPECTIVELY

|       |   |   |   |   |       |    |     |
|-------|---|---|---|---|-------|----|-----|
| 1     | 0 | 1 | 0 | 0 | A1    | A0 | R/W |
| (MSB) |   |   |   |   | (LSB) |    |     |

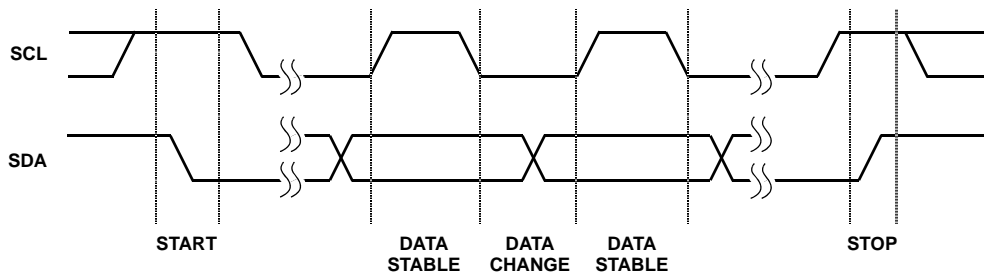

FIGURE 16. VALID DATA CHANGES, START AND STOP CONDITIONS

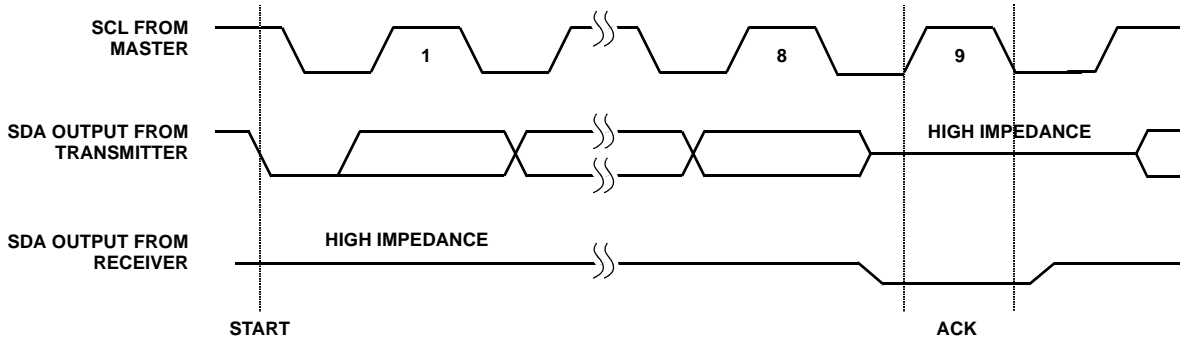

FIGURE 17. ACKNOWLEDGE RESPONSE FROM RECEIVER

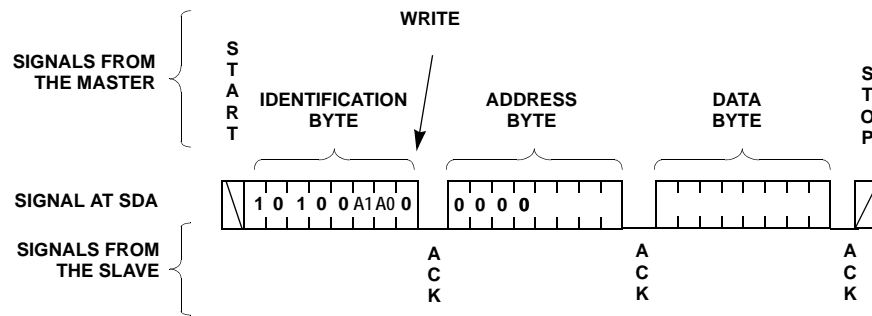

FIGURE 18. BYTE WRITE SEQUENCE

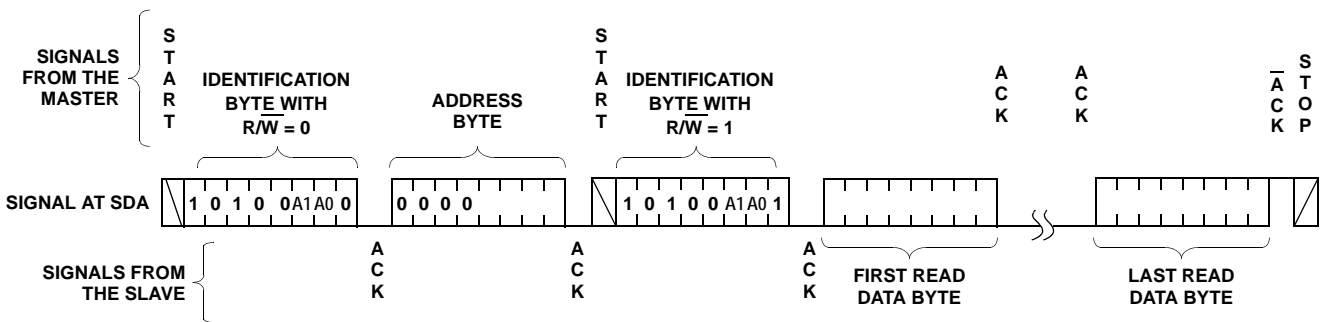

FIGURE 19. READ SEQUENCE

**Write Operation**

A Write operation requires a START condition, followed by a valid Identification Byte, a valid Address Byte, a Data Byte, and a STOP condition. After each of the three bytes, the ISL22313 responds with an ACK. At this time, the device enters its standby state (see Figure 18).

The non-volatile write cycle starts after STOP condition is determined and it requires up to 20ms delay for the next non-volatile write. Thus, non-volatile registers must be written individually.

**Read Operation**

A Read operation consist of a three byte instruction followed by one or more Data Bytes (see Figure 19). The master initiates the operation issuing the following sequence: a START, the Identification byte with the R/W bit set to "0", an Address Byte, a second START, and a second Identification byte with the R/W bit set to "1". After each of the three bytes, the ISL22313 responds with an ACK. Then the ISL22313 transmits Data Bytes as long as the master responds with an ACK during the SCL cycle following the eighth bit of each byte. The Data Bytes are from the registers indicated by an internal pointer. This pointer initial value is determined by the Address Byte in the Read operation instruction, and

increments by one during transmission of each Data Byte. After reaching the memory location 0Fh, the pointer “rolls over” to 00h, and the device continues to output data for each ACK received. The master terminates the read operation issuing a NACK ( $\overline{\text{ACK}}$ ) and a STOP condition following the last bit of the last Data Byte (see Figure 19).

### **Applications Information**

When stepping up through each tap in voltage divider mode, some tap transition points can result in noticeable voltage transients (or overshoot/undershoot) resulting from the sudden transition from a very low impedance “make” to a much higher impedance “break within an extremely short period of time (<50ns). Two such code transitions are EFh to F0h, and 0Fh to 10h. Note that all switching transients will settle well within the settling time as stated in the datasheet. A small capacitor can be added externally to reduce the amplitude of these voltage transients, but that will also reduce the useful bandwidth of the circuit, thus this may not be a good solution for some applications. It may be a good idea, in that case, to use fast amplifiers in a signal chain for fast recovery.

Mini Small Outline Plastic Packages (MSOP)

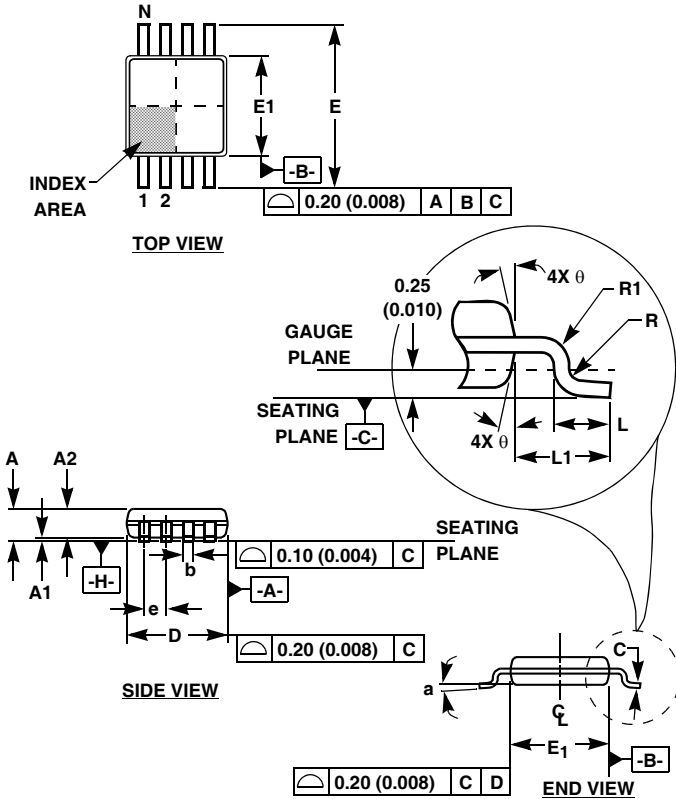

M10.118 (JEDEC MO-187BA)  
10 LEAD MINI SMALL OUTLINE PLASTIC PACKAGE

| SYMBOL | INCHES    |       | MILLIMETERS |      | NOTES |
|--------|-----------|-------|-------------|------|-------|
|        | MIN       | MAX   | MIN         | MAX  |       |
| A      | 0.037     | 0.043 | 0.94        | 1.10 | -     |
| A1     | 0.002     | 0.006 | 0.05        | 0.15 | -     |
| A2     | 0.030     | 0.037 | 0.75        | 0.95 | -     |
| b      | 0.007     | 0.011 | 0.18        | 0.27 | 9     |
| c      | 0.004     | 0.008 | 0.09        | 0.20 | -     |
| D      | 0.116     | 0.120 | 2.95        | 3.05 | 3     |
| E1     | 0.116     | 0.120 | 2.95        | 3.05 | 4     |
| e      | 0.020 BSC |       | 0.50 BSC    |      | -     |
| E      | 0.187     | 0.199 | 4.75        | 5.05 | -     |
| L      | 0.016     | 0.028 | 0.40        | 0.70 | 6     |
| L1     | 0.037 REF |       | 0.95 REF    |      | -     |
| N      | 10        |       | 10          |      | 7     |
| R      | 0.003     | -     | 0.07        | -    | -     |
| R1     | 0.003     | -     | 0.07        | -    | -     |
| θ      | 5°        | 15°   | 5°          | 15°  | -     |
| α      | 0°        | 6°    | 0°          | 6°   | -     |

Rev. 0 12/02

NOTES:

1. These package dimensions are within allowable dimensions of JEDEC MO-187BA.
2. Dimensioning and tolerancing per ANSI Y14.5M-1994.
3. Dimension "D" does not include mold flash, protrusions or gate burrs and are measured at Datum Plane. Mold flash, protrusion and gate burrs shall not exceed 0.15mm (0.006 inch) per side.
4. Dimension "E1" does not include interlead flash or protrusions and are measured at Datum Plane. [-H-] Interlead flash and protrusions shall not exceed 0.15mm (0.006 inch) per side.
5. Formed leads shall be planar with respect to one another within 0.10mm (.004) at seating Plane.
6. "L" is the length of terminal for soldering to a substrate.
7. "N" is the number of terminal positions.
8. Terminal numbers are shown for reference only.
9. Dimension "b" does not include dambar protrusion. Allowable dambar protrusion shall be 0.08mm (0.003 inch) total in excess of "b" dimension at maximum material condition. Minimum space between protrusion and adjacent lead is 0.07mm (0.0027 inch).
10. Datums [-A-] and [-B-] to be determined at Datum plane [-H-].
11. Controlling dimension: MILLIMETER. Converted inch dimensions are for reference only

All Intersil U.S. products are manufactured, assembled and tested utilizing ISO9000 quality systems.  
Intersil Corporation's quality certifications can be viewed at [www.intersil.com/design/quality](http://www.intersil.com/design/quality)

*Intersil products are sold by description only. Intersil Corporation reserves the right to make changes in circuit design, software and/or specifications at any time without notice. Accordingly, the reader is cautioned to verify that data sheets are current before placing orders. Information furnished by Intersil is believed to be accurate and reliable. However, no responsibility is assumed by Intersil or its subsidiaries for its use; nor for any infringements of patents or other rights of third parties which may result from its use. No license is granted by implication or otherwise under any patent or patent rights of Intersil or its subsidiaries.*

For information regarding Intersil Corporation and its products, see [www.intersil.com](http://www.intersil.com)