



# Praetorian™ L-C EMI Filter with ESD Protection for Headset Speakers

## CM1418

### Features

- Two channels of EMI filtering
- $\pm 30\text{kV}$  ESD protection (IEC 61000-4-2, contact discharge)
- $\pm 30\text{kV}$  ESD protection (HBM)
- *OptiGuard*™ Coating for improved reliability at assembly
- Greater than 35dB of attenuation at 1GHz
- 6-bump, 1.720mm x 1.220mm footprint Chip Scale Package (CSP)
- RoHS-compliant, lead-free finishing

### Applications

- Headset Speaker port in mobile handsets
- I/O port protection for mobile handsets, notebook computers, PDAs etc.
- EMI filtering for data ports in cell phones, PDAs or notebook computers.

### Product Description

The CM1418 is an L-C EMI filter array with ESD protection that integrates two Pi-filters (C-L-C) for a headset speaker. The CM1418 has component values of 117pF/3.0nH/117pF. The parts include ESD protection diodes on all input/output pins, and provide a very high level of protection for sensitive electronic components against possible electrostatic discharge (ESD). The ESD diodes connected to the filter ports safely dissipate ESD strikes of  $\pm 30\text{kV}$ , which is beyond the maximum requirement of the IEC61000-4-2 international standard. In accordance with MIL-STD-883 (Method 3015) specification for Human Body Model (HBM) ESD, the pins are protected for contact discharges at greater than  $\pm 30\text{kV}$ .

This device is particularly well suited for portable electronics (e.g. mobile handsets, PDAs, notebook computers) because of its small package format and easy-to-use pin assignments. In particular, the CM1418 is ideal for EMI filtering and protecting speaker output lines of the headset speaker from ESD in mobile handsets. Most speakers have an impedance of  $8\Omega$ . However, to maximize the power output, the resistance of an EMI filter needs to be as low as possible. The CM1418 addresses this by using a C-L-C based EMI filter with an inductor having less than  $0.35\Omega$  of resistance.

The CM1418 comes with *OptiGuard*™ coating resulting in improved reliability at assembly. The CM1418 is housed in a space saving, low profile Chip Scale Package with RoHS-compliant, lead-free finishing.

**Block Diagram**

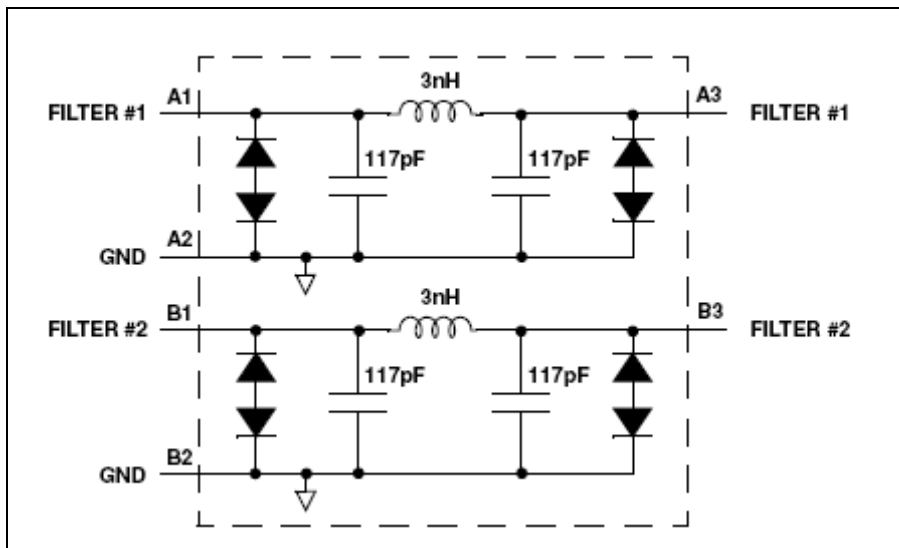

**PACKAGE / PINOUT DIAGRAMS**

TOP VIEW  
(Bumps Down View)

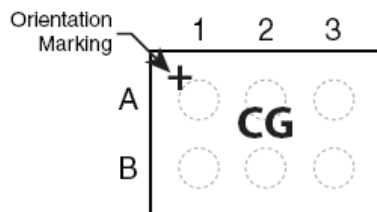

BOTTOM VIEW  
(Bumps Up View)

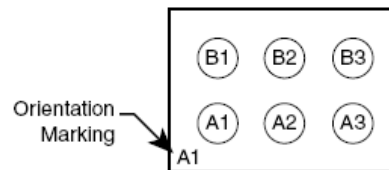

CM1418  
CSP Package

Notes:

- 1) These drawings are not to scale.

CM1418

### PIN DESCRIPTIONS

PIN	NAME	DESCRIPTION
A1	Filter #1	Filter #1 Input
A2	GND	Device Ground
A3	Filter #1	Filter #1 Input
B1	Filter #2	Filter #2 Input
B2	GND	Device Ground
B3	Filter #2	Filter #2 Input

### Ordering Information

#### PART NUMBERING INFORMATION

Pins	Package	Lead-free Finish	
		Ordering Part Number <sup>1</sup>	Part Marking
6	CSP	CM1418-02CP	CG

Note 1: Parts are shipped in Tape and Reel form unless otherwise specified.

### Specifications

#### ABSOLUTE MAXIMUM RATINGS

PARAMETER	RATING	UNITS
Storage Temperature Range	-65 to +150	°C
DC Current per Inductor	500	mA
DC Package Power Rating	0.5	W

#### STANDARD OPERATING CONDITIONS

PARAMETER	RATING	UNITS
Operating Temperature Range	-40 to +85	°C

**ELECTRICAL OPERATING CHARACTERISTICS** (SEE NOTE 1)

SYMBOL	PARAMETER	CONDITIONS	MIN	TYP	MAX	UNITS
L	Inductance			3.0		nH
R	DC Channel Resistance			0.28	0.35	$\Omega$
C <sub>TOT</sub>	Total Channel Capacitance	2.5V dc, 1MHz, 30mV ac,	187	234	281	pF
C <sub>1</sub>	Capacitance C <sub>1</sub>	2.5V dc, 1MHz, 30mV ac	93	117	140	pF
V <sub>ST</sub>	Stand-off Voltage	I = 10 $\mu$ A		6.0		V
I <sub>LEAK</sub>	Diode Leakage Current	V <sub>IN</sub> = 3.3V		0.1	1.0	$\mu$ A
V <sub>SIG</sub>	Signal Clamp Voltage Positive Clamp Negative Clamp	I <sub>LOAD</sub> = 10mA I <sub>LOAD</sub> = -10mA	5.6 -9.0	6.8 -6.8	9.0 -5.6	V V
V <sub>ESD</sub>	In-system ESD Withstand Voltage a) Human Body Model, MIL-STD-883, Method 3015 b) Contact Discharge per IEC 61000-4-2 Level 4	Note 2	$\pm$ 30 $\pm$ 30			kV kV
R <sub>DYN</sub>	Dynamic Resistance Positive Negative			0.95 0.90		$\Omega$ $\Omega$
f <sub>C</sub>	Cut-off frequency Z <sub>SOURCE</sub> = 50 $\Omega$ , Z <sub>LOAD</sub> = 50 $\Omega$	L = 3nH, C = 117pF		22		MHz

Note 1: T<sub>A</sub>=25°C unless otherwise specified.

Note 2: ESD applied to input and output pins with respect to GND, one at a time.

## Performance Information

Typical Filter Performance (nominal conditions unless specified otherwise, 50 Ohm Environment)

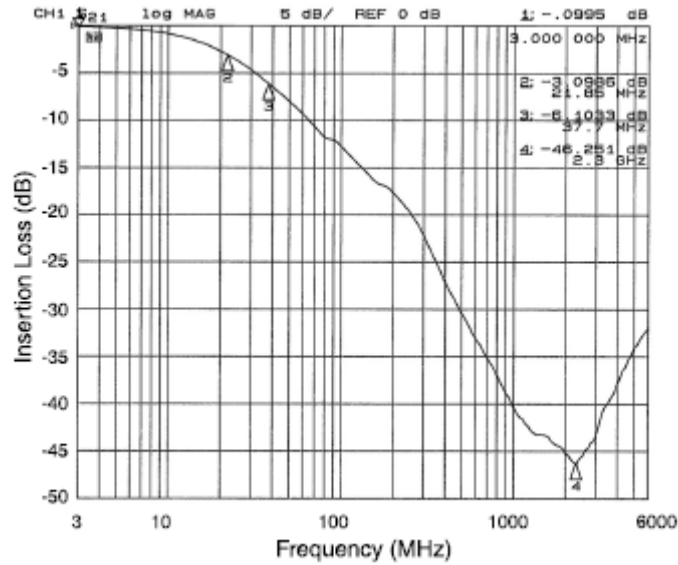

Figure 1. Insertion Loss vs. Frequency (Filter #1 to GND B2)

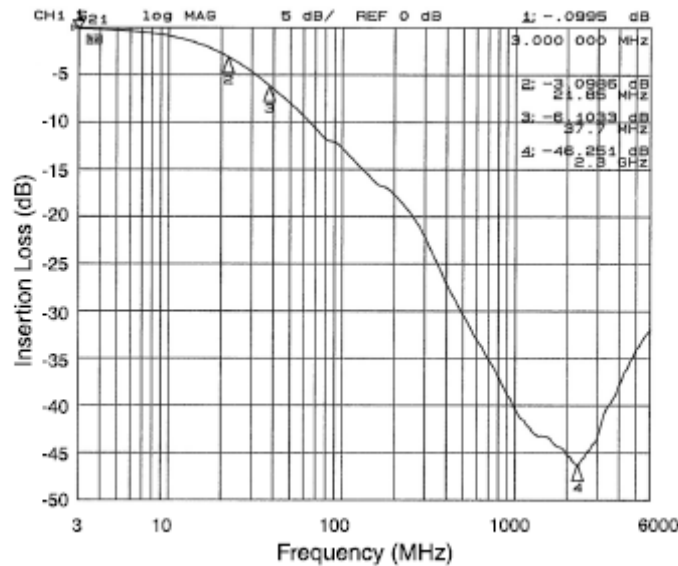

Figure 2. Insertion Loss vs. Frequency (Filter #2 to GND B2)

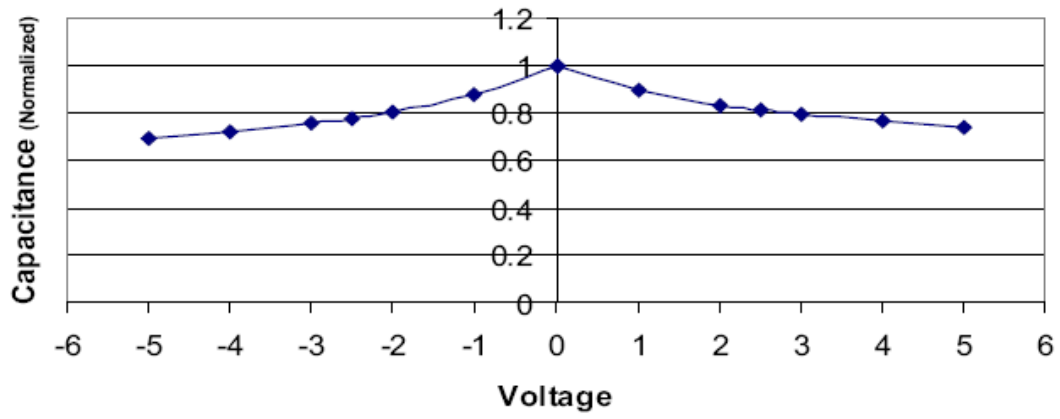

Figure 3. Typical Diode Capacitance vs. Input Voltage (normalized to 2.5VDC)

## Application Information

PARAMETER	VALUE
Pad Size on PCB	0.240mm
Pad Shape	Round
Pad Definition	Non-Solder Mask defined pads
Solder Mask Opening	0.290mm Round
Solder Stencil Thickness	0.125mm - 0.150mm
Solder Stencil Aperture Opening (laser cut, 5% tapered walls)	0.300mm Round
Solder Flux Ratio	50/50 by volume
Solder Paste Type	No Clean
Pad Protective Finish	OSP (Entek Cu Plus 106A)
Tolerance — Edge To Corner Ball	$\pm 50\mu\text{m}$
Solder Ball Side Coplanarity	$\pm 20\mu\text{m}$
Maximum Dwell Time Above Liquidous	60 seconds
Maximum Soldering Temperature for Lead-free Devices using a Lead-free Solder Paste	260°C

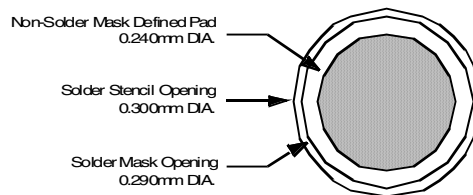

Figure 5. Recommended Non-Solder Mask Defined Pad Illustration

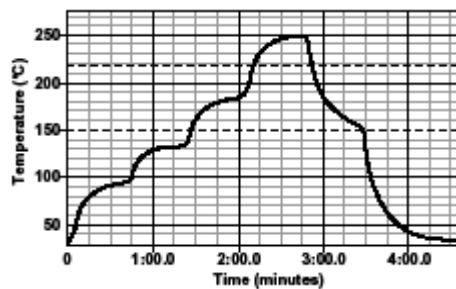

Figure 6. Lead-free (SnAgCu) Solder Ball Reflow Profile

## Mechanical Details

### CM1418 CSP Mechanical Specifications

The CM1418 is supplied in 6-bump Chip Scale Package (CSP). Dimensions are presented below.

PACKAGE DIMENSIONS						
Package	Custom CSP					
Bumps	6					
Dim	Millimeters			Inches		
	Min	Nom	Max	Min	Nom	Max
A1	1.175	1.220	1.265	0.0463	0.0480	0.0498
A2	1.675	1.720	1.765	0.0659	0.0677	0.0695
B1	0.495	0.500	0.505	0.0195	0.0197	0.0199
B2	0.495	0.500	0.505	0.0195	0.0197	0.0199
C1	0.310	0.360	0.410	0.0122	0.0142	0.0161
C2	0.310	0.360	0.410	0.0122	0.0142	0.0161
D1	0.575	0.644	0.714	0.0226	0.0254	0.0281
D2	0.368	0.419	0.470	0.0145	0.0165	0.0185
# per tape and reel	3500 pieces					
Controlling dimension: millimeters						

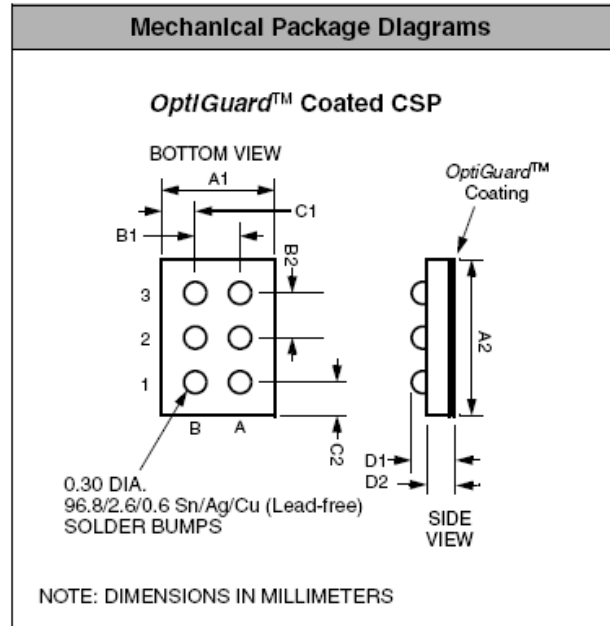

**Package Dimensions for CM1418-02CP  
6-bump Chip Scale Package**



**Mechanical Details (cont'd)**

**CSP Tape and Reel Specifications**

PART NUMBER	CHIP SIZE (mm)	POCKET SIZE (mm) $B_0 \times A_0 \times K_0$	TAPE WIDTH W	REEL DIA.	QTY PER REEL	$P_0$	$P_1$
CM1418-02CP	1.72 X 1.22 X 0.64	1.78 x 1.38 x 0.76	8mm	178mm (7")	3500	4mm	4mm

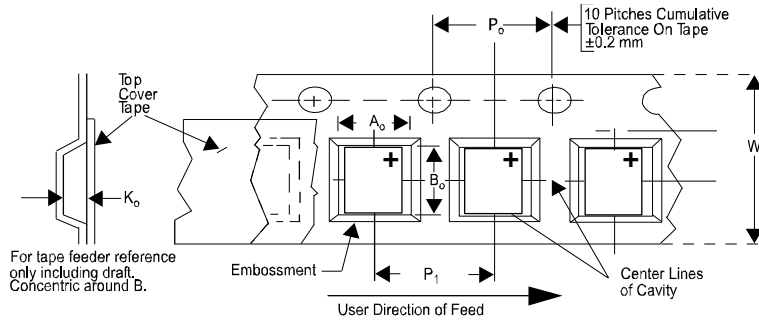

**Figure 6. Tape and Reel Mechanical Data**

ON Semiconductor and  are registered trademarks of Semiconductor Components Industries, LLC (SCILLC). SCILLC reserves the right to make changes without further notice to any products herein. SCILLC makes no warranty, representation or guarantee regarding the suitability of its products for any particular purpose, nor does SCILLC assume any liability arising out of the application or use of any product or circuit, and specifically disclaims any and all liability, including without limitation special, consequential or incidental damages. "Typical" parameters which may be provided in SCILLC data sheets and/or specifications can and do vary in different applications and actual performance may vary over time. All operating parameters, including "Typicals" must be validated for each customer application by customer's technical experts. SCILLC does not convey any license under its patent rights nor the rights of others. SCILLC products are not designed, intended, or authorized for use as components in systems intended for surgical implant into the body, or other applications intended to support or sustain life, or for any other application in which the failure of the SCILLC product could create a situation where personal injury or death may occur. Should Buyer purchase or use SCILLC products for any such unintended or unauthorized application, Buyer shall indemnify and hold SCILLC and its officers, employees, subsidiaries, affiliates, and distributors harmless against all claims, costs, damages, and expenses, and reasonable attorney fees arising out of, directly or indirectly, any claim of personal injury or death associated with such unintended or unauthorized use, even if such claim alleges that SCILLC was negligent regarding the design or manufacture of the part. SCILLC is an Equal Opportunity/Affirmative Action Employer. This literature is subject to all applicable copyright laws and is not for resale in any manner.

## PUBLICATION ORDERING INFORMATION

### LITERATURE FULFILLMENT:

Literature Distribution Center for ON Semiconductor  
P.O. Box 5163, Denver, Colorado 80217 USA  
**Phone:** 303-675-2175 or 800-344-3860 Toll Free USA/Canada  
**Fax:** 303-675-2176 or 800-344-3867 Toll Free USA/Canada  
**Email:** [orderlit@onsemi.com](mailto:orderlit@onsemi.com)

**N. American Technical Support:** 800-282-9855  
Toll Free USA/Canada  
**Europe, Middle East and Africa Technical Support:**  
Phone: 421 33 790 2910  
**Japan Customer Focus Center**  
Phone: 81-3-5773-3850

ON Semiconductor Website: [www.onsemi.com](http://www.onsemi.com)

Order Literature: <http://www.onsemi.com/orderlit>

For additional information, please contact your local Sales Representative