

## Features

- Low On-Resistance
- Low Gate Threshold Voltage
- Low Input Capacitance
- Fast Switching Speed
- **Lead Free/RoHS Compliant (Note 3)**
- **"Green" Device (Note 5 and 6)**



TOP VIEW

SOT-363

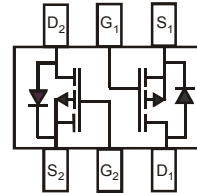
 TOP VIEW  
Internal Schematic

## Mechanical Data

- Case: SOT-363
- Case Material: Molded Plastic. "Green" Molding Compound. UL Flammability Classification Rating 94V-0
- Moisture Sensitivity: Level 1 per J-STD-020C
- Terminals: Solderable per MIL-STD-202, Method 208
- Lead Free Plating (Matte Tin Finish annealed over Alloy 42 leadframe).
- Terminal Connections: See Diagram
- Marking Information: See Page 3
- Ordering Information: See Page 3
- Weight: 0.006 grams (approximate)

## Maximum Ratings @ $T_A = 25^\circ\text{C}$ unless otherwise specified

Characteristic	Symbol	Value	Units
Drain-Source Voltage	$V_{DSS}$	-50	V
Drain-Gate Voltage (Note 1)	$V_{DGR}$	-50	V
Gate-Source Voltage	$V_{GSS}$	$\pm 20$	V
Drain Current (Note 2)	$I_D$	-130	mA

## Thermal Characteristics @ $T_A = 25^\circ\text{C}$ unless otherwise specified

Characteristic	Symbol	Value	Units
Total Power Dissipation (Note 2)	$P_d$	300	mW
Thermal Resistance, Junction to Ambient	$R_{\theta JA}$	417	$^\circ\text{C}/\text{W}$
Operating and Storage Temperature Range	$T_j, T_{STG}$	-55 to +150	$^\circ\text{C}$

## Electrical Characteristics @ $T_A = 25^\circ\text{C}$ unless otherwise specified

Characteristic	Symbol	Min	Typ	Max	Unit	Test Condition
<b>OFF CHARACTERISTICS (Note 4)</b>						
Drain-Source Breakdown Voltage	$BV_{DSS}$	-50	-75	—	V	$V_{GS} = 0\text{V}, I_D = -250\mu\text{A}$
Zero Gate Voltage Drain Current	$I_{DSS}$	—	—	-15	$\mu\text{A}$	$V_{DS} = -50\text{V}, V_{GS} = 0\text{V}, T_J = 25^\circ\text{C}$
		—	—	-60	$\mu\text{A}$	$V_{DS} = -50\text{V}, V_{GS} = 0\text{V}, T_J = 125^\circ\text{C}$
		—	—	-100	nA	$V_{DS} = -25\text{V}, V_{GS} = 0\text{V}, T_J = 25^\circ\text{C}$
Gate-Body Leakage	$I_{GSS}$	—	—	$\pm 10$	nA	$V_{GS} = \pm 20\text{V}, V_{DS} = 0\text{V}$
<b>ON CHARACTERISTICS (Note 4)</b>						
Gate Threshold Voltage	$V_{GS(th)}$	-0.8	-1.6	-2.0	V	$V_{DS} = V_{GS}, I_D = -1\text{mA}$
Static Drain-Source On-Resistance	$R_{DS(ON)}$	—	6	10	$\Omega$	$V_{GS} = -5\text{V}, I_D = -0.100\text{A}$
Forward Transconductance	$g_{FS}$	0.05	—	—	S	$V_{DS} = -25\text{V}, I_D = -0.1\text{A}$
<b>DYNAMIC CHARACTERISTICS</b>						
Input Capacitance	$C_{iss}$	—	—	45	pF	$V_{DS} = -25\text{V}, V_{GS} = 0\text{V}, f = 1.0\text{MHz}$
Output Capacitance	$C_{oss}$	—	—	25	pF	
Reverse Transfer Capacitance	$C_{rss}$	—	—	12	pF	
<b>SWITCHING CHARACTERISTICS</b>						
Turn-On Delay Time	$t_{D(ON)}$	—	10	—	ns	$V_{DD} = -30\text{V}, I_D = -0.27\text{A}, R_{GEN} = 50\Omega, V_{GS} = -10\text{V}$
Turn-Off Delay Time	$t_{D(OFF)}$	—	18	—	ns	

- Notes:
1.  $R_{GS} \leq 20\text{K}\Omega$ .
  2. Device mounted on FR-4 PCB, 1 inch x 0.85 inch x 0.062 inch; pad layout as shown on Diodes Inc. suggested pad layout document AP02001, which can be found on our website at <http://www.diodes.com/datasheets/ap02001.pdf>.
  3. No purposefully added lead.
  4. Short duration pulse test used to minimize self-heating effect.
  5. Diodes Inc.'s "Green" policy can be found on our website at [http://www.diodes.com/products/lead\\_free/index.php](http://www.diodes.com/products/lead_free/index.php).
  6. Product manufactured with Date Code UO (week 40, 2007) and newer are built with Green Molding Compound. Product manufactured prior to Date Code UO are built with Non-Green Molding Compound and may contain Halogens or Sb2O3 Fire Retardants.

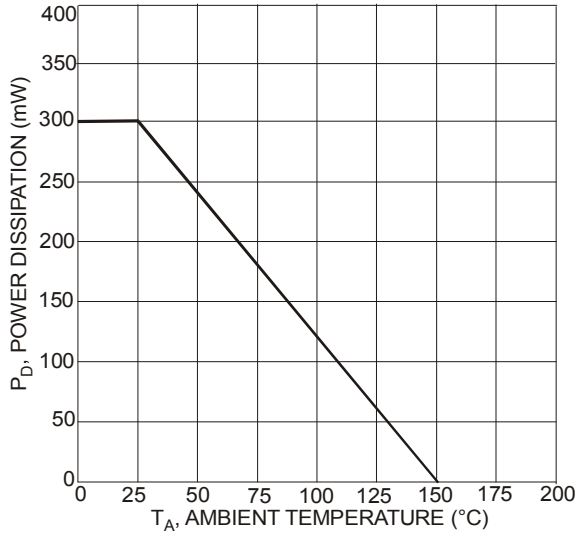

Fig. 1 Max Power Dissipation vs. Ambient Temperature

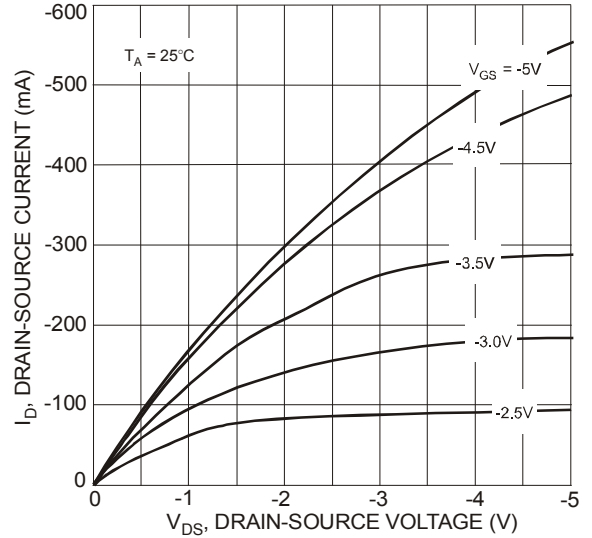

Fig. 2 Drain-Source Current vs. Drain-Source Voltage

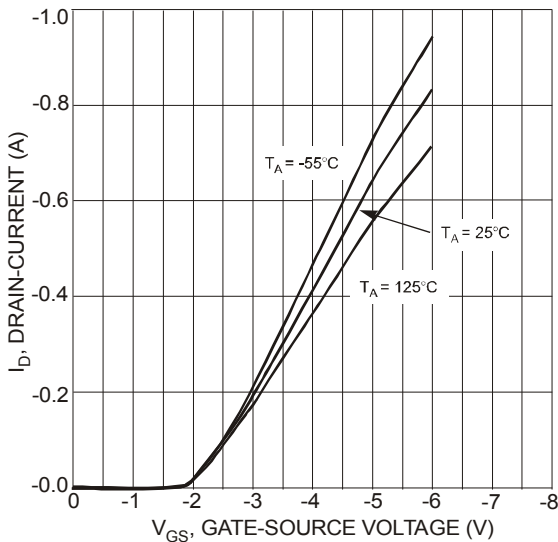

Fig. 3 Drain-Current vs. Gate-Source Voltage

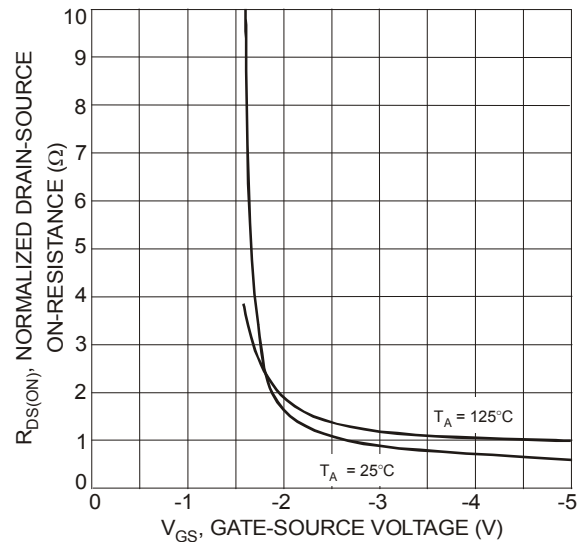

Fig. 4 On-Resistance vs. Gate-Source Voltage

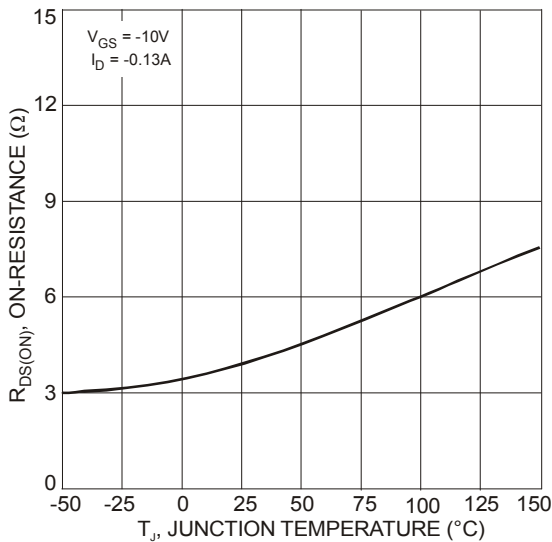

Fig. 5 On-Resistance vs. Junction Temperature

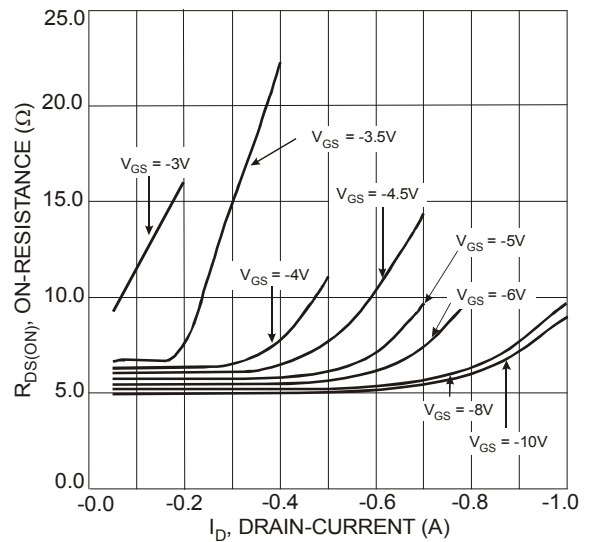

Fig. 6 On-Resistance vs. Drain-Current

**Ordering Information** (Note 7)

Part Number	Case	Packaging
BSS84DW-7-F	SOT-363	3000/Tape & Reel

Notes: 7. For packaging details, go to our website at <http://www.diodes.com/datasheets/ap02007.pdf>.

**Marking Information**

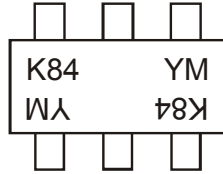

K84 = Product Type Marking Code  
 YM = Date Code Marking  
 Y = Year ex: N = 2002  
 M = Month ex: 9 = September

Date Code Key

Year	1998	1999	2000	2001	2002	2003	2004	2005	2006	2007	2008	2009	2010	2011	2012
Code	J	K	L	M	N	P	R	S	T	U	V	W	X	Y	Z

Month	Jan	Feb	Mar	Apr	May	Jun	Jul	Aug	Sep	Oct	Nov	Dec
Code	1	2	3	4	5	6	7	8	9	O	N	D

**Package Outline Dimensions**

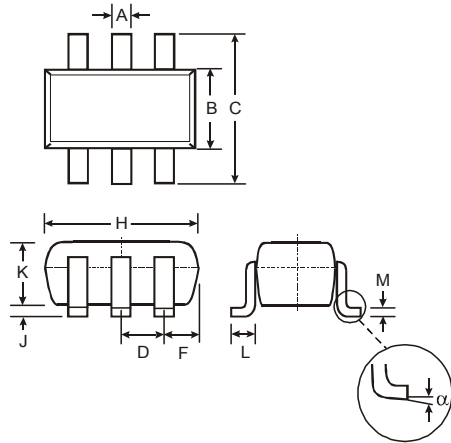

SOT-363		
Dim	Min	Max
A	0.10	0.30
B	1.15	1.35
C	2.00	2.20
D	0.65 Nominal	
F	0.30	0.40
H	1.80	2.20
J	—	0.10
K	0.90	1.00
L	0.25	0.40
M	0.10	0.25
α	0°	8°
All Dimensions in mm		

**Suggested Pad Layout**

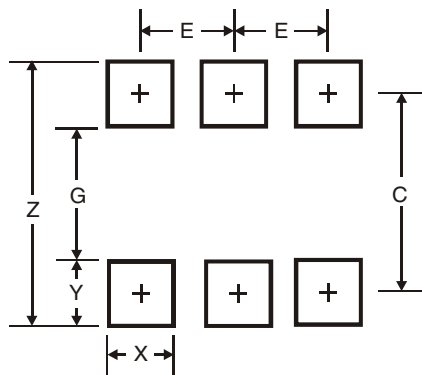

Dimensions	Value (in mm)
Z	2.5
G	1.3
X	0.42
Y	0.6
C	1.9
E	0.65

**IMPORTANT NOTICE**

Diodes Incorporated and its subsidiaries reserve the right to make modifications, enhancements, improvements, corrections or other changes without further notice to any product herein. Diodes Incorporated does not assume any liability arising out of the application or use of any product described herein; neither does it convey any license under its patent rights, nor the rights of others. The user of products in such applications shall assume all risks of such use and will agree to hold Diodes Incorporated and all the companies whose products are represented on our website, harmless against all damages.

**LIFE SUPPORT**

Diodes Incorporated products are not authorized for use as critical components in life support devices or systems without the expressed written approval of the President of Diodes Incorporated.