

PLEASE CHECK WWW.MOLEX.COM FOR LATEST PART INFORMATION

Part Number: [0675810011](#)
Status: **Active**
Overview: [serial_ata_products](#)
Description: 1.27mm (.050") Pitch Serial ATA Crimp Terminal for Power Cable Receptacle, 0.76µm (30µ") Gold (Au) Plating, with Reel Direction - Type 2, Lead free

Documents:

[3D Model](#) [Product Specification PS-67490-002 \(PDF\)](#)
[Drawing \(PDF\)](#) [RoHS Certificate of Compliance \(PDF\)](#)

General

Product Family Crimp Terminals
 Series [67581](#)
 Crimp Quality Equipment Yes
 Overview [serial_ata_products](#)
 Product Name Serial ATA

Physical

Durability (mating cycles max) 50
 Gender Female
 Material - Metal Phosphor Bronze
 Material - Plating Mating Gold
 Material - Plating Termination Tin
 Packaging Type Reel
 Plating min: Mating (µin) 30
 Plating min: Mating (µm) 0.76
 Plating min: Termination (µin) 73.82
 Plating min: Termination (µm) 1.85
 Termination Interface: Style Crimp or Compression
 Wire Insulation Diameter 2.20-1.60mm(0.087-0.063)
 Wire Size AWG 18, 20, 22
 Wire Size mm² 3.79-2.00

Electrical

Current - Maximum per Contact 1.5A
 Voltage - Maximum 15V DC

Solder Process Data

Lead-free Process Capability Wave Capable (TH only)

Material Info

Reference - Drawing Numbers

Packaging Specification PK-67581-001
 Product Specification PS-67490-002
 Sales Drawing SD-67581-001

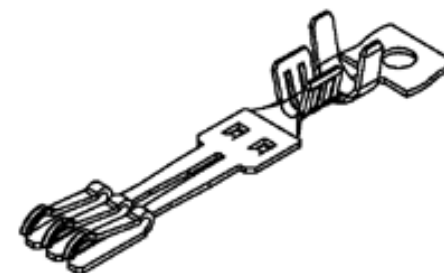

Series

image - Reference only

EU RoHS

**ELV and RoHS
 Compliant**
**REACH SVHC
 Contains SVHC: No**
**Halogen-Free
 Status**

China RoHS



**Need more information on product
 environmental compliance?**

Email productcompliance@molex.com
 For a multiple part number RoHS Certificate of Compliance, [click here](#)

Please visit the [Contact Us](#) section for any non-product compliance questions.

Search Parts in this Series

[67581Series](#)

Use With

[67582 Crimp Housing](#)

Application Tooling | FAQ

Tooling specifications and manuals are found by selecting the products below. Crimp Height Specifications are then contained in the Application Tooling Specification document.

Global

Description	Product #
T2 Terminator Die	0638561000
FineAdjust™ Applicator	0638661000

10 9 8 7 6 5 4 3 2 1

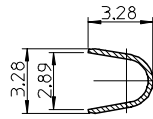
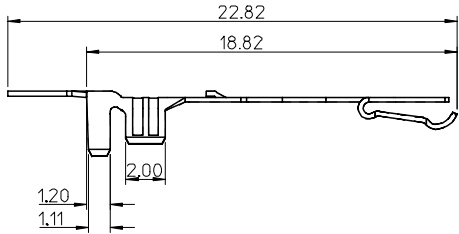

Section I-I

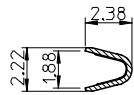

Section C-C

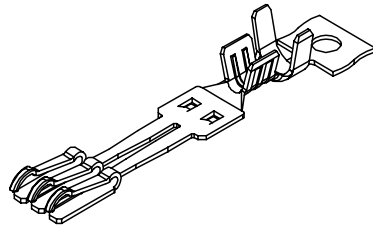
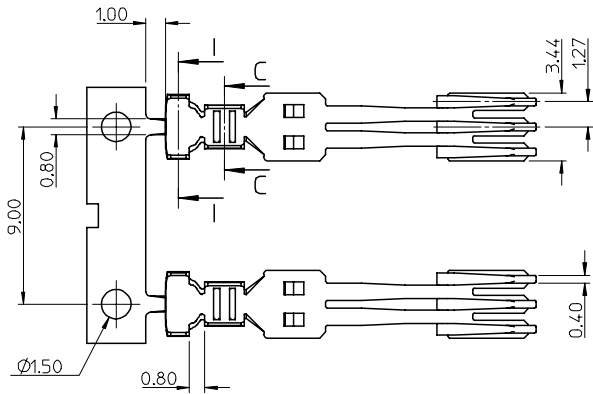

NOTES:

- MATERIAL :
PHOSPHOR BRONZE, THICKNESS = 0.25mm
- PLATING :
CONTACT AREA: (A) GOLD FLASH
(B) GOLD PLATED 0.76 MICRON.
(C) GOLD PLATED 0.38 MICRON.
CRIMPING AREA: TIN PLATED 1.875 MICRON MINIMUM.
UNDER PLATE: NICKELPLATED 1.25 MICRON MINIMUM.
- TO BE USED WITH 67582, 5 SETS TERMINAL PER HOUSING
- PRODUCT SPECIFICATION REFER TO PS-67490-002
- PACKAGE SPECIFICATION REFER TO PK-67581-001
- CRIMPING SPECIFICATION REFER TO CS-67581-001
- RECOMMEND WIRE SIZE: 18/20/22AWG
- PRODUCT COMPLIANT TO RoHS DIRECTIVE 2002/95/EC AND ELV DIRECTIVE 2000/53/EC.

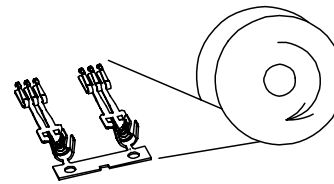

BEFORE CRIMPING
TYPE I

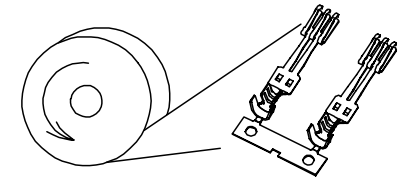

BEFORE CRIMPING
TYPE II

P/N	CONTACT AREA GOLD PLATING	TYPE
67581-0000	GOLD FLASH	TYPE I
67581-0001	0.76 MICRON GOLD PLATING	
67581-0002	0.38 MICRON GOLD PLATING	
67581-0010	GOLD FLASH	TYPE II
67581-0011	0.76 MICRON GOLD PLATING	
67581-0012	0.38 MICRON GOLD PLATING	

NEW RELEASE EC NO: SH2007-0312 DRWN: BCHENZ6 CHKD: JTIAN APPR: JNCHEN	QUALITY SYMBOLS ▽=0 ▽=0	GENERAL TOLERANCES (UNLESS SPECIFIED)		DIMENSION STYLE MM ONLY		SCALE 4:1	DESIGN UNITS METRIC	THIRD ANGLE PROJECTION			
				DRAWN BY	DATE	TITLE					
				4 PLACES	± ---	± ---	GRATE MA	2003/08/15	TERMINAL FOR SATA POWER CABLE RECEPTACLE		
				3 PLACES	± ---	± ---	CHECKED BY	DATE			
		2 PLACES	± 0.25	± .010	YA JUN	2003/08/15					
		1 PLACE	± 0.25	± .010	APPROVED BY	DATE					
		ANGULAR ± 3 °			SAM	2003/08/15					
		DRAFT WHERE APPLICABLE MUST REMAIN WITHIN DIMENSIONS		MATERIAL NO.		DOCUMENT NO.		SHEET NO.			
				SEE TABLE		SD-67581-001		1 OF 1			
		THIS DRAWING CONTAINS INFORMATION THAT IS PROPRIETARY TO MOLEX INCORPORATED AND SHOULD NOT BE USED WITHOUT WRITTEN PERMISSION									

9 8 7 6 5 4 3 2 1