

PLEASE CHECK WWW.MOLEX.COM FOR LATEST PART INFORMATION

Part Number: [0197114005](#)
Status: **Active**
Description: PCB Tab Right Angle Quick Disconnect, Male, for Wire, Box, Tab 6.35mm (.250") x 0.81mm (.032")

Documents:

[Drawing \(PDF\)](#) [RoHS Certificate of Compliance \(PDF\)](#)

Agency Certification

UL E79133

General

Product Family Quick Disconnects
 Series [19711](#)
 Crimp Quality Equipment Yes
 Product Name PCB Tab
 Type Quick Disconnect

Physical

Barrel Type N/A
 Gender Male
 Glow-Wire Compliant No
 Insulation None
 Lock to Mating Part None
 Material - Metal Brass
 Orientation PCB Flag Tab
 Packaging Type Bag
 Polarized to Mating Part No
 Tab Thickness 0.81mm (.032")
 Tab Width 6.35mm (.250")
 Wire Insulation Diameter N/A
 Wire Size AWG N/A

Electrical

Voltage - Maximum N/A

Material Info

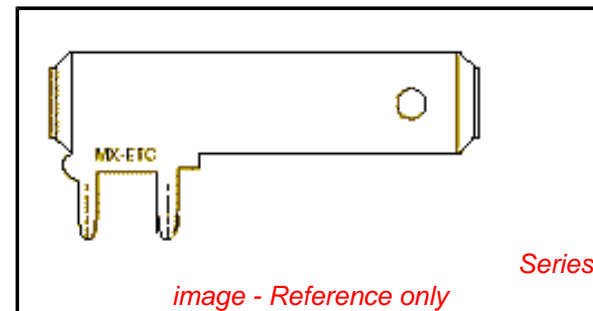

EU RoHS

**ELV and RoHS
Compliant**

REACH SVHC

Not Reviewed

Halogen-Free

Status

Not Reviewed

China RoHS



**Need more information on product
environmental compliance?**

Email productcompliance@molex.com
 For a multiple part number RoHS Certificate of
 Compliance, [click here](#)

Please visit the [Contact Us](#) section for any
 non-product compliance questions.

Search Parts in this Series

[19711Series](#)

MATERIAL NUMBER	ENGINEERING NUMBER	CUSTOMER NUMBER	CARRIER	PLATING SEE NOTE 6 & 7.	DIMENSION "A"	DIMENSION "B"	HOLE
197114001	19711-4001	-	LOOSE	TIN/LEAD	.300	.250	YES
197114003	19711-4003	-	STRIP	TIN/LEAD	.300	.250	YES
197114005	19711-4005	-	LOOSE	TIN/LEAD	.300	.250	OMIT
197114007	19711-4007	-	STRIP	TIN/LEAD	.300	.250	OMIT

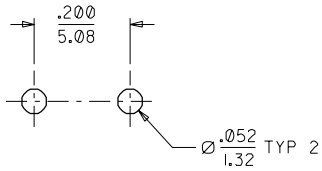
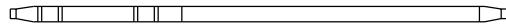
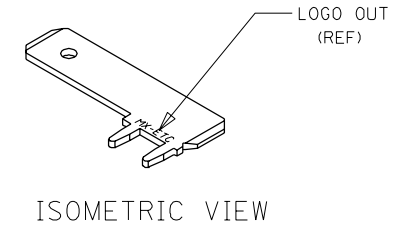
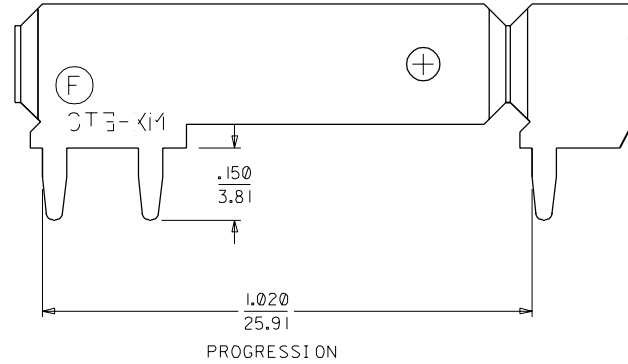
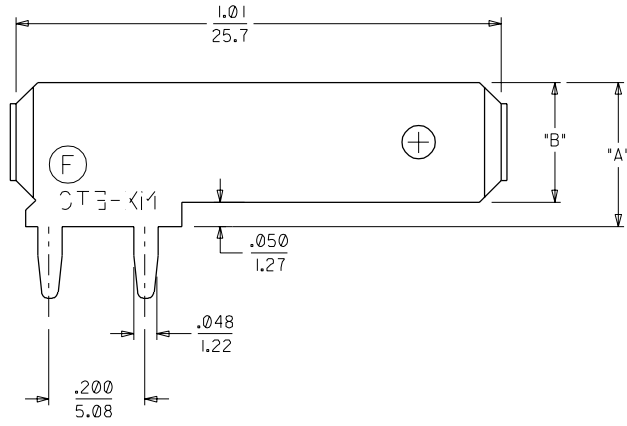

RECOMMENDED P.W.B.
HOLE LAYOUT

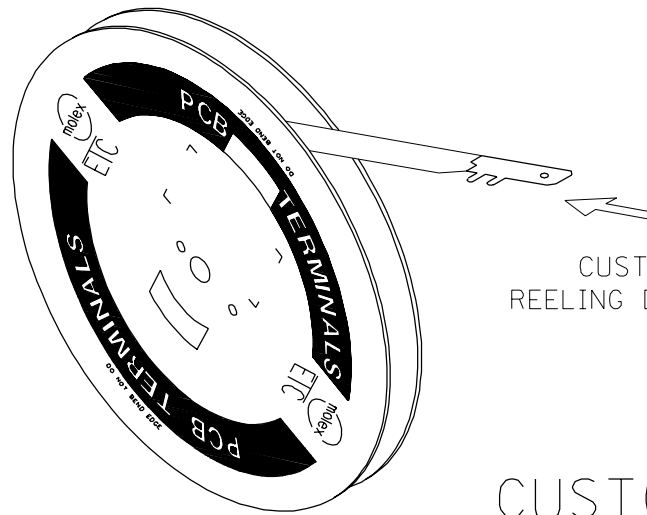

CUSTOMER DRAWING

- NOTES:
1. BARE EDGES PERMISSIBLE AT CARRIER CUT OFF.
 2. MATERIAL: BRASS.
 3. MATERIAL THICKNESS: $.032 \pm .001 / (\varnothing.813 \pm 0.03)$
 4. TAB CONFORMS TO NEMA SPECIFICATIONS.
 5. ALL DIMENSIONS AND NOTES ARE REFERENCE ONLY UNLESS NOTED.
 6. PLATING: THICKNESS: $90/10$ TIN/LEAD: $150 \mu \text{in} (3.81 \mu\text{m})$ MIN THICKNESS.
 7. FINISH: MATTE

MOVED LOGO FARSD EC NO. ETC2002-0182 DRAWING: 01/12/12 CHK: HEB 01/12/12 APPR: RWD 01/12/12	QUALITY SYMBOLS MAJOR $\nabla = 0$ CRITICAL $\nabla = 0$	GENERAL TOLERANCES: (UNLESS SPECIFIED)		SCALE 5:1	DESIGN UNITS <input type="checkbox"/> mm <input checked="" type="checkbox"/> INCH	DIMENSIONS: <input type="checkbox"/> mm <input checked="" type="checkbox"/> INCH <input type="checkbox"/> mm ONLY	SHT REV	
		4 PLACES $\pm 0.$ $\pm .$ 3 PLACES $\pm 0.$ $\pm .005$ 2 PLACES ± 0.13 $\pm .01$ 1 PLACE ± 0.25 $\pm .$	DRAWN BY & DATE JH 98/04/28 CHECKED BY & DATE RWD 98/04/28 APPROVED BY & DATE RWD 98/04/28	TITLE: QUICK DISCONNECT PCB MOUNTABLE .250 X .032 TAB		MOLEX INCORPORATED		MATERIAL NO. SEE CHART
F	REV	DRAFT WHERE APPLICABLE MUST REMAIN WITHIN DIMENSIONS		THIS DRAWING CONTAINS INFORMATION THAT IS PROPRIETARY TO MOLEX INCORPORATED AND SHOULD NOT BE USED WITHOUT WRITTEN PERMISSION.				SIZE C