



# PD55025-E PD55025S-E

RF POWER transistor, LdmoST plastic family  
N-channel enhancement-mode, lateral MOSFETs

## Features

- Excellent thermal stability
- Common source configuration
- $P_{OUT} = 25\text{ W}$  with 14.5dB gain @ 500 MHz / 12.5 V
- New RF plastic package

## Description

The device is a common source N-channel, enhancement-mode lateral field-effect RF power transistor. It is designed for high gain, broad band commercial and industrial applications. It operates at 12 V in common source mode at frequencies up to 1 GHz. The device boasts the excellent gain, linearity and reliability of ST's latest LDMOS technology mounted in the first true SMD plastic RF power package, PowerSO-10RF. The device's superior linearity performance makes it an ideal solution for car mobile radio. The PowerSO-10 plastic package, designed to offer high reliability, is the first ST JEDEC approved, high power SMD package. It has been specially optimized for RF needs and offers excellent RF performance and ease of assembly. Mounting recommendations are available in [www.st.com/rf/](http://www.st.com/rf/) (look for application note AN1294).



Figure 1. Pin connection



Table 1. Device summary

Order code	Package	Packing
PD55025-E	PowerSO-10RF (formed lead)	Tube
PD55025S-E	PowerSO-10RF (straight lead)	Tube
PD55015TR-E	PowerSO-10RF (formed lead)	Tape and reel
PD55015STR-E	PowerSO-10RF (straight lead)	Tape and reel

# Contents

<b>1</b>	<b>Electrical data</b> .....	<b>3</b>
1.1	Maximum ratings .....	3
1.2	Thermal data .....	3
<b>2</b>	<b>Electrical characteristics</b> .....	<b>4</b>
2.1	Static .....	4
2.2	Dynamic .....	4
2.3	Moisture sensitivity level .....	4
<b>3</b>	<b>Impedance</b> .....	<b>5</b>
<b>4</b>	<b>Typical performance</b> .....	<b>6</b>
<b>5</b>	<b>Test circuit</b> .....	<b>11</b>
<b>6</b>	<b>Circuit layout</b> .....	<b>12</b>
<b>7</b>	<b>Common source s-parameter</b> .....	<b>14</b>
<b>8</b>	<b>Package mechanical data</b> .....	<b>17</b>
<b>9</b>	<b>Revision history</b> .....	<b>22</b>

# 1 Electrical data

## 1.1 Maximum ratings

**Table 2. Absolute maximum ratings ( $T_{CASE} = 25^{\circ}C$ )**

Symbol	Parameter	Value	Unit
$V_{(BR)DSS}$	Drain-source voltage	40	V
$V_{GS}$	Gate-source voltage	$\pm 20$	V
$I_D$	Drain current	7	A
$P_{DISS}$	Power dissipation (@ $T_C = 70^{\circ}C$ )	79	W
$T_J$	Max. operating junction temperature	165	$^{\circ}C$
$T_{STG}$	Storage temperature	-65 to +150	$^{\circ}C$

## 1.2 Thermal data

**Table 3. Thermal data**

Symbol	Parameter	Value	Unit
$R_{thJC}$	Junction - case thermal resistance	1.2	$^{\circ}C/W$

## 2 Electrical characteristics

$T_{CASE} = +25\text{ }^{\circ}\text{C}$

### 2.1 Static

**Table 4. Static**

Symbol	Test conditions		Min.	Typ.	Max.	Unit
$I_{DSS}$	$V_{GS} = 0$	$V_{DS} = 28\text{ V}$			1	$\mu\text{A}$
$I_{GSS}$	$V_{GS} = 20\text{ V}$	$V_{DS} = 0$			1	$\mu\text{A}$
$V_{GS(Q)}$	$V_{DS} = 28\text{ V}$	$I_D = 100\text{ mA}$	2.0		5.0	V
$V_{DS(ON)}$	$V_{GS} = 10\text{ V}$	$I_D = 3\text{ A}$		0.7	0.8	V
$G_{FS}$	$V_{DS} = 10\text{ V}$	$I_D = 3\text{ A}$	2.5			mho
$C_{ISS}$	$V_{GS} = 0$	$V_{DS} = 12.5\text{ V}$		86		pF
$C_{OSS}$	$V_{GS} = 0$	$V_{DS} = 12.5\text{ V}$		76		pF
$C_{RSS}$	$V_{GS} = 0$	$V_{DS} = 12.5\text{ V}$		5.8		pF

### 2.2 Dynamic

**Table 5. Dynamic**

Symbol	Test conditions		Min.	Typ.	Max.	Unit
$P_{OUT}$	$V_{DD} = 12.5\text{ V}$ , $I_{DQ} = 200\text{ mA}$	$f = 500\text{ MHz}$	25			W
$G_P$	$V_{DD} = 12.5\text{ V}$ , $I_{DQ} = 200\text{ mA}$ , $P_{OUT} = 25\text{ W}$ , $f = 500\text{ MHz}$			14.5		dB
$h_D$	$V_{DD} = 12.5\text{ V}$ , $I_{DQ} = 200\text{ mA}$ , $P_{OUT} = 25\text{ W}$ , $f = 500\text{ MHz}$			50		%
Load mismatch	$V_{DD} = 15.5\text{ V}$ , $I_{DQ} = 200\text{ mA}$ , $P_{OUT} = 25\text{ W}$ , $f = 500\text{ MHz}$ All phase angles		20:1			VSWR

### 2.3 Moisture sensitivity level

**Table 6. Moisture sensitivity level**

Test methodology	Rating
J-STD-020B	MSL 3

### 3 Impedance

Figure 2. Current conventions



Table 7. Impedance data

Freq. (MHz)	$Z_{IN} (\Omega)$	$Z_{DL}(\Omega)$
175	$3.20 - j 4.41$	$1.56 + j 2.14$
480	$1.01 - j 1.67$	$1.06 + j 0.22$
500	$0.93 - j 1.53$	$1.12 + j 0.20$
520	$0.88 - j 1.98$	$1.07 + j 0.83$

# 4 Typical performance

**Figure 3. Capacitance vs supply voltage**



**Figure 4. Drain current vs gate source voltage**



**Figure 5. Gate-source voltage vs case temperature**



**Figure 6. Output power vs input power**



Figure 7. Output power vs input power

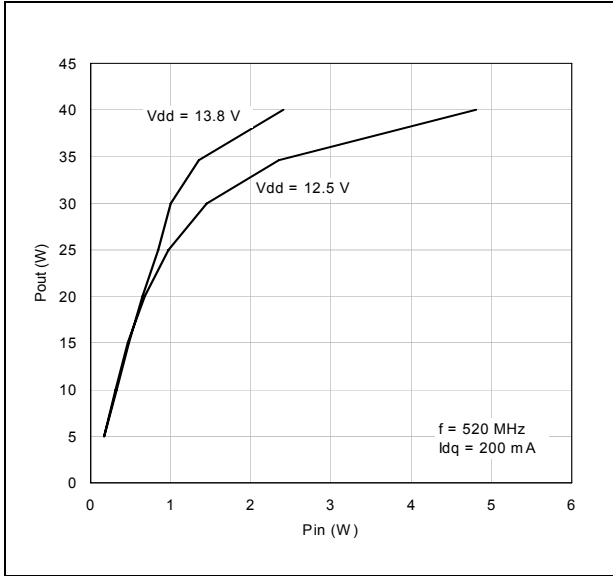

Figure 8. Power gain vs. output power

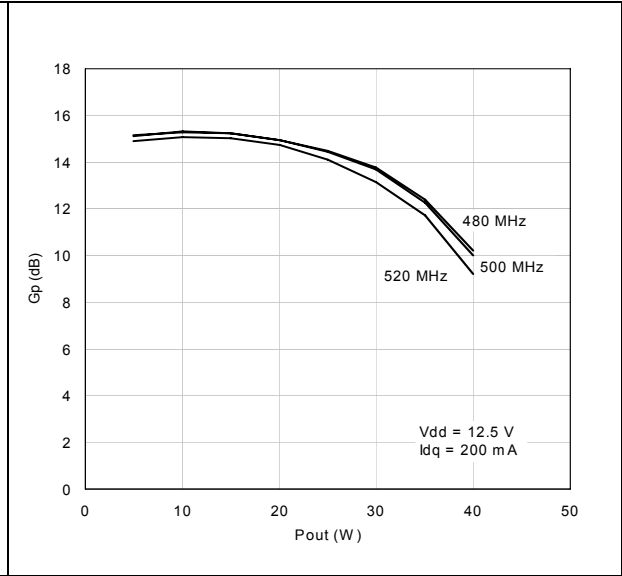

Figure 9. Drain efficiency vs output power

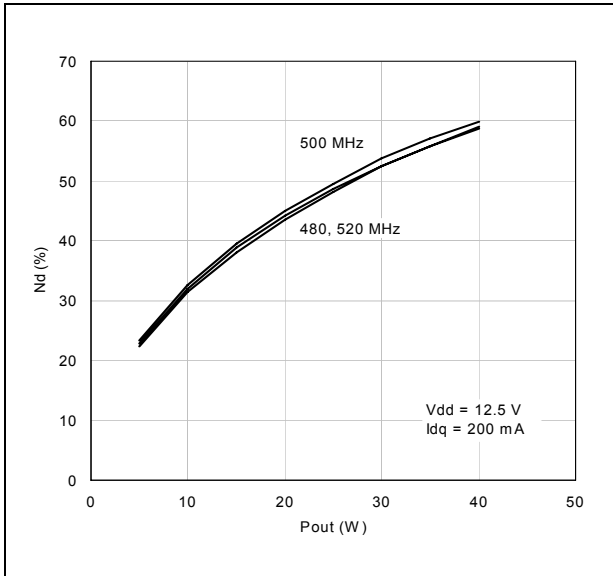

Figure 10. Input return loss vs output power

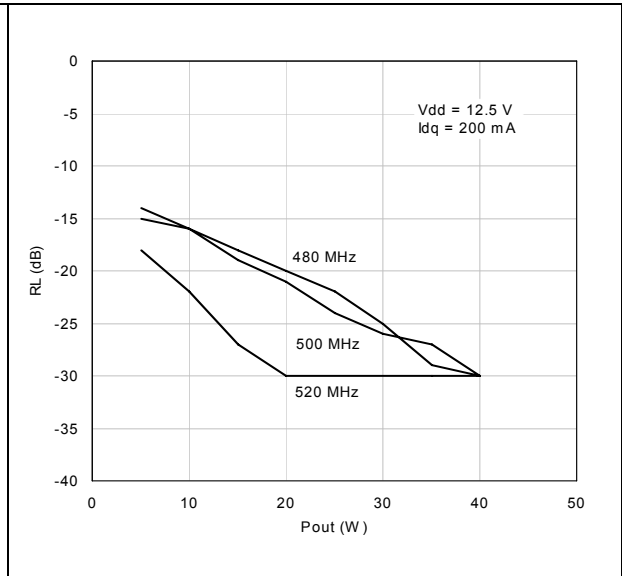

Figure 11. Output power vs bias current



Figure 12. Drain efficiency vs bias current



Figure 13. Output power vs supply voltage

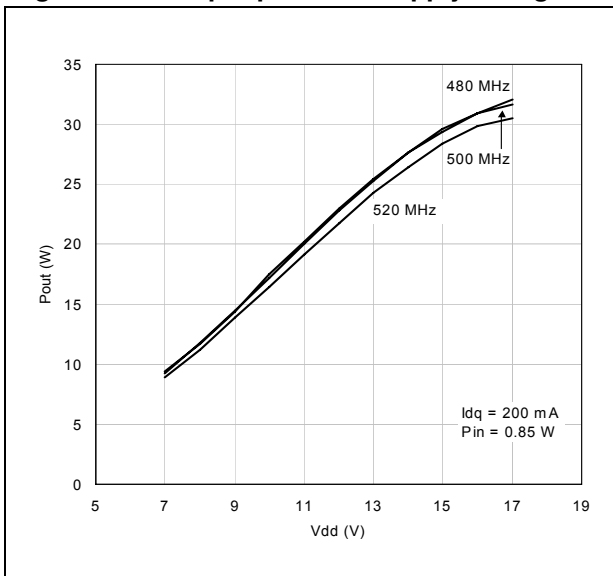

Figure 14. Drain efficiency vs supply voltage

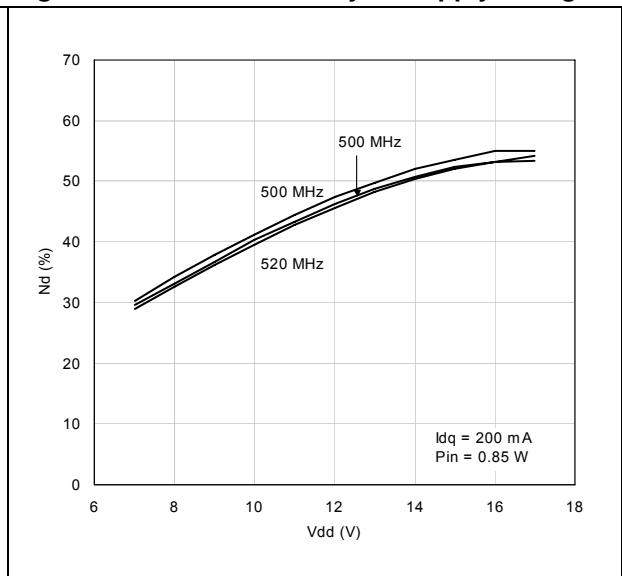



Figure 15. Output power vs gate bias voltage

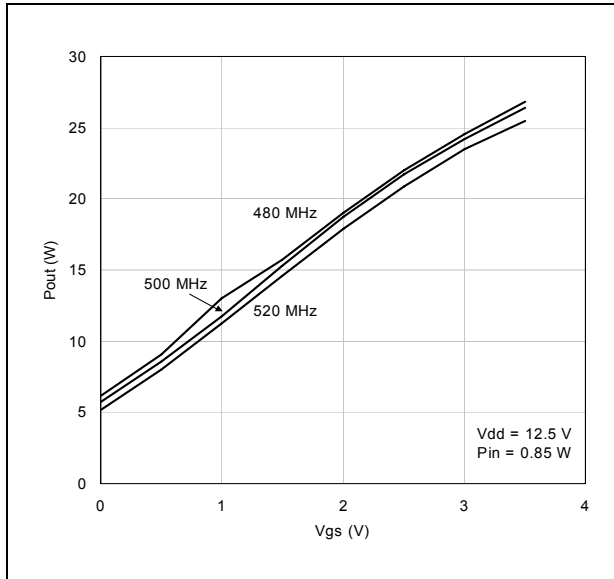

Figure 16. Output power vs input power (f = 175 MHz)

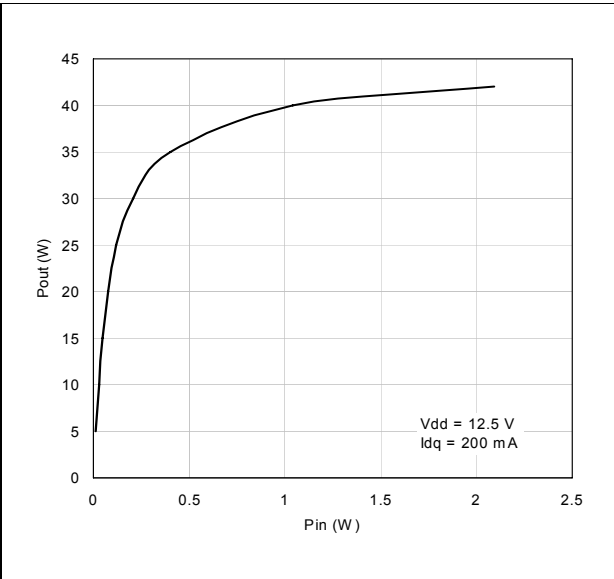

Figure 17. Power gain vs output power (f = 175 MHz)

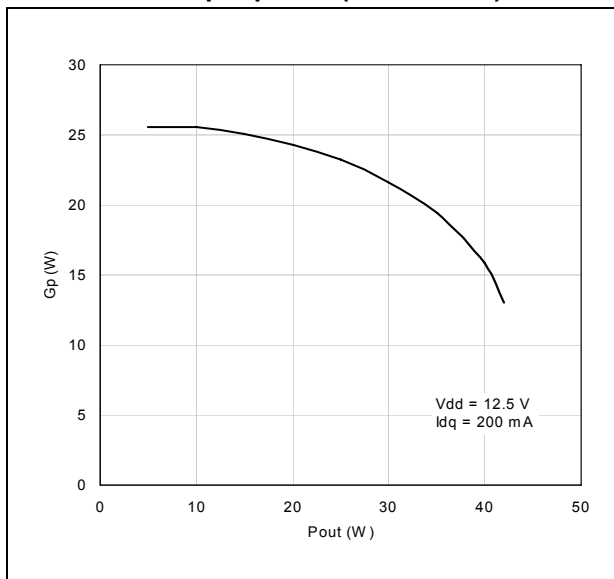

Figure 18. Drain efficiency vs output power (f = 175 MHz)

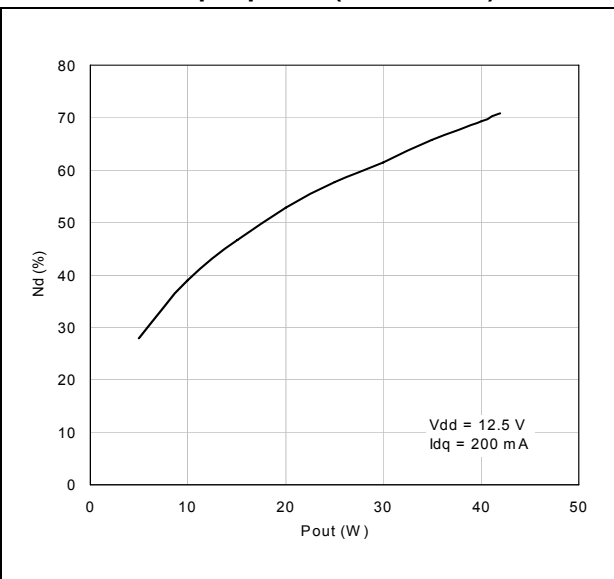
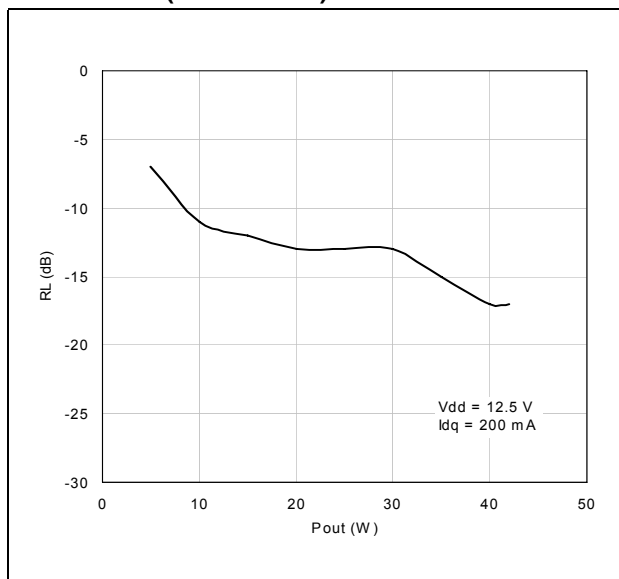

Figure 19. Input return loss vs output power  
(f = 175 MHz)



## 5 Test circuit

Figure 20. 500 MHz test circuit schematic (engineering)



Table 8. Test circuit component part list

Component	Description
B1,B2	Ferrite bead
C1,C13	300 pF, 100 mil chip capacitor
C2,C3,C4,C12,C13,C14	1 to 20 pF trimmer capacitor
C6	39 pF ATC 100B surface mount ceramic chip capacitor
C7, C19	120 pF 100 mil chip capacitor
C10, C16	10 $\mu$ F, 50 V electrolytic capacitor
C9, C17	0.1 mF, 100 mil chip cap
C8, C18	1.000 pF 100 mil chip cap
C5, C11	33 pF, 100 mil chip cap
L1	56 nH, 7 TURN, Coilcraft
N1, N2	Type N flange mount
R1	15 $\Omega$ , 1 W chip resistor
R2	1 k $\Omega$ , 1 W chip resistor
R3	33 k $\Omega$ , 1 W chip resistor
Z1	0.471" X 0.080" microstrip
Z2	1.082" X 0.080" microstrip
Z3	0.372" X 0.080" microstrip
Z4,Z5	0.260" X 0.223" microstrip
Z6	0.050" X 0.080" microstrip
Z7	0.551" X 0.080" microstrip
Z8	0.825" X 0.080" microstrip
Z9	0.489" X 0.080" microstrip
Board	Roger, ultra lam 2000 THK 0.030", $\epsilon_r = 2.55$ 2oz. ED cu 2 Sides.

## 6 Circuit layout

Figure 21. 500 MHz test circuit

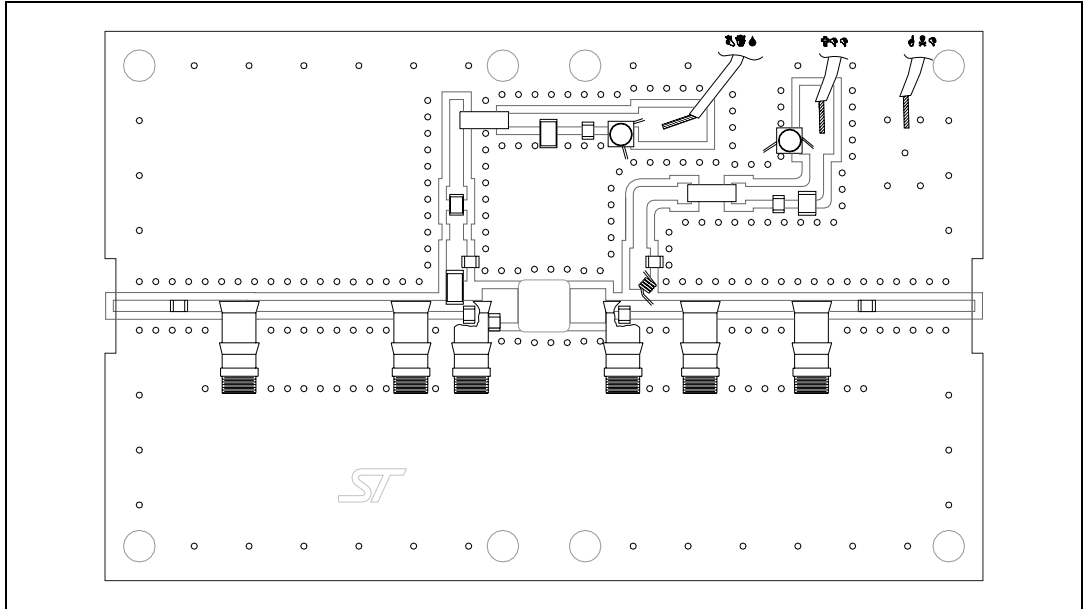
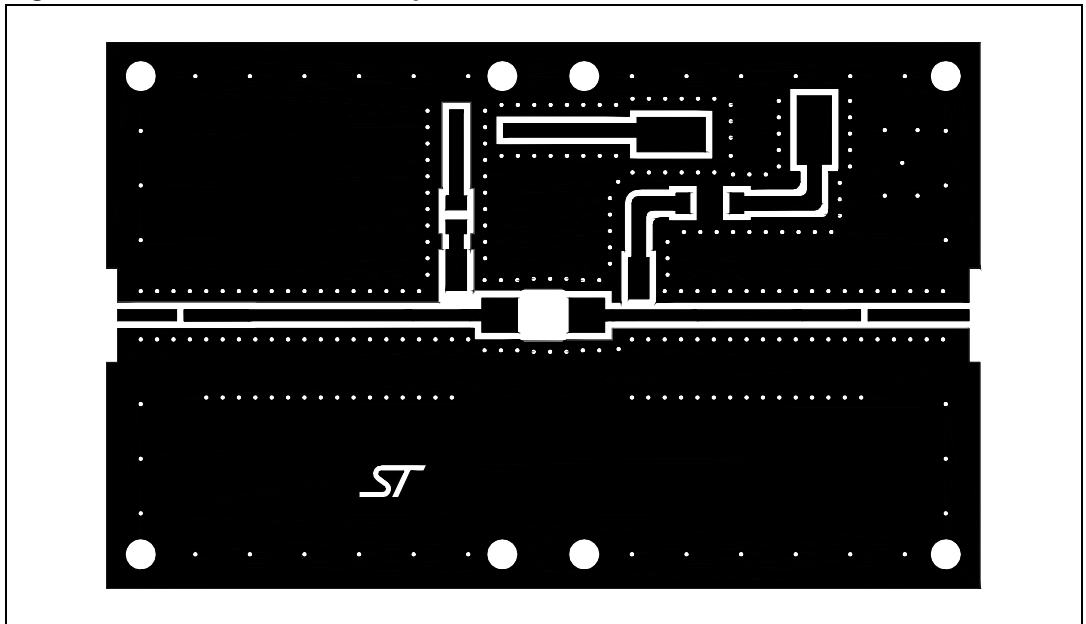

Figure 22. 500 MHz test circuit photomaster





## 7 Common source s-parameter

**Table 10. S-parameter for PD55025S-E ( $V_{DS} = 12.5\text{ V}$   $I_D = 500\text{ mA}$ )**

Freq (MHz)	$ S_{11} $	$\angle S_{11}$	$ S_{21} $	$\angle S_{21}$	$ S_{12} $	$\angle S_{12}$	$ S_{22} $	$\angle S_{22}$
50	0.837	-162	13.33	89	0.018	-1	0.780	-168
100	0.846	-169	6.51	76	0.017	-12	0.803	-172
150	0.862	-171	4.15	66	0.016	-19	0.831	-172
200	0.878	-173	2.93	58	0.015	-26	0.859	-172
250	0.895	-174	2.20	51	0.013	-31	0.874	-172
300	0.910	-174	1.71	45	0.012	-36	0.886	-173
350	0.921	-175	1.36	40	0.010	-40	0.892	-173
400	0.932	-176	1.11	35	0.009	-42	0.897	-175
450	0.941	-177	0.92	31	0.008	-43	0.915	-176
500	0.946	-178	0.78	27	0.007	-44	0.932	-177
550	0.953	-178	0.66	24	0.006	-43	0.946	-178
600	0.957	-179	0.57	21	0.005	-42	0.964	-179
650	0.960	-180	0.50	18	0.004	-39	0.975	-178
700	0.964	180	0.44	16	0.004	-34	0.976	-179
750	0.966	179	0.39	14	0.003	-29	0.981	-179
800	0.968	178	0.35	12	0.002	-15	0.979	-179
850	0.970	178	0.31	10	0.002	-2	0.964	-179
900	0.971	177	0.28	8	0.002	16	0.960	180
950	0.972	177	0.26	6	0.002	34	0.953	179
1000	0.972	176	0.23	5	0.003	45	0.940	178

**Table 11. S-parameter PD55025S-E ( $V_{DS} = 12.5\text{ V}$   $I_D = 1.5\text{ A}$ )**

Freq (MHz)	$ S_{11} $	$\angle S_{11}$	$ S_{21} $	$\angle S_{21}$	$ S_{12} $	$\angle S_{12}$	$ S_{22} $	$\angle S_{22}$
50	0.876	-164	13.87	90	0.013	1	0.823	-172
100	0.880	-172	6.87	79	0.012	-7	0.838	-175
150	0.887	-174	4.46	71	0.012	-13	0.855	-176
200	0.895	-175	3.22	64	0.011	-18	0.873	-175
250	0.905	-176	2.47	58	0.010	-22	0.879	-175
300	0.915	-176	1.96	52	0.009	-25	0.885	-175
350	0.922	-177	1.60	47	0.009	-28	0.886	-175

Table 11. S-parameter PD55025S-E ( $V_{DS} = 12.5\text{ V}$   $I_D = 1.5\text{ A}$ ) (continued)

Freq (MHz)	$ S_{11} $	$\angle S_{11}$	$ S_{21} $	$\angle S_{21}$	$ S_{12} $	$\angle S_{12}$	$ S_{22} $	$\angle S_{22}$
400	0.931	-178	1.32	42	0.008	-30	0.889	-177
450	0.938	-178	1.11	38	0.007	-31	0.906	-178
500	0.942	-179	0.95	34	0.006	-31	0.923	-179
550	0.948	-179	0.82	31	0.005	-30	0.937	-179
600	0.952	-180	0.71	28	0.005	-27	0.956	-179
650	0.954	180	0.63	25	0.004	-22	0.967	-179
700	0.959	179	0.55	22	0.003	-16	0.969	-179
750	0.961	178	0.49	20	0.003	-6	0.973	-179
800	0.963	178	0.45	17	0.003	3	0.970	-179
850	0.966	177	0.40	15	0.003	17	0.956	-180
900	0.967	177	0.36	13	0.003	27	0.952	179
950	0.968	176	0.33	11	0.003	38	0.945	179
1000	0.968	176	0.30	9	0.003	45	0.933	177

Table 12. S-parameter for PD55025S-E ( $V_{DS} = 12.5\text{ V}$   $I_D = 3\text{ A}$ )

Freq (MHz)	$ S_{11} $	$\angle S_{11}$	$ S_{21} $	$\angle S_{21}$	$ S_{12} $	$\angle S_{12}$	$ S_{22} $	$\angle S_{22}$
50	0.890	-165	13.19	91	0.012	2	0.837	-174
100	0.892	-172	6.55	81	0.011	-6	0.846	-176
150	0.898	-174	4.28	73	0.011	-12	0.865	-176
200	0.904	-175	3.11	66	0.010	-15	0.879	-176
250	0.913	-176	2.39	60	0.010	-20	0.883	-176
300	0.921	-177	1.91	54	0.009	-23	0.089	-176
350	0.926	-177	1.57	49	0.008	-25	0.887	-176
400	0.935	-178	1.31	44	0.007	-27	0.889	-177
450	0.941	-179	1.10	40	0.007	-28	0.905	-179
500	0.944	-179	0.94	36	0.006	-27	0.921	-179
550	0.949	-180	0.82	33	0.005	-25	0.936	-180
600	0.953	180	0.71	29	0.004	-21	0.954	180
650	0.955	179	0.63	26	0.004	-17	0.964	-180
700	0.959	179	0.56	24	0.003	-10	0.965	-180
750	0.961	178	0.50	21	0.003	-2	0.968	-180
800	0.963	177	0.45	19	0.003	10	0.966	-179
850	0.966	177	0.41	17	0.003	22	0.952	-180

Table 12. S-parameter for PD55025S-E ( $V_{DS} = 12.5 \text{ V}$   $I_D = 3 \text{ A}$ ) (continued)

Freq (MHz)	$ S_{11} $	$S_{11} < \Phi$	$ S_{21} $	$S_{21} < \Phi$	$ S_{12} $	$S_{12} < \Phi$	$ S_{22} $	$S_{22} < \Phi$
900	0.967	176	0.37	15	0.003	32	0.948	180
950	0.968	176	0.34	15	0.003	41	0.942	179
1000	0.969	175	0.31	11	0.004	49	0.930	177

Table 13. S-parameter for PD55025S-E ( $V_{DS} = 13.8 \text{ V}$   $I_D = 3 \text{ A}$ )

Freq (MHz)	$ S_{11} $	$S_{11} < \Phi$	$ S_{21} $	$S_{21} < \Phi$	$ S_{12} $	$S_{12} < \Phi$	$ S_{22} $	$S_{22} < \Phi$
50	0.849	-164	13.99	91	0.012	2	0.833	-173
100	0.881	-171	6.94	80	0.011	-6	0.841	-175
150	0.895	-173	4.51	72	0.011	-12	0.857	-175
200	0.903	-175	3.27	65	0.010	-16	0.871	-175
250	0.912	-176	2.50	58	0.010	-21	0.877	-175
300	0.921	-176	1.99	52	0.009	-24	0.882	-175
350	0.927	-177	1.62	47	0.008	-27	0.883	-176
400	0.936	-178	1.35	42	0.007	-29	0.886	-177
450	0.943	-178	1.13	38	0.006	-29	0.904	-178
500	0.946	-179	0.97	34	0.006	-29	0.920	-179
550	0.952	-180	0.83	31	0.005	-26	0.935	-179
600	0.955	180	0.72	27	0.004	-23	0.955	-180
650	0.957	179	0.64	24	0.004	-17	0.965	-179
700	0.961	179	0.56	22	0.003	-8	0.967	-179
750	0.963	178	0.50	19	0.003	2	0.970	-179
800	0.965	178	0.45	17	0.003	14	0.968	-179
850	0.968	177	0.41	15	0.003	27	0.953	-179
900	0.969	176	0.37	13	0.003	36	0.949	180
950	0.970	176	0.34	11	0.003	45	0.943	179
1000	0.971	175	0.31	9	0.003	54	0.930	178



## 8 Package mechanical data

In order to meet environmental requirements, ST offers these devices in different grades of ECOPACK<sup>®</sup> packages, depending on their level of environmental compliance. ECOPACK<sup>®</sup> specifications, grade definitions and product status are available at: [www.st.com](http://www.st.com). ECOPACK<sup>®</sup> is an ST trademark.

**Table 14. PowerSO-10RF formed lead (Gull Wing) mechanical data**

Dim.	mm.			Inch		
	Min.	Typ.	Max.	Min.	Typ.	Max.
A1	0	0.05	0.1	0.	0.0019	0.0038
A2	3.4	3.5	3.6	0.134	0.137	0.142
A3	1.2	1.3	1.4	0.046	0.05	0.054
A4	0.15	0.2	0.25	0.005	0.007	0.009
a		0.2			0.007	
b	5.4	5.53	5.65	0.212	0.217	0.221
c	0.23	0.27	0.32	0.008	0.01	0.012
D	9.4	9.5	9.6	0.370	0.374	0.377
D1	7.4	7.5	7.6	0.290	0.295	0.298
E	13.85	14.1	14.35	0.544	0.555	0.565
E1	9.3	9.4	9.5	0.365	0.37	0.375
E2	7.3	7.4	7.5	0.286	0.292	0.294
E3	5.9	6.1	6.3	0.231	0.24	0.247
F		0.5			0.019	
G		1.2			0.047	
L	0.8	1	1.1	0.030	0.039	0.042
R1			0.25			0.01
R2		0.8			0.031	
T	2 deg	5 deg	8 deg	2 deg	5 deg	8 deg
T1		6 deg			6 deg	
T2		10 deg			10 deg	

*Note:* Resin protrusions not included (max value: 0.15 mm per side)

**Figure 24. Package dimensions PowerSO-10RF formed lead**



**Table 15. PowerSO-10RF straight lead mechanical data**

Dim.	mm.			Inch		
	Min.	Typ.	Max.	Min.	Typ.	Max.
A1	1.62	1.67	1.72	0.064	0.065	0.068
A2	3.4	3.5	3.6	0.134	0.137	0.142
A3	1.2	1.3	1.4	0.046	0.05	0.054
A4	0.15	0.2	0.25	0.005	0.007	0.009
a		0.2			0.007	
b	5.4	5.53	5.65	0.212	0.217	0.221
c	0.23	0.27	0.32	0.008	0.01	0.012
D	9.4	9.5	9.6	0.370	0.374	0.377
D1	7.4	7.5	7.6	0.290	0.295	0.298
E	15.15	15.4	15.65	0.595	0.606	0.615
E1	9.3	9.4	9.5	0.365	0.37	0.375
E2	7.3	7.4	7.5	0.286	0.292	0.294
E3	5.9	6.1	6.3	0.231	0.24	0.247
F		0.5			0.019	
G		1.2			0.047	
R1			0.25			0.01
R2		0.8			0.031	
T1		6 deg			6 deg	
T2		10 deg			10 deg	

Note: Resin protrusions not included (max value: 0.15 mm per side)

**Figure 25. Package dimensions PowerSO-10RF straight lead**

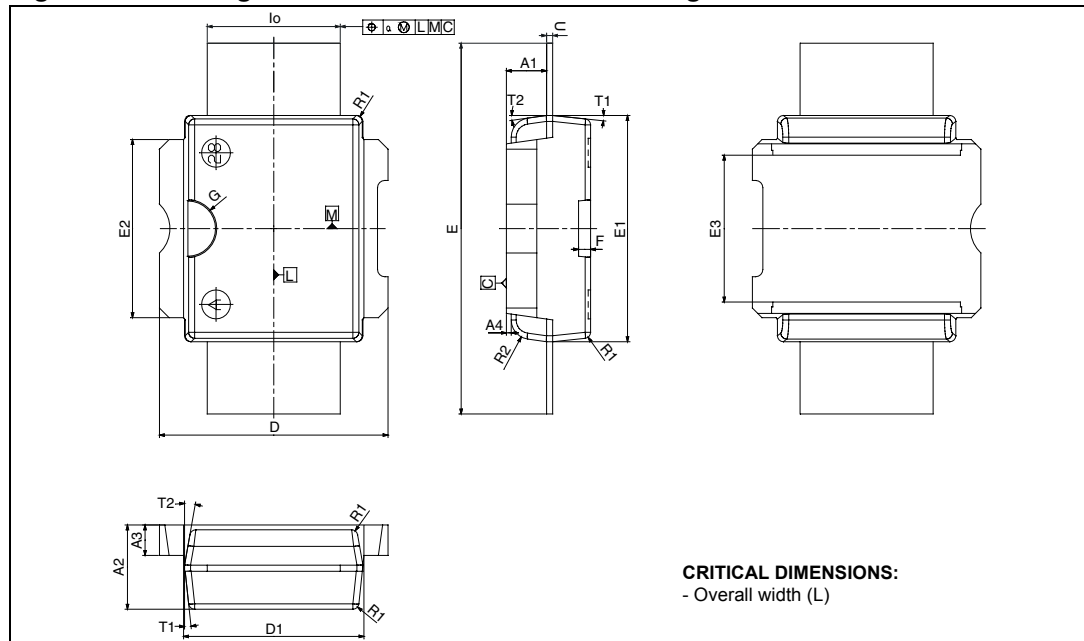
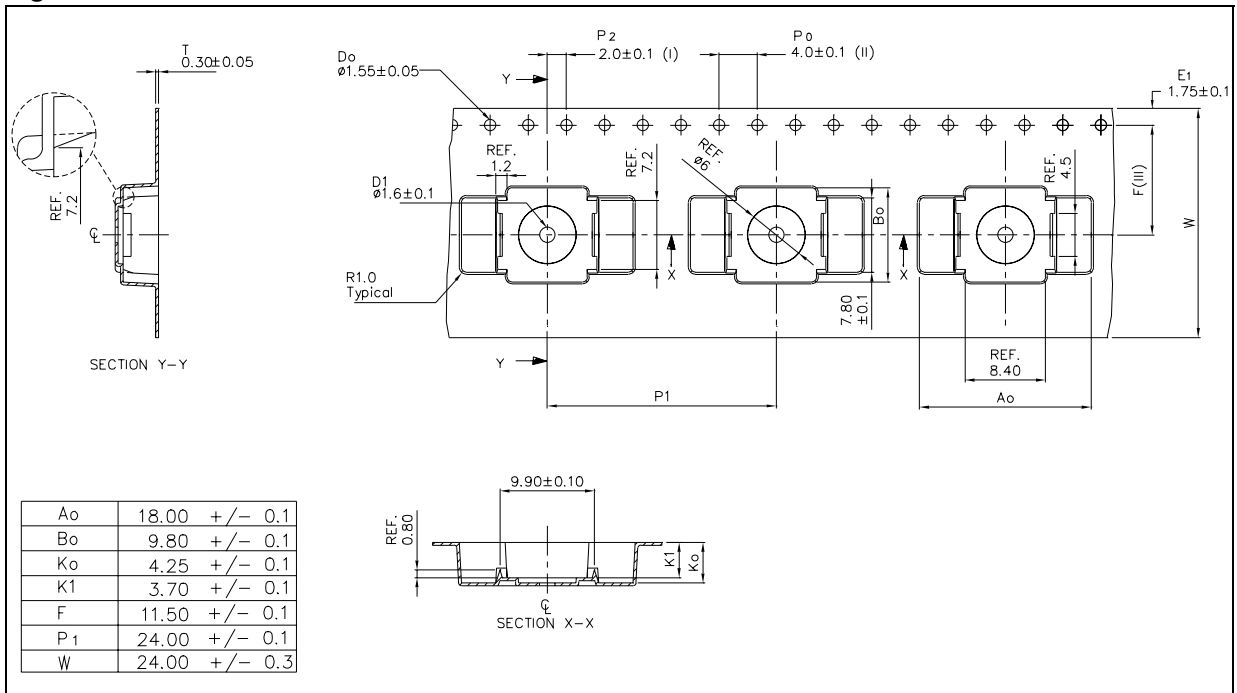



Figure 27. Reel information



## 9 Revision history

**Table 16. Document revision history**

Date	Revision	Changes
29-Apr-2006	1	Initial release.
03-Jun-2010	2	Added: <a href="#">Table 6: Moisture sensitivity level</a> .

**Please Read Carefully:**

Information in this document is provided solely in connection with ST products. STMicroelectronics NV and its subsidiaries ("ST") reserve the right to make changes, corrections, modifications or improvements, to this document, and the products and services described herein at any time, without notice.

All ST products are sold pursuant to ST's terms and conditions of sale.

Purchasers are solely responsible for the choice, selection and use of the ST products and services described herein, and ST assumes no liability whatsoever relating to the choice, selection or use of the ST products and services described herein.

No license, express or implied, by estoppel or otherwise, to any intellectual property rights is granted under this document. If any part of this document refers to any third party products or services it shall not be deemed a license grant by ST for the use of such third party products or services, or any intellectual property contained therein or considered as a warranty covering the use in any manner whatsoever of such third party products or services or any intellectual property contained therein.

**UNLESS OTHERWISE SET FORTH IN ST'S TERMS AND CONDITIONS OF SALE ST DISCLAIMS ANY EXPRESS OR IMPLIED WARRANTY WITH RESPECT TO THE USE AND/OR SALE OF ST PRODUCTS INCLUDING WITHOUT LIMITATION IMPLIED WARRANTIES OF MERCHANTABILITY, FITNESS FOR A PARTICULAR PURPOSE (AND THEIR EQUIVALENTS UNDER THE LAWS OF ANY JURISDICTION), OR INFRINGEMENT OF ANY PATENT, COPYRIGHT OR OTHER INTELLECTUAL PROPERTY RIGHT.**

**UNLESS EXPRESSLY APPROVED IN WRITING BY AN AUTHORIZED ST REPRESENTATIVE, ST PRODUCTS ARE NOT RECOMMENDED, AUTHORIZED OR WARRANTED FOR USE IN MILITARY, AIR CRAFT, SPACE, LIFE SAVING, OR LIFE SUSTAINING APPLICATIONS, NOR IN PRODUCTS OR SYSTEMS WHERE FAILURE OR MALFUNCTION MAY RESULT IN PERSONAL INJURY, DEATH, OR SEVERE PROPERTY OR ENVIRONMENTAL DAMAGE. ST PRODUCTS WHICH ARE NOT SPECIFIED AS "AUTOMOTIVE GRADE" MAY ONLY BE USED IN AUTOMOTIVE APPLICATIONS AT USER'S OWN RISK.**

Resale of ST products with provisions different from the statements and/or technical features set forth in this document shall immediately void any warranty granted by ST for the ST product or service described herein and shall not create or extend in any manner whatsoever, any liability of ST.

ST and the ST logo are trademarks or registered trademarks of ST in various countries.

Information in this document supersedes and replaces all information previously supplied.

The ST logo is a registered trademark of STMicroelectronics. All other names are the property of their respective owners.

© 2010 STMicroelectronics - All rights reserved

STMicroelectronics group of companies

Australia - Belgium - Brazil - Canada - China - Czech Republic - Finland - France - Germany - Hong Kong - India - Israel - Italy - Japan - Malaysia - Malta - Morocco - Philippines - Singapore - Spain - Sweden - Switzerland - United Kingdom - United States of America

[www.st.com](http://www.st.com)

