

NPN Silicon Digital Transistor

- Switching circuit, inverter, interface circuit driver circuit
- Built in bias resistor ($R_1=10\text{ k}\Omega$, $R_2=47\text{ k}\Omega$)
- BCR135S: Two internally isolated transistors with good matching in one multichip package
- BCR135S: For orientation in reel see package information below
- Pb-free (RoHS compliant) package ¹⁾
- Qualified according AEC Q101

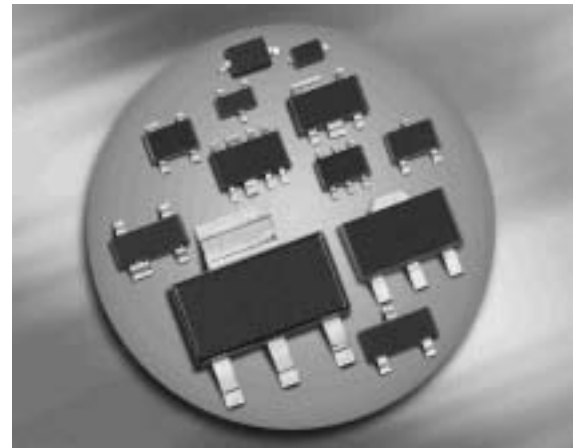

BCR135/F
BCR135W

BCR135S

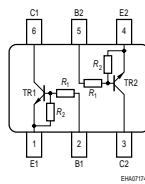
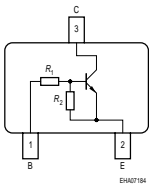

Type	Marking	Pin Configuration						Package
		1=B	2=E	3=C	-	-	-	
BCR135	WJs	1=B	2=E	3=C	-	-	-	SOT23
BCR135F	WJs	1=B	2=E	3=C	-	-	-	TSFP-3
BCR135S	WJs	1=E1	2=B1	3=C2	4=E2	5=B2	6=C1	SOT363
BCR135W	WJs	1=B	2=E	3=C	-	-	-	SOT323

¹Pb-containing package may be available upon special request

Maximum Ratings

Parameter	Symbol	Value	Unit	
Collector-emitter voltage	V_{CEO}	50	V	
Collector-base voltage	V_{CBO}	50		
Input forward voltage	$V_{i(fwd)}$	40		
Input reverse voltage	$V_{i(rev)}$	6		
Collector current	I_C	100	mA	
Total power dissipation	P_{tot}		mW	
BCR135, $T_S \leq 102^\circ\text{C}$				200
BCR135F, $T_S \leq 128^\circ\text{C}$				250
BCR135S, $T_S \leq 115^\circ\text{C}$				250
BCR135W, $T_S \leq 124^\circ\text{C}$				250
Junction temperature	T_j	150	°C	
Storage temperature	T_{stg}	-65 ... 150		

Thermal Resistance

Parameter	Symbol	Value	Unit	
Junction - soldering point ¹⁾	R_{thJS}		K/W	
BCR135				≤ 240
BCR135F				≤ 90
BCR135S				≤ 140
BCR135W				≤ 105

¹⁾For calculation of R_{thJA} please refer to Application Note Thermal Resistance

Electrical Characteristics at $T_A = 25^\circ\text{C}$, unless otherwise specified

Parameter	Symbol	Values			Unit
		min.	typ.	max.	
DC Characteristics					
Collector-emitter breakdown voltage $I_C = 100 \mu\text{A}, I_B = 0$	$V_{(BR)CEO}$	50	-	-	V
Collector-base breakdown voltage $I_C = 10 \mu\text{A}, I_E = 0$	$V_{(BR)CBO}$	50	-	-	
Collector-base cutoff current $V_{CB} = 40 \text{ V}, I_E = 0$	I_{CBO}	-	-	100	nA
Emitter-base cutoff current $V_{EB} = 6 \text{ V}, I_C = 0$	I_{EBO}	-	-	167	μA
DC current gain ¹⁾ $I_C = 5 \text{ mA}, V_{CE} = 5 \text{ V}$	h_{FE}	70	-	-	-
Collector-emitter saturation voltage ¹⁾ $I_C = 10 \text{ mA}, I_B = 0.5 \text{ mA}$	V_{CEsat}	-	-	0.3	V
Input off voltage $I_C = 100 \mu\text{A}, V_{CE} = 5 \text{ V}$	$V_{i(off)}$	0.5	-	1	
Input on voltage $I_C = 2 \text{ mA}, V_{CE} = 0.3 \text{ V}$	$V_{i(on)}$	0.5	-	1.4	
Input resistor	R_1	7	10	13	$\text{k}\Omega$
Resistor ratio	R_1/R_2	0.19	0.21	0.24	-
AC Characteristics					
Transition frequency $I_C = 10 \text{ mA}, V_{CE} = 5 \text{ V}, f = 100 \text{ MHz}$	f_T	-	150	-	MHz
Collector-base capacitance $V_{CB} = 10 \text{ V}, f = 1 \text{ MHz}$	C_{cb}	-	3	-	pF

¹Pulse test: $t < 300 \mu\text{s}; D < 2\%$

DC current gain $h_{FE} = f(I_C)$

$V_{CE} = 5V$ (common emitter configuration)

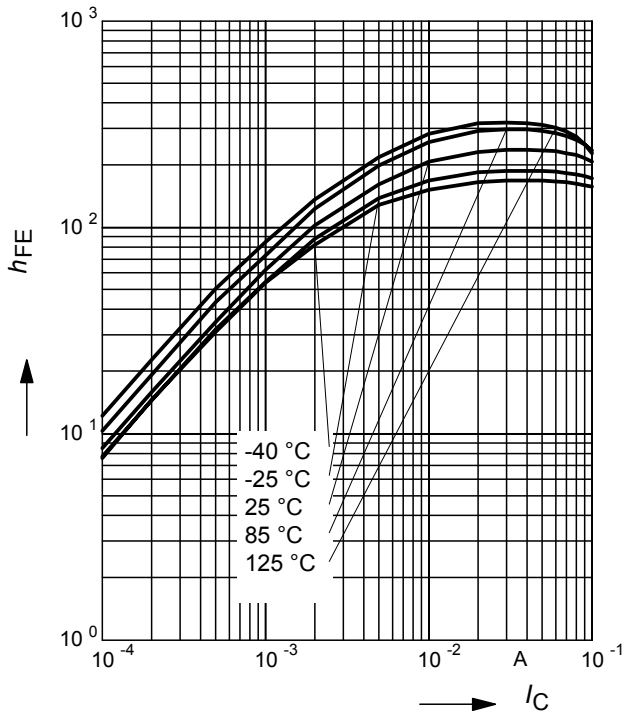

Collector-emitter saturation voltage

$V_{CEsat} = f(I_C), I_C/I_B = 20$

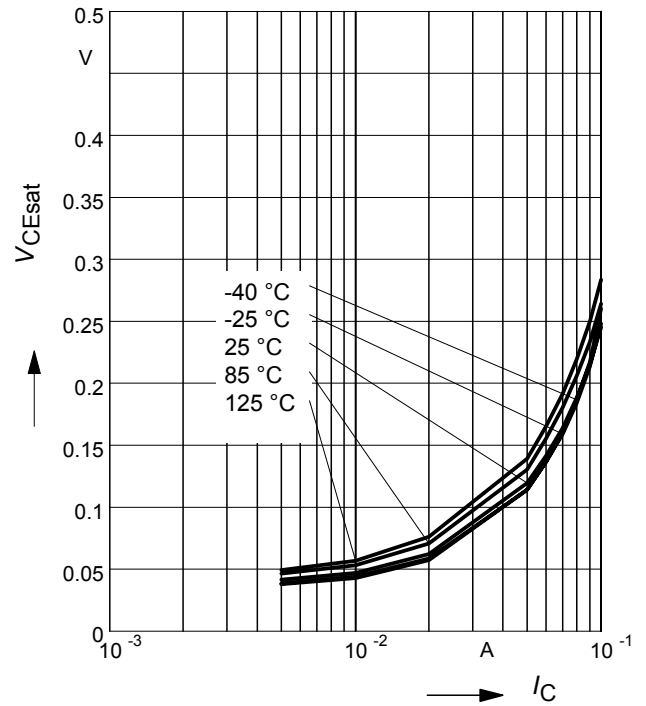

Input on Voltage $V_{i(on)} = f(I_C)$

$V_{CE} = 0.3V$ (common emitter configuration)

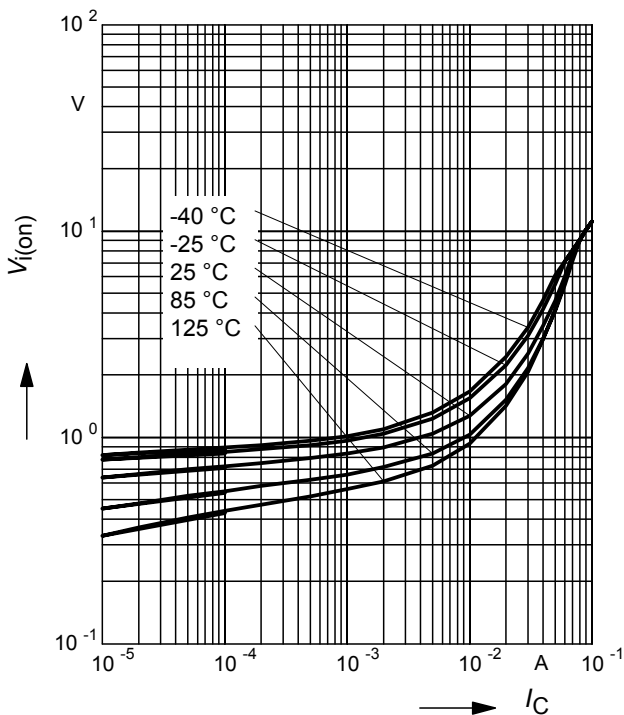

Input off voltage $V_{i(off)} = f(I_C)$

$V_{CE} = 5V$ (common emitter configuration)

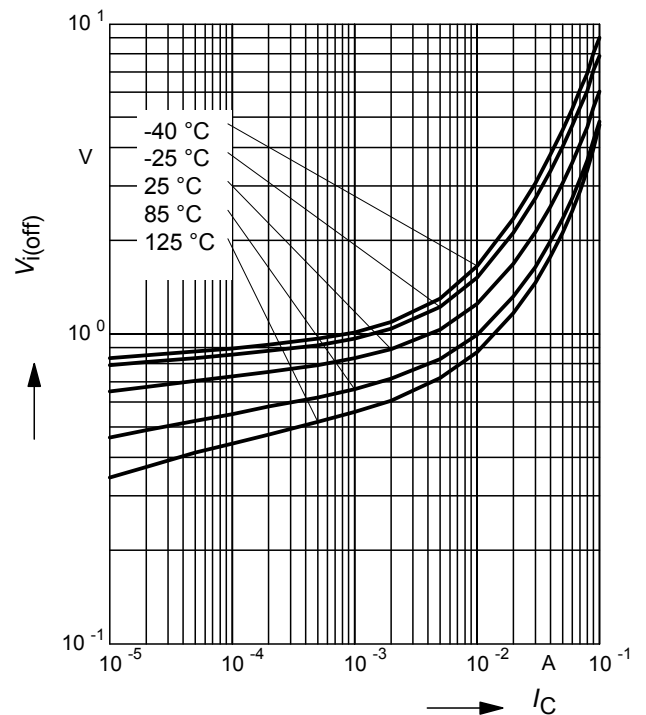

Total power dissipation $P_{tot} = f(T_S)$

BCR135



Total power dissipation $P_{tot} = f(T_S)$

BCR135F



Total power dissipation $P_{tot} = f(T_S)$

BCR135S



Total power dissipation $P_{tot} = f(T_S)$

BCR135W



Permissible Pulse Load $R_{thJS} = f(t_p)$

BCR135



Permissible Pulse Load

$P_{totmax}/P_{totDC} = f(t_p)$

BCR135



Permissible Puls Load $R_{thJS} = f(t_p)$

BCR135F



Permissible Pulse Load

$P_{totmax}/P_{totDC} = f(t_p)$

BCR135F



Permissible Puls Load $R_{thJS} = f(t_p)$

BCR135S



Permissible Pulse Load

$P_{totmax}/P_{totDC} = f(t_p)$

BCR135S



Permissible Puls Load $R_{thJS} = f(t_p)$

BCR135W

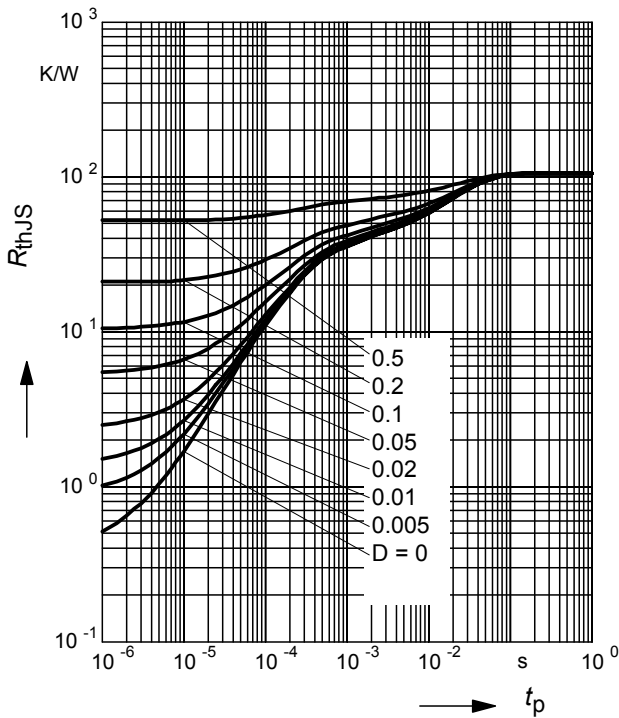

Permissible Pulse Load

$P_{totmax}/P_{totDC} = f(t_p)$

BCR135W



Package Outline



1) Lead width can be 0.6 max. in dambar area

Foot Print

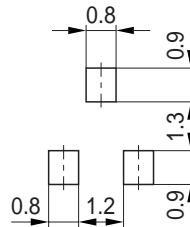

Marking Layout (Example)

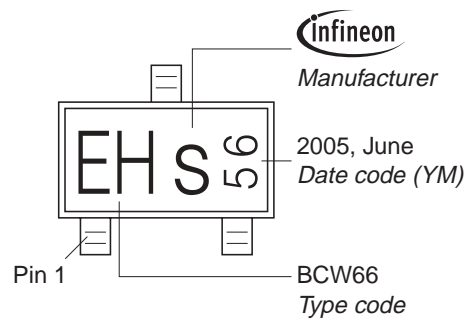

Standard Packing

Reel \varnothing 180 mm = 3.000 Pieces/Reel
 Reel \varnothing 330 mm = 10.000 Pieces/Reel

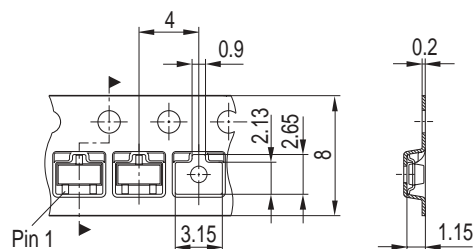

Package Outline

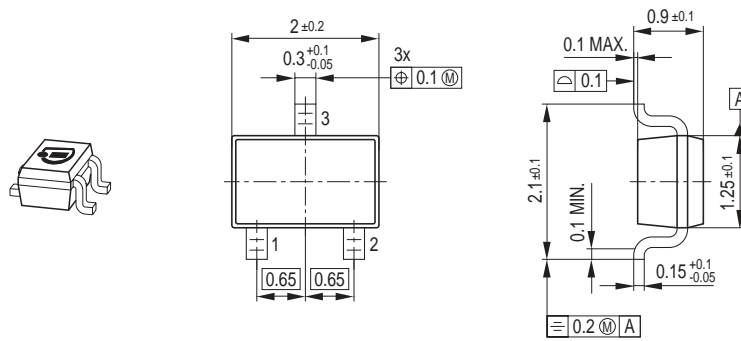

Foot Print

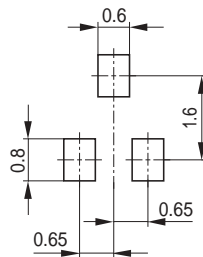

Marking Layout (Example)

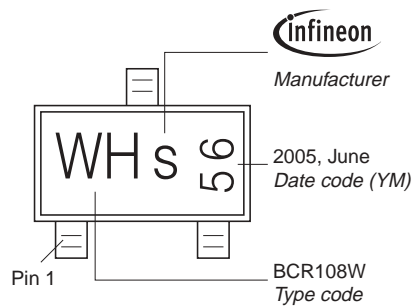

Standard Packing

Reel $\varnothing 180$ mm = 3.000 Pieces/Reel
 Reel $\varnothing 330$ mm = 10.000 Pieces/Reel

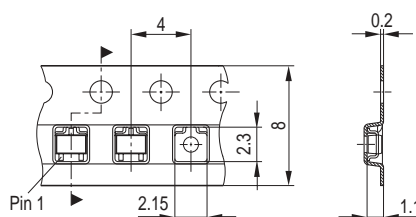

Package Outline

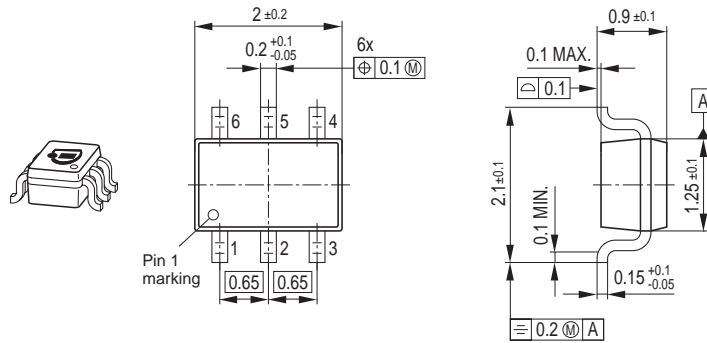

Foot Print

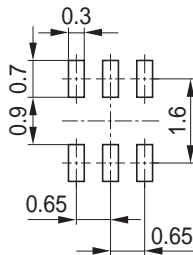

Marking Layout (Example)

Small variations in positioning of Date code, Type code and Manufacture are possible.

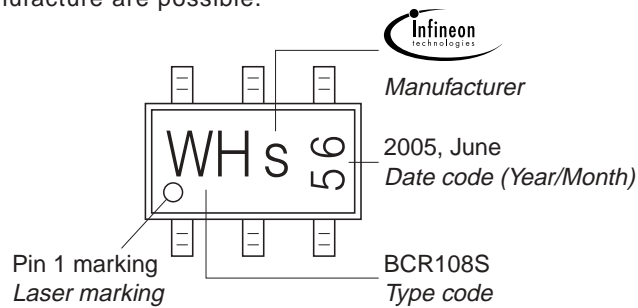

Standard Packing

Reel \varnothing 180 mm = 3.000 Pieces/Reel
 Reel \varnothing 330 mm = 10.000 Pieces/Reel

For symmetric types no defined Pin 1 orientation in reel.

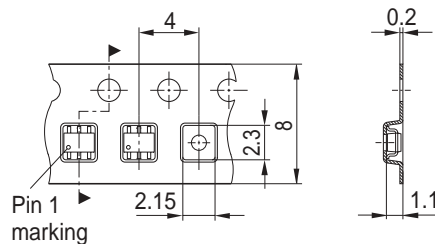

Package Outline

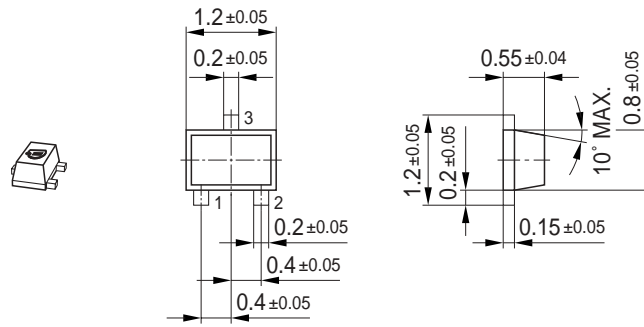

Foot Print

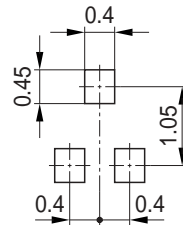

Marking Layout (Example)

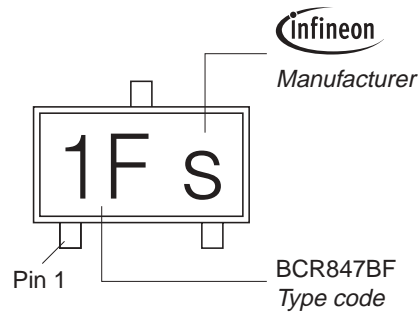

Standard Packing

Reel ø180 mm = 3.000 Pieces/Reel
 Reel ø330 mm = 10.000 Pieces/Reel

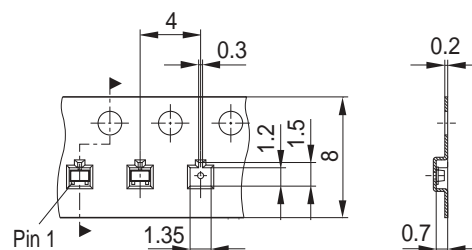

Edition 2006-02-01
Published by
Infineon Technologies AG
81726 München, Germany
© Infineon Technologies AG 2007.
All Rights Reserved.

Attention please!

The information given in this dokument shall in no event be regarded as a guarantee of conditions or characteristics ("Beschaffenheitsgarantie"). With respect to any examples or hints given herein, any typical values stated herein and/or any information regarding the application of the device, Infineon Technologies hereby disclaims any and all warranties and liabilities of any kind, including without limitation warranties of non-infringement of intellectual property rights of any third party.

Information

For further information on technology, delivery terms and conditions and prices please contact your nearest Infineon Technologies Office (www.infineon.com).

Warnings

Due to technical requirements components may contain dangerous substances. For information on the types in question please contact your nearest Infineon Technologies Office.

Infineon Technologies Components may only be used in life-support devices or systems with the express written approval of Infineon Technologies, if a failure of such components can reasonably be expected to cause the failure of that life-support device or system, or to affect the safety or effectiveness of that device or system.

Life support devices or systems are intended to be implanted in the human body, or to support and/or maintain and sustain and/or protect human life. If they fail, it is reasonable to assume that the health of the user or other persons may be endangered.