

BLF6G27-45; BLF6G27S-45

WiMAX power LDMOS transistor

Rev. 03 — 15 December 2008

Product data sheet

1. Product profile

1.1 General description

45 W LDMOS power transistor for base station applications at frequencies from 2500 MHz to 2700 MHz.

Table 1. Typical performance

RF performance at $T_{case} = 25\text{ }^{\circ}\text{C}$ in a class-AB production test circuit.

Mode of operation	f (MHz)	V _{DS} (V)	P _{L(AV)} (W)	G _p (dB)	η_D (%)	ACPR _{885k} (dBc)	ACPR _{1980k} (dBc)
1-carrier N-CDMA ^[1]	2500 to 2700	28	7	18	24	-49 ^[2]	-64 ^[2]

[1] Single carrier N-CDMA with pilot, paging sync and 6 traffic channels (Walsh codes 8 - 13). PAR = 9.7 dB at 0.01 % probability on CCDF. Channel bandwidth is 1.23 MHz.

[2] Measured within 30 kHz bandwidth.

CAUTION



This device is sensitive to ElectroStatic Discharge (ESD). Therefore care should be taken during transport and handling.

1.2 Features

- Typical 1-carrier N-CDMA performance (single carrier N-CDMA with pilot, paging, sync and 6 traffic channels [Walsh codes 8 - 13]. PAR = 9.7 dB at 0.01 % probability on CCDF. Channel bandwidth is 1.23 MHz), a supply voltage of 28 V and an I_{Dq} of 350 mA:
- Qualified up to a maximum V_{DS} operation of 32 V
- Integrated ESD protection
- Excellent ruggedness
- High efficiency
- Excellent thermal stability
- Designed for broadband operation
- Internally matched for ease of use
- Low gold plating thickness on leads
- Compliant to Directive 2002/95/EC, regarding Restriction of Hazardous Substances (RoHS)

1.3 Applications

- RF power amplifiers for base stations and multi carrier applications in the 2500 MHz to 2700 MHz frequency range

2. Pinning information

Table 2. Pinning

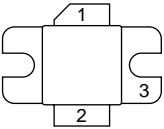
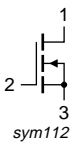
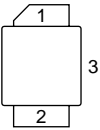
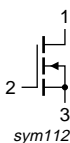
Pin	Description	Simplified outline	Graphic symbol
BLF6G27-45 (SOT608A)			
1	drain		 sym112
2	gate		
3	source		
BLF6G27S-45 (SOT608B)			
1	drain		 sym112
2	gate		
3	source		

[1] Connected to flange.

3. Ordering information

Table 3. Ordering information

Type number	Package		
	Name	Description	Version
BLF6G27-45	-	flanged ceramic package; 2 mounting holes; 2 leads	SOT608A
BLF6G27S-45	-	ceramic earless flanged package; 2 leads	SOT608B

4. Limiting values

Table 4. Limiting values

In accordance with the Absolute Maximum Rating System (IEC 60134).

Symbol	Parameter	Conditions	Min	Max	Unit
V_{DS}	drain-source voltage		-	65	V
V_{GS}	gate-source voltage		-0.5	+13	V
I_D	drain current		-	20	A
T_{stg}	storage temperature		-65	+150	°C
T_j	junction temperature		-	200	°C

5. Thermal characteristics

Table 5. Thermal characteristics

Symbol	Parameter	Conditions	Type	Typ	Unit
$R_{th(j-case)}$	thermal resistance from junction to case	$T_{case} = 80\text{ °C};$	BLF6G27-45	1.7	K/W
		$P_L = 34\text{ W (CW)}$	BLF6G27S-45	1.7	K/W

6. Characteristics

Table 6. Characteristics

$T_j = 25\text{ °C}$ per section; unless otherwise specified.

Symbol	Parameter	Conditions	Min	Typ	Max	Unit
$V_{(BR)DSS}$	drain-source breakdown voltage	$V_{GS} = 0\text{ V}; I_D = 0.5\text{ mA}$	65	-	-	V
$V_{GS(th)}$	gate-source threshold voltage	$V_{DS} = 10\text{ V}; I_D = 60\text{ mA}$	1.4	1.9	2.4	V
I_{DSS}	drain leakage current	$V_{GS} = 0\text{ V}; V_{DS} = 28\text{ V}$	-	-	1.4	μA
I_{DSX}	drain cut-off current	$V_{GS} = V_{GS(th)} + 3.75\text{ V};$ $V_{DS} = 10\text{ V}$	8.8	10.4	-	A
I_{GSS}	gate leakage current	$V_{GS} = 11\text{ V}; V_{DS} = 0\text{ V}$	-	-	140	nA
g_{fs}	forward transconductance	$V_{DS} = 10\text{ V}; I_D = 2.5\text{ A}$	-	4.3	-	S
$R_{DS(on)}$	drain-source on-state resistance	$V_{GS} = V_{GS(th)} + 3.75\text{ V};$ $I_D = 2.1\text{ A}$	-	0.24	0.385	Ω
C_{rs}	feedback capacitance	$V_{GS} = 0\text{ V}; V_{DS} = 28\text{ V};$ $f = 1\text{ MHz}$	-	1.1	-	pF

7. Application information

Table 7. Application information

Mode of operation: Single carrier N-CDMA with pilot, paging, sync and 6 traffic channels (Walsh codes 8 - 13). PAR 9.7 dB at 0.01 % probability on CCDF; channel bandwidth = 1.23 MHz; $f = 2700\text{ MHz}$; RF performance at $V_{DS} = 28\text{ V}; I_{Dq} = 350\text{ mA}; T_{case} = 25\text{ °C}$; unless otherwise specified; in a class-AB production circuit.

Symbol	Parameter	Conditions	Min	Typ	Max	Unit
$P_{L(AV)}$	average output power		-	7	-	W
G_p	power gain	$P_{L(AV)} = 7\text{ W}$	16.5	18	-	dB
RL_{in}	input return loss	$P_{L(AV)} = 7\text{ W}$	-	-10	-5	dB
η_D	drain efficiency	$P_{L(AV)} = 7\text{ W}$	22	24	-	%
$ACPR_{885k}$	adjacent channel power ratio (885 kHz)	$P_{L(AV)} = 7\text{ W}$ [1]	-	-49	-46	dBc
$ACPR_{1980k}$	adjacent channel power ratio (1980 kHz)	$P_{L(AV)} = 7\text{ W}$ [1]	-	-64	-61	dBc

[1] Measured within 30 kHz bandwidth.

7.1 Ruggedness in class-AB operation

The BLF6G27-45 and BLF6G27S-45 are capable of withstanding a load mismatch corresponding to $VSWR = 10 : 1$ through all phases under the following conditions: $V_{DS} = 28\text{ V}; I_{Dq} = 350\text{ mA}; P_L = 45\text{ W (CW)}; f = 2600\text{ MHz}$.

7.2 Single carrier N-CDMA performance

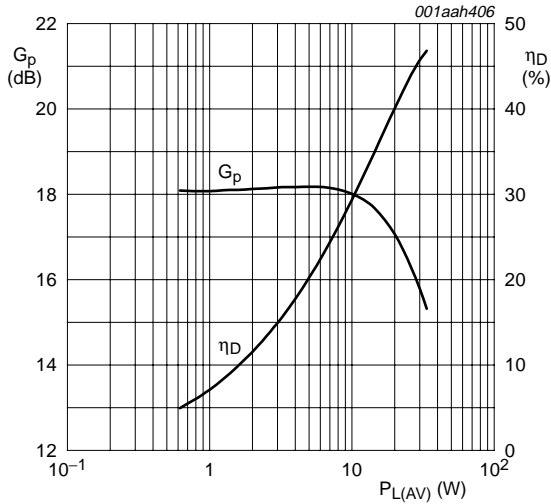

$V_{DS} = 28$ V; $I_{DQ} = 350$ mA; $f = 2600$ MHz; single carrier N-CDMA; PAR = 9.7 dB at 0.01 % probability; channel bandwidth = 1.23 MHz; instantaneous bandwidth = 30 kHz.

Fig 1. Power gain and drain efficiency as functions of average load power; typical values

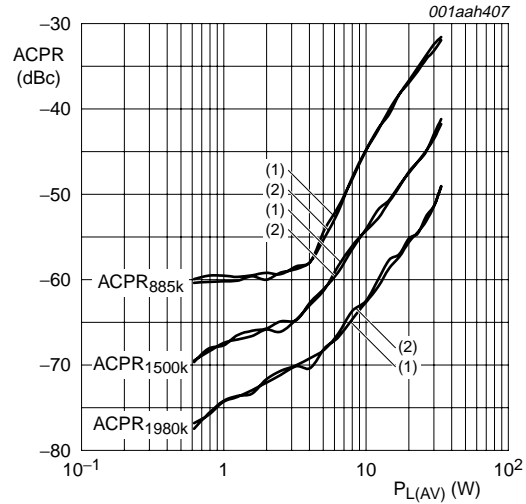

$V_{DS} = 28$ V; $I_{DQ} = 350$ mA; $f = 2600$ MHz; single carrier N-CDMA; PAR = 9.7 dB at 0.01 % probability; channel bandwidth = 1.23 MHz; instantaneous bandwidth = 30 kHz.

- (1) Low frequency component
- (2) High frequency component

Fig 2. Adjacent channel power ratio as function of average load power; typical values

7.3 Two-tone

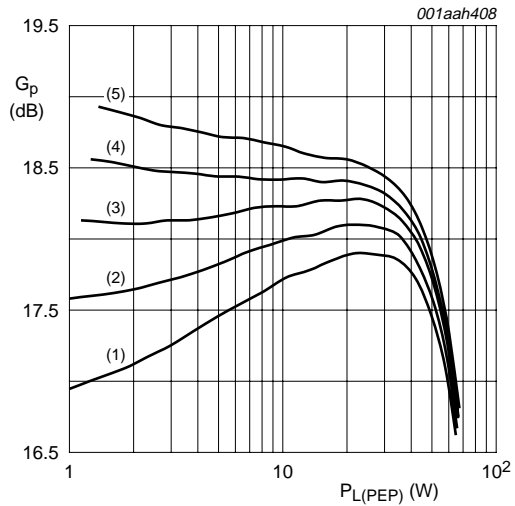

$V_{DS} = 28\text{ V}$; $f_1 = 2598.75\text{ MHz}$; $f_2 = 2601.25\text{ MHz}$;
2.5 MHz tone spacing.

- (1) $I_{Dq} = 250\text{ mA}$
- (2) $I_{Dq} = 300\text{ mA}$
- (3) $I_{Dq} = 350\text{ mA}$
- (4) $I_{Dq} = 400\text{ mA}$
- (5) $I_{Dq} = 500\text{ mA}$

Fig 3. Power gain as function of peak envelope load power; typical values

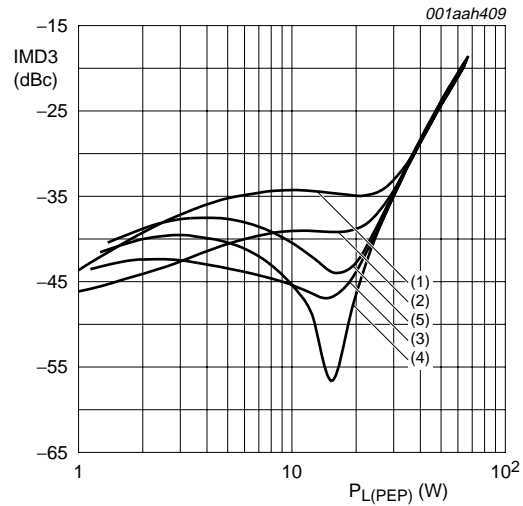

$V_{DS} = 28\text{ V}$; $f_1 = 2598.75\text{ MHz}$; $f_2 = 2601.25\text{ MHz}$;
2.5 MHz tone spacing.

- (1) $I_{Dq} = 250\text{ mA}$
- (2) $I_{Dq} = 300\text{ mA}$
- (3) $I_{Dq} = 350\text{ mA}$
- (4) $I_{Dq} = 400\text{ mA}$
- (5) $I_{Dq} = 500\text{ mA}$

Fig 4. Third order intermodulation distortion as function of peak envelope load power; typical values

7.4 Continuous wave

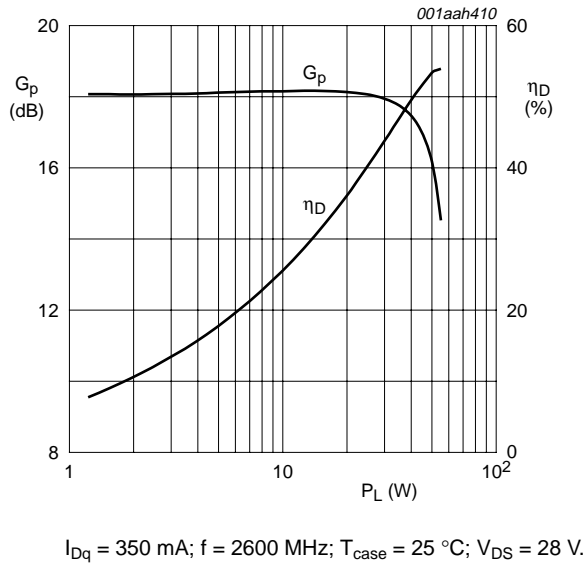

Fig 5. Power gain and drain efficiency as functions of CW load power; typical values

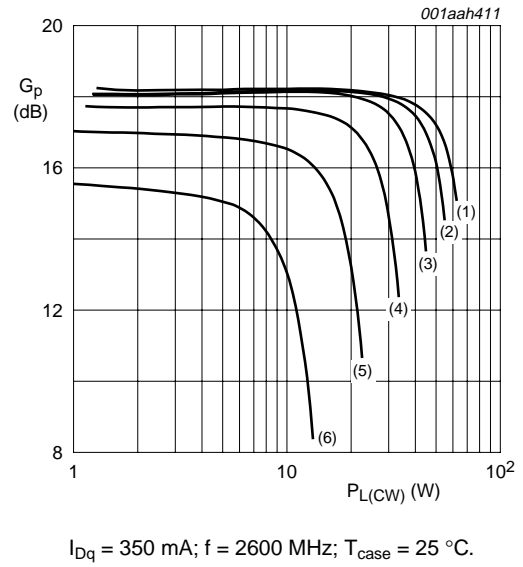
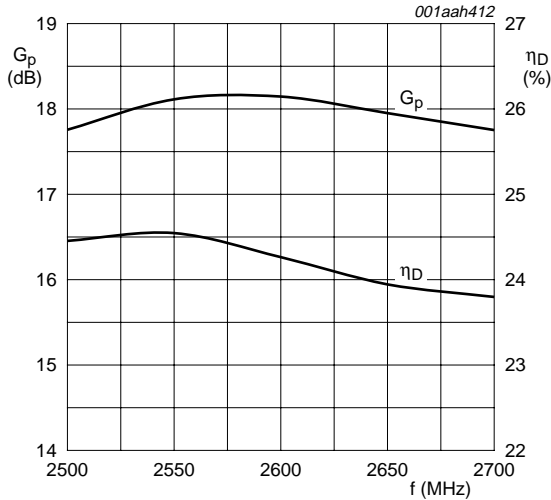

Fig 6. Power gain as function of CW load power; typical values

- (1) $V_{DS} = 32 \text{ V}$
- (2) $V_{DS} = 28 \text{ V}$
- (3) $V_{DS} = 24 \text{ V}$
- (4) $V_{DS} = 20 \text{ V}$
- (5) $V_{DS} = 16 \text{ V}$
- (6) $V_{DS} = 12 \text{ V}$

7.5 Single carrier N-CDMA broadband performance at 7 W average



$V_{DS} = 28$ V; $I_{Dq} = 350$ mA; single carrier N-CDMA;
 PAR = 9.7 dB at 0.01 % probability;
 instantaneous bandwidth = 30 kHz.

Fig 7. Power gain and drain efficiency as functions of frequency; typical values

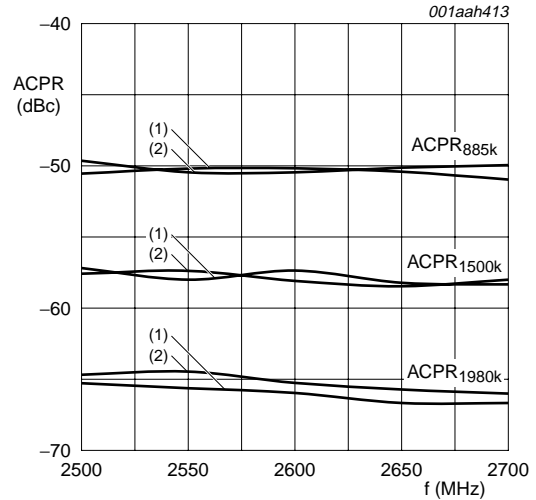

$V_{DS} = 28$ V; $I_{Dq} = 350$ mA; single carrier N-CDMA;
 PAR = 9.7 dB at 0.01 % probability;
 instantaneous bandwidth = 30 kHz.

- (1) Low frequency component
- (2) High frequency component

Fig 8. Adjacent channel power ratio as function of frequency; typical values

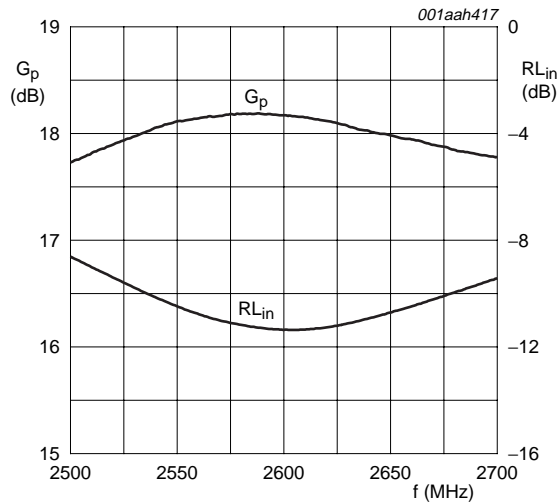

$V_{DS} = 28$ V; $I_{Dq} = 350$ mA; single carrier N-CDMA; PAR = 9.7 dB at 0.01 % probability; instantaneous bandwidth = 30 kHz.

Fig 9. Power gain and input return loss as functions of frequency

7.6 Single carrier N-CDMA broadband performance at 20 W average

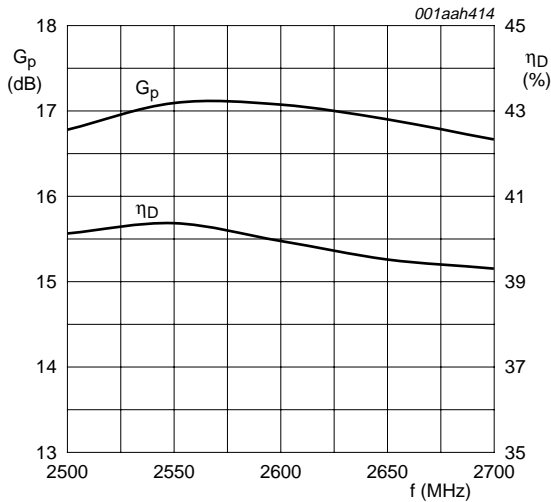

$V_{DS} = 28\text{ V}$; $I_{Dq} = 350\text{ mA}$; single carrier N-CDMA;
 PAR = 9.7 dB at 0.01 % probability;
 instantaneous bandwidth = 30 kHz.

Fig 10. Power gain and drain efficiency as functions of frequency; typical values

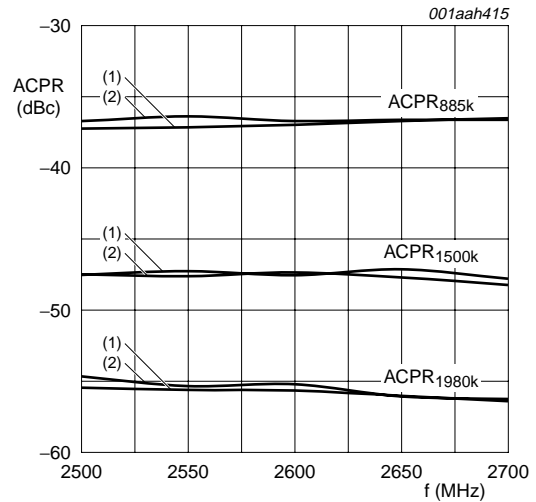

$V_{DS} = 28\text{ V}$; $I_{Dq} = 350\text{ mA}$; single carrier N-CDMA;
 PAR = 9.7 dB at 0.01 % probability;
 instantaneous bandwidth = 30 kHz.

- (1) Low frequency component
- (2) High frequency component

Fig 11. Adjacent channel power ratio as function of frequency; typical values

8. Test information

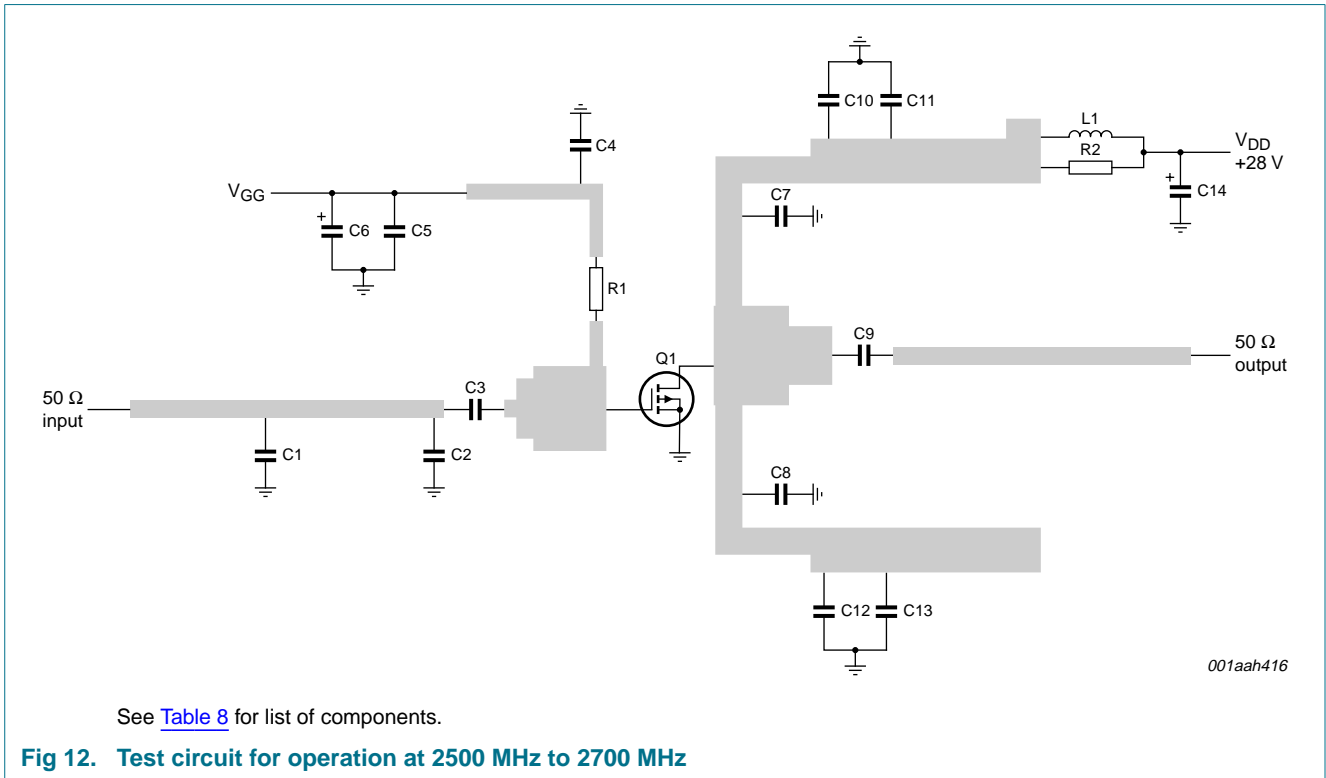

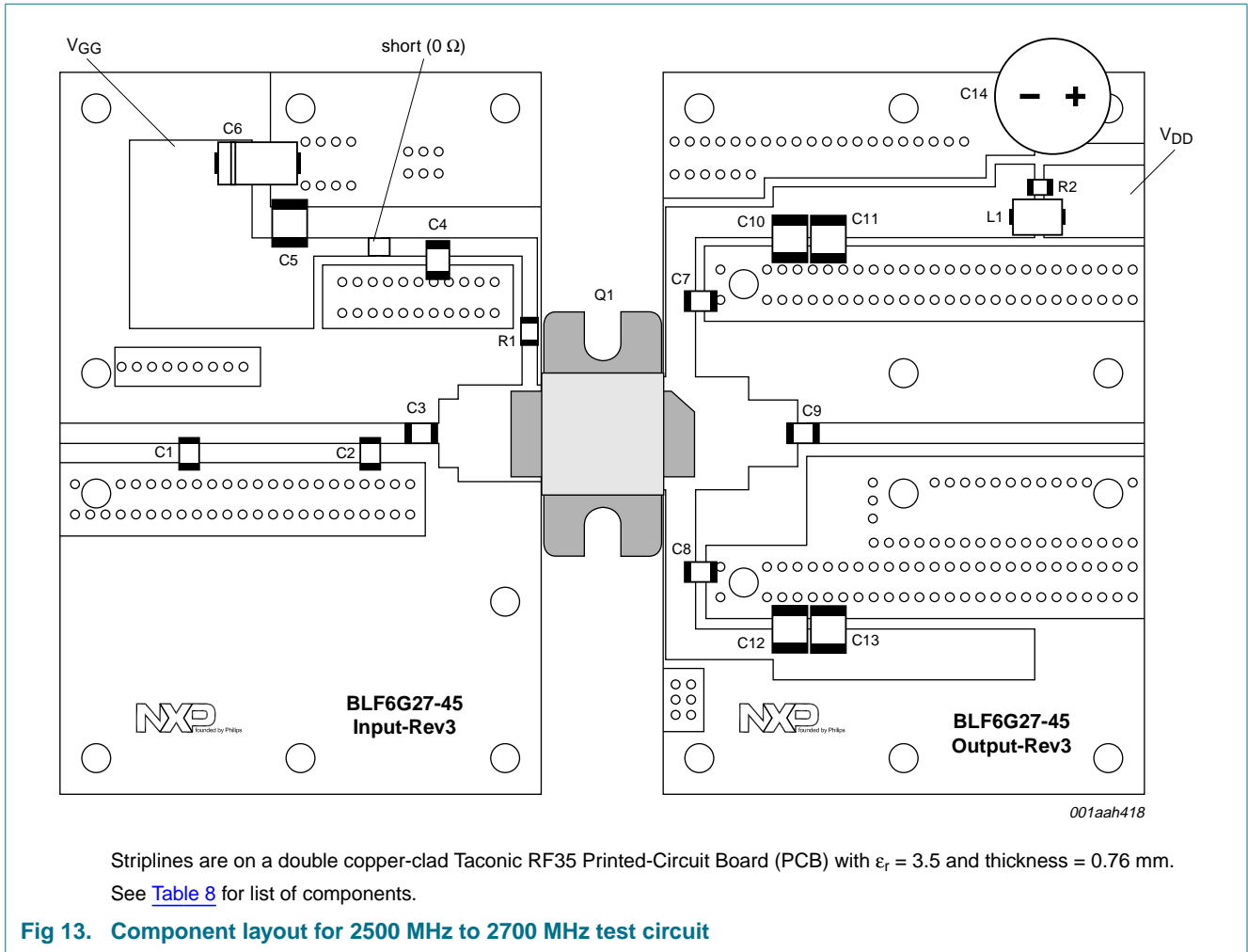

Table 8. List of components

For test circuit, see [Figure 12](#) and [Figure 13](#).

Component	Description	Value	Remarks
C1	multilayer ceramic chip capacitor	0.3 pF	[1]
C2	multilayer ceramic chip capacitor	0.5 pF	[1]
C3, C4, C7, C8	multilayer ceramic chip capacitor	11 pF	[1]
C5, C10, C11, C12, C13	multilayer ceramic chip capacitor	4.7 μ F	C4532X7R1H475M
C6	tantalum capacitor	10 μ F; 35 V	Kemet (Farnell)
C9	multilayer ceramic chip capacitor	8.2 pF	
C14	electrolytic capacitor	470 μ F; 63 V	
L1	ferrite SMD bead	-	Ferroxcube BDS 3/3/4.6-4S2 or equivalent
R1	resistor	22 Ω	package 0603
R2	resistor	12 Ω	package 1206
Q1	BLF6G27-45 or BLF6G27S-45	-	

[1] American Technical Ceramics type 100B or capacitor of same quality.

Table 9. Measured test circuit impedances

f (GHz)	Z _i (Ω)	Z _o (Ω)
2.50	11.1 – j11.0	18.4 – j9.1
2.55	10.6 – j10.8	16.9 – j9.2
2.60	10.1 – j10.5	15.6 – j9.2
2.65	9.6 – j10.2	14.4 – j9.1
2.70	9.1 – j9.8	13.3 – j8.9

9. Package outline

Flanged ceramic package; 2 mounting holes; 2 leads

SOT608A

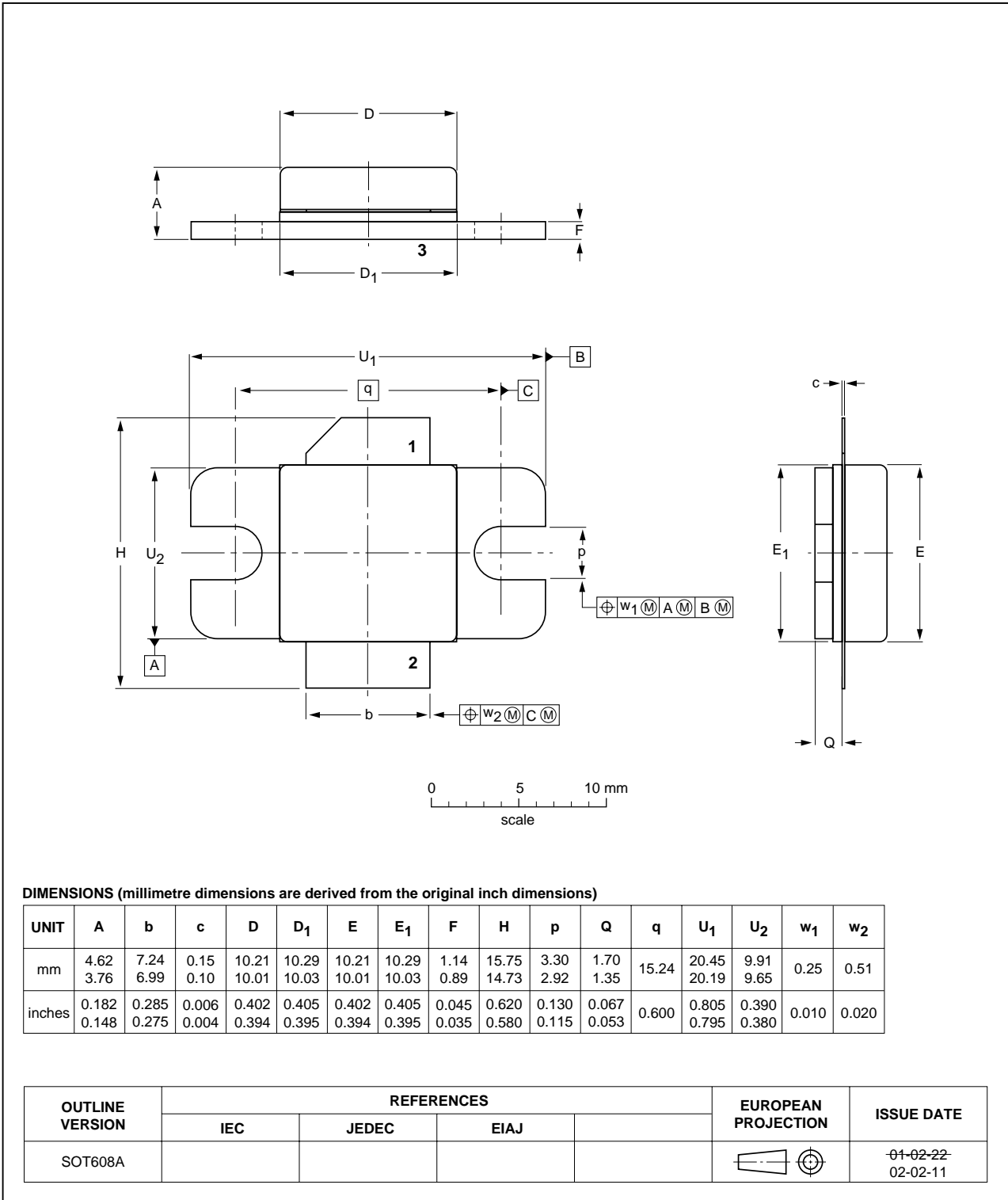

Fig 14. Package outline SOT608A

Ceramic earless flanged package; 2 leads

SOT608B

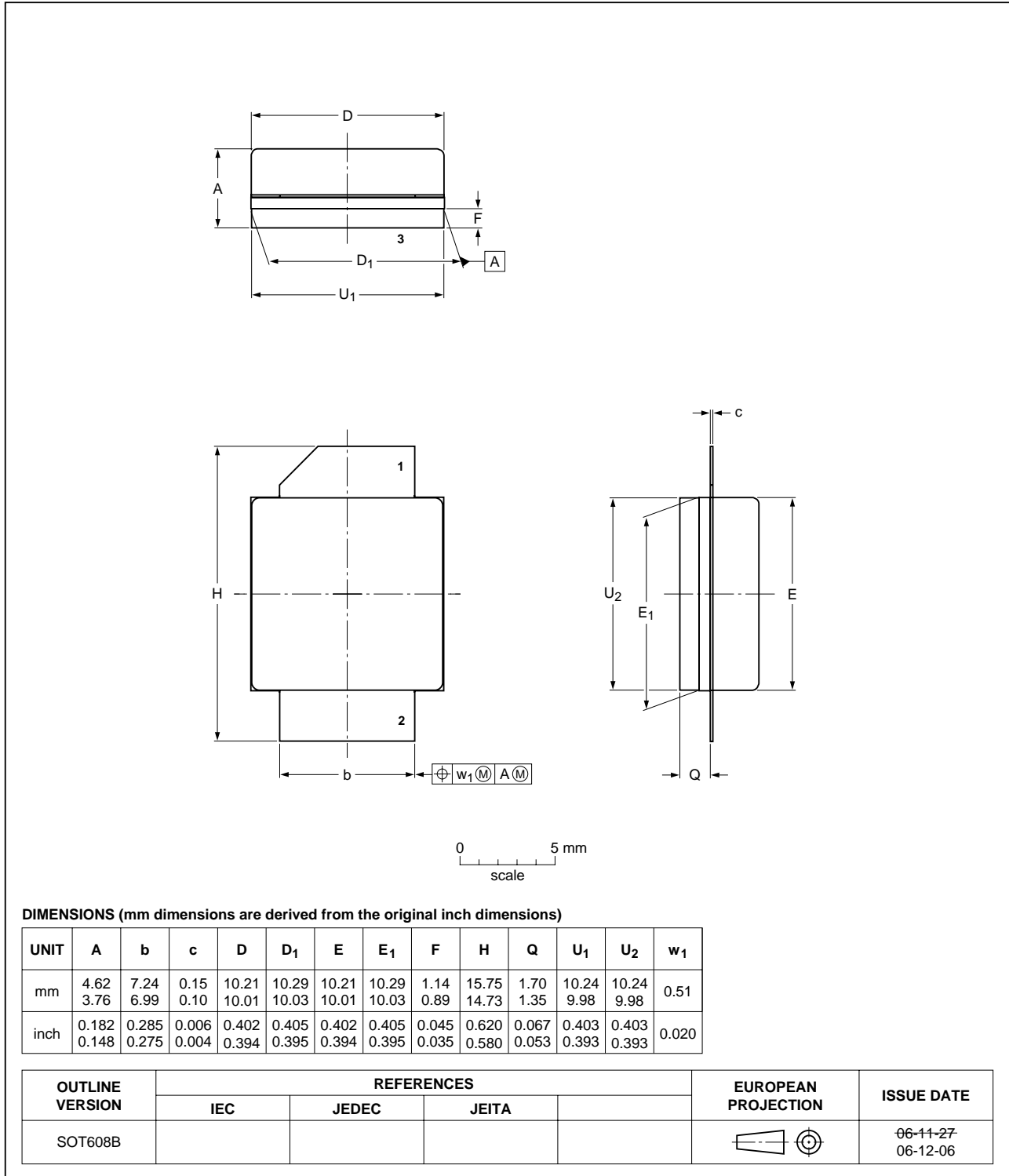

Fig 15. Package outline SOT608B

10. Abbreviations

Table 10. Abbreviations

Acronym	Description
CCDF	Complementary Cumulative Distribution Function
CW	Continuous Wave
LDMOS	Laterally Diffused Metal-Oxide Semiconductor
N-CDMA	Narrowband Code Division Multiple Access
PAR	Peak-to-Average power Ratio
RF	Radio Frequency
SMD	Surface Mounted Device
VSWR	Voltage Standing-Wave Ratio
WiMAX	Worldwide Interoperability for Microwave Access

11. Revision history

Table 11. Revision history

Document ID	Release date	Data sheet status	Change notice	Supersedes
BLF6G27-45_BLF6G27S-45_3	20081215	Product data sheet	-	BLF6G27-45_BLF6G27S-45_2
Modifications:		• Changed the maximum junction temperature in Table 4 on page 2 .		
BLF6G27-45_BLF6G27S-45_2	20080207	Preliminary data sheet	-	BLF6G27-45_BLF6G27S-45_1
BLF6G27-45_BLF6G27S-45_1	20080129	Preliminary data sheet	-	-

12. Legal information

12.1 Data sheet status

Document status ^{[1][2]}	Product status ^[3]	Definition
Objective [short] data sheet	Development	This document contains data from the objective specification for product development.
Preliminary [short] data sheet	Qualification	This document contains data from the preliminary specification.
Product [short] data sheet	Production	This document contains the product specification.

[1] Please consult the most recently issued document before initiating or completing a design.

[2] The term 'short data sheet' is explained in section "Definitions".

[3] The product status of device(s) described in this document may have changed since this document was published and may differ in case of multiple devices. The latest product status information is available on the Internet at URL <http://www.nxp.com>.

12.2 Definitions

Draft — The document is a draft version only. The content is still under internal review and subject to formal approval, which may result in modifications or additions. NXP Semiconductors does not give any representations or warranties as to the accuracy or completeness of information included herein and shall have no liability for the consequences of use of such information.

Short data sheet — A short data sheet is an extract from a full data sheet with the same product type number(s) and title. A short data sheet is intended for quick reference only and should not be relied upon to contain detailed and full information. For detailed and full information see the relevant full data sheet, which is available on request via the local NXP Semiconductors sales office. In case of any inconsistency or conflict with the short data sheet, the full data sheet shall prevail.

12.3 Disclaimers

General — Information in this document is believed to be accurate and reliable. However, NXP Semiconductors does not give any representations or warranties, expressed or implied, as to the accuracy or completeness of such information and shall have no liability for the consequences of use of such information.

Right to make changes — NXP Semiconductors reserves the right to make changes to information published in this document, including without limitation specifications and product descriptions, at any time and without notice. This document supersedes and replaces all information supplied prior to the publication hereof.

Suitability for use — NXP Semiconductors products are not designed, authorized or warranted to be suitable for use in medical, military, aircraft, space or life support equipment, nor in applications where failure or

malfunction of an NXP Semiconductors product can reasonably be expected to result in personal injury, death or severe property or environmental damage. NXP Semiconductors accepts no liability for inclusion and/or use of NXP Semiconductors products in such equipment or applications and therefore such inclusion and/or use is at the customer's own risk.

Applications — Applications that are described herein for any of these products are for illustrative purposes only. NXP Semiconductors makes no representation or warranty that such applications will be suitable for the specified use without further testing or modification.

Limiting values — Stress above one or more limiting values (as defined in the Absolute Maximum Ratings System of IEC 60134) may cause permanent damage to the device. Limiting values are stress ratings only and operation of the device at these or any other conditions above those given in the Characteristics sections of this document is not implied. Exposure to limiting values for extended periods may affect device reliability.

Terms and conditions of sale — NXP Semiconductors products are sold subject to the general terms and conditions of commercial sale, as published at <http://www.nxp.com/profile/terms>, including those pertaining to warranty, intellectual property rights infringement and limitation of liability, unless explicitly otherwise agreed to in writing by NXP Semiconductors. In case of any inconsistency or conflict between information in this document and such terms and conditions, the latter will prevail.

No offer to sell or license — Nothing in this document may be interpreted or construed as an offer to sell products that is open for acceptance or the grant, conveyance or implication of any license under any copyrights, patents or other industrial or intellectual property rights.

12.4 Trademarks

Notice: All referenced brands, product names, service names and trademarks are the property of their respective owners.

13. Contact information

For more information, please visit: <http://www.nxp.com>

For sales office addresses, please send an email to: salesaddresses@nxp.com

14. Contents

1	Product profile	1
1.1	General description	1
1.2	Features	1
1.3	Applications	2
2	Pinning information	2
3	Ordering information	2
4	Limiting values	2
5	Thermal characteristics	3
6	Characteristics	3
7	Application information	3
7.1	Ruggedness in class-AB operation	3
7.2	Single carrier N-CDMA performance	4
7.3	Two-tone	5
7.4	Continuous wave	6
7.5	Single carrier N-CDMA broadband per formance at 7 W average	7
7.6	Single carrier N-CDMA broadband performance at 20 W average	8
8	Test information	9
9	Package outline	12
10	Abbreviations	14
11	Revision history	14
12	Legal information	15
12.1	Data sheet status	15
12.2	Definitions	15
12.3	Disclaimers	15
12.4	Trademarks	15
13	Contact information	15
14	Contents	16

Please be aware that important notices concerning this document and the product(s) described herein, have been included in section 'Legal information'.



© NXP B.V. 2008.

All rights reserved.

For more information, please visit: <http://www.nxp.com>

For sales office addresses, please send an email to: salesaddresses@nxp.com

Date of release: 15 December 2008

Document identifier: BLF6G27-45_BLF6G27S-45_3