

PLEASE CHECK WWW.MOLEX.COM FOR LATEST PART INFORMATION

Part Number: [0353181820](#)
Status: **Active**
Overview: [minifit_jr](#)
Description: 4.20mm (.165") Pitch Mini-Fit® Header, Dual Row, Right Angle, 18 Circuits, PA Polyamide (Nylon) 6/6 94V-2, White

Documents:

[3D Model](#) [Product Specification PS-35317-001 \(PDF\)](#)
[Drawing \(PDF\)](#) [RoHS Certificate of Compliance \(PDF\)](#)

Agency Certification

CSA LR19980
 UL E29179

General

Product Family PCB Headers
 Series [35318](#)
 Application Wire-to-Board
 Comments Current = 13A max. per circuit when header is mated to a receptacle loaded with [45750](#) Mini-Fit Plus HCS™ Crimp Terminal Crimped to to 16 AWG wire. . See Molex product specification PS-45750-001 for additional current de-rating information.

Overview [minifit_jr](#)
 Product Name Mini-Fit®

Physical

Breakaway No
 Circuits (Loaded) 18
 Circuits (maximum) 18
 Color - Resin Natural
 Durability (mating cycles max) 30
 First Mate / Last Break No
 Flammability 94V-2
 Glow-Wire Compliant No
 Guide to Mating Part No
 Keying to Mating Part None
 Lock to Mating Part Yes
 Material - Plating Mating Tin
 Material - Plating Termination Tin
 Material - Resin Nylon
 Number of Rows 2
 Orientation Right Angle
 PC Tail Length (in) 0.157 In
 PC Tail Length (mm) 4.00 mm
 PCB Locator No
 PCB Retention None
 PCB Thickness Recommended (in) 0.062 In
 PCB Thickness Recommended (mm) 1.60 mm
 Packaging Type Bag
 Pitch - Mating Interface (in) 0.165 In
 Pitch - Mating Interface (mm) 4.20 mm
 Plating min: Mating (µin) 200
 Plating min: Mating (µm) 5
 Plating min: Termination (µin) 200
 Plating min: Termination (µm) 5

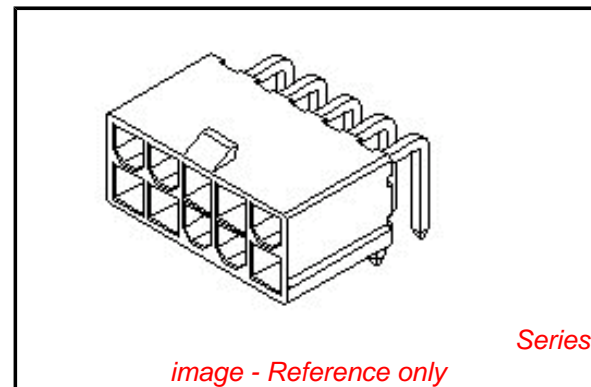

EU RoHS

ELV and RoHS Compliant
REACH SVHC
 Not Reviewed
Halogen-Free Status

China RoHS



Halogen-Free

Need more information on product environmental compliance?

Email productcompliance@molex.com
 For a multiple part number RoHS Certificate of Compliance, [click here](#)

Please visit the [Contact Us](#) section for any non-product compliance questions.

Search Parts in this Series

[35318Series](#)

Mates With

[5557](#) Mini-Fit Jr.™ Receptacle Housing

Polarized to PCB	No
Shrouded	Partial
Stackable	No
Surface Mount Compatible (SMC)	No
Temperature Range - Operating	-40°C to +105°C
Termination Interface: Style	Through Hole

Electrical

Current - Maximum per Contact	13A
Voltage - Maximum	250V

Material Info**Reference - Drawing Numbers**

Packaging Specification	PK-35318-001
Product Specification	PS-35317-001
Sales Drawing	SD-35318-****

This document was generated on 05/24/2010

PLEASE CHECK WWW.MOLEX.COM FOR LATEST PART INFORMATION

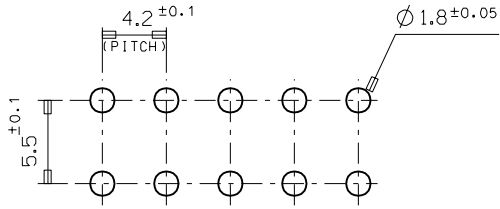
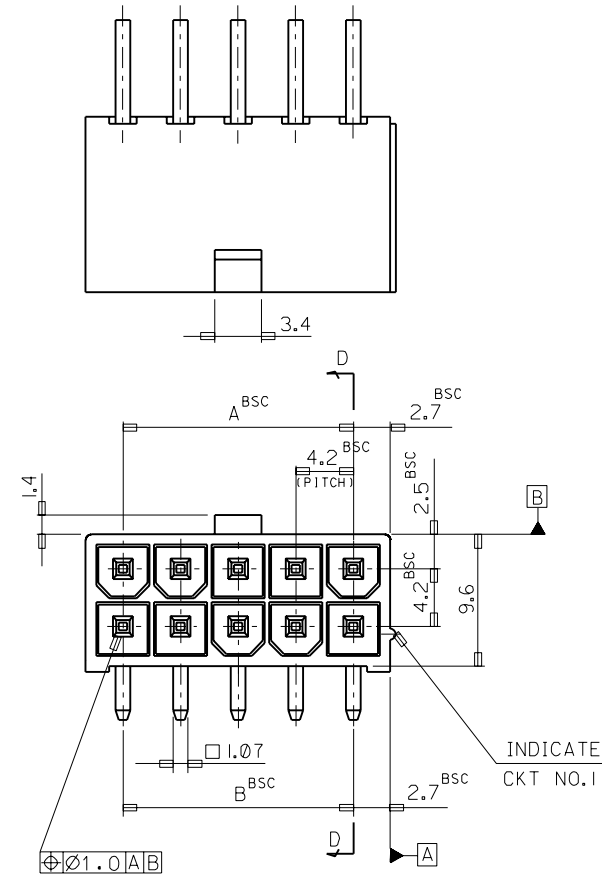

RECOMMENDED P.C. BOARD PATTERN

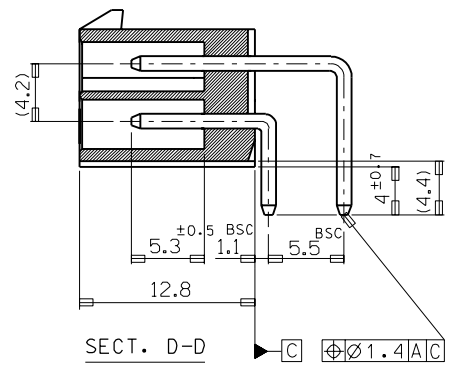

SECT. D-D

NOTES

1. WHEN MATED WITH 5557-NR, 5557-NR-210 TO BE SURELY LOCKED.
2. MATERIAL: WAFER — NYLON66 UL94V-0
NYLON66 UL94V-2
PIN — BRASS (TIN PLATED)

LEGEND

35318 - ** * *
 Ø: NATURAL
 I: BLACK
 1: NYLON66 UL94V-0
 2: NYLON66 UL94V-2
 CKT

46.2	46.2	35318	-24**	24
42.0	42.0		-22**	22
37.8	37.8		-20**	20
33.6	33.6		-18**	18
29.4	29.4		-16**	16
25.2	25.2		-14**	14
21.0	21.0		-12**	12
16.8	16.8		-10**	10
12.6	12.6		-08**	8
8.4	8.4		-06**	6
4.2	4.2	35318	-04**	4
A	B	ENG. NO.	CIRCUIT	

				MATERIAL		MOLEX MOLEX-KOREA CO., LTD.	
B	REVISED	96-022	96/2/26	GENERAL TOLERANCE DIMENSION : ± 0.3 ANGLE : ± 1°		DRAWN BY D. J. KIM	CHK'D BY
A	NEW RELEASED	94-074	94/12/20	DIMENSION CLASSIFICATION ▽ : CRITICAL ▼ : MAJOR () : REFERENCE		APP'D BY	SCALE 3/1
1	REVISED	94-017	94/9/7	ASS'Y PART		TITLE: NEW MINI FIT CONN. R/A WAFER ASS'Y	
0	PRE-RELEASED		93/5/1	DESCRIPTION ENG. NO.		SHEET	
LTR	REVISION RECORD	ECN	DATE	REVISE ONLY ON CAD SYSTEM		ENG. NO. SD-35318-****	
						REV B	