

**PLEASE CHECK WWW.MOLEX.COM FOR LATEST PART INFORMATION**

**Part Number:** **0190190005**  
**Status:** **Active**  
**Description:** Avikrimp™ Quick Disconnect, Female, for 18-22 (0.80-0.35) Wire, Mylar Tape, Tab 2.79mm (.110") x 0.81mm (.032")

**Documents:**

[Drawing \(PDF\)](#) [RoHS Certificate of Compliance \(PDF\)](#)

**Agency Certification**

CSA LR18689  
 UL E79133

**General**

Product Family Quick Disconnects  
 Series [19019](#)  
 Crimp Quality Equipment Yes  
 Product Name Avikrimp™  
 Type Quick Disconnect

**Physical**

Barrel Type Closed  
 Flammability 94V-0  
 Gender Female  
 Glow-Wire Compliant No  
 Insulation Nylon (PA)  
 Lock to Mating Part None  
 Material - Metal Brass  
 Material - Plating Mating Tin  
 Material - Plating Termination Tin  
 Orientation Straight  
 Packaging Type Adhesive Tape on Reel  
 Plating min: Mating (µin) 160  
 Plating min: Mating (µm) 4  
 Plating min: Termination (µin) 160  
 Plating min: Termination (µm) 4  
 Polarized to Mating Part No  
 Tab Thickness 0.81mm (.032")  
 Tab Width 2.79mm (.110")  
 Temperature Range - Operating -65°C to +105°C  
 Termination Interface: Style Crimp or Compression  
 Wire Insulation Diameter 2.90mm (.115") max.  
 Wire Size AWG 18, 20, 22  
 Wire Size mm² 0.35 - 0.80

**Electrical**

Voltage - Maximum 300V

**Material Info**

Old Part Number AA-8134T

**Reference - Drawing Numbers**

Sales Drawing SD-19019-001



**EU RoHS**

**ELV and RoHS Compliant**  
**REACH SVHC**  
 Not Reviewed  
**Halogen-Free Status**  
 Not Reviewed

**China RoHS**



**Need more information on product environmental compliance?**

Email [productcompliance@molex.com](mailto:productcompliance@molex.com)  
 For a multiple part number RoHS Certificate of Compliance, [click here](#)

Please visit the [Contact Us](#) section for any non-product compliance questions.

**Search Parts in this Series**

[19019Series](#)

**Application Tooling | [FAQ](#)**

*Tooling specifications and manuals are found by selecting the products below. Crimp Height Specifications are then contained in the Application Tooling Specification document.*

**Global**

Description	Product #
Crimp Dies for MTA-100 Tape Applicator used in 3BF Press, MTA-105 Tape Applicator used in TM-2000™ Press, and ATP-301 Air Crimping Press for Mylar Tape Mounted Terminals	<a href="#">0192880048</a>
Mini-Mac™ Applicator	<a href="#">0638850800</a>

This document was generated on 04/13/2010

**PLEASE CHECK [WWW.MOLEX.COM](http://WWW.MOLEX.COM) FOR LATEST PART INFORMATION**

LOOSE PIECE		TAPE MOUNTED		CONTINUOUS STRIP (C)		SPECIFICATIONS											
MATERIAL NUMBER	ENGINEERING NUMBER	MATERIAL NUMBER	ENGINEERING NUMBER	MATERIAL NUMBER	ENGINEERING NUMBER	INS. COLOR	WIRE AWG	RANGE	MM <sup>2</sup>	FITS MALE TAB SIZE	STOCK THICKNESS	"L" MAX.	"I" MAX.	"W" MAX.	"D" ±.01	"G" NOM.	MWID
190190012	AA-8140	190190013	AA-8140T	190190020	AAZ-8140	RED	22-18	0.25-1.5	.250x.032 (6.35x0.81)	.016 (0.41)	.865 (21.97)	.43 (10.9)	.301 (7.65)	.156 (3.96)	.31 (7.9)	.115 (2.92)	
190190031	BB-8141	190190033	BB-8141T	190190036	BBZ-8141	BLUE	16-14	1.0-2.5	.250x.032 (6.35x0.81)	.016 (0.41)	.865 (21.97)	.43 (10.9)	.301 (7.65)	.156 (3.96)	.31 (7.9)	.138 (3.51)	
190190052	P-8142	190190054	P-8142T	190190057	PZ-8142	YELLOW	14-12	1.65-4.2	.250x.032 (6.35x0.81)	.016 (0.41)	.865 (21.97)	.43 (10.9)	.301 (7.65)	.156 (3.96)	.31 (7.9)	.170 (4.32)	
190190037	C-8143	190190038	C-8143T	-	-	YELLOW	10-12	4.0-6.0	.250x.032 (6.35x0.81)	.018 (0.46)	1.011 (25.68)	.57 (14.5)	.301 (7.65)	.156 (3.96)	.31 (7.9)	.225 (5.70)	
190190014	AA-8190	190190016	AA-8190T	190190021	AAZ-8190	RED	22-18	0.25-1.5	.205x.020 (5.21x0.51)	.016 (0.41)	.789 (20.04)	.43 (10.9)	.251 (6.38)	.125 (3.18)	.25 (6.4)	.115 (2.92)	
190190034	BB-8191	190190064	BB-8191T	-	-	BLUE	16-14	1.0-2.5	.205x.020 (5.21x0.51)	.016 (0.41)	.789 (20.04)	.43 (10.9)	.251 (6.38)	.125 (3.18)	.25 (6.4)	.115 (2.92)	
190190015	AA-8190-032	190190058	AA-8190-032T	-	-	RED	22-18	0.25-1.5	.205x.032 (5.21x0.81)	.016 (0.41)	.789 (20.04)	.43 (10.9)	.251 (6.38)	.125 (3.18)	.25 (6.4)	.115 (2.92)	
190190035	BB-8191-032	190190063	BB-8191-032T	-	-	BLUE	16-14	1.0-2.5	.205x.032 (5.21x0.81)	.016 (0.41)	.789 (20.04)	.43 (10.9)	.251 (6.38)	.125 (3.18)	.25 (6.4)	.115 (2.92)	
190190008	AA-8137-032	190190009	AA-8137-032T	190190019	AAZ-8137-032	RED	22-18	0.25-1.5	.187x.032 (4.75x0.81)	.016 (0.41)	.789 (20.04)	.43 (10.9)	.238 (6.05)	.125 (3.18)	.25 (6.4)	.138 (3.51)	
190190028	BB-8138-032	190190029	BB-8138-032T	190190080	BBZ-8138-032	BLUE	16-14	1.0-2.5	.187x.032 (4.75x0.81)	.016 (0.41)	.789 (20.04)	.43 (10.9)	.238 (6.05)	.125 (3.18)	.25 (6.4)	.138 (3.51)	
190190049	P-8139-032	190190050	P-8139-032T	190190056	PZ-8139-032	YELLOW	14-12	1.65-4.2	.187x.032 (4.75x0.81)	.016 (0.41)	.789 (20.04)	.43 (10.9)	.238 (6.05)	.125 (3.18)	.25 (6.4)	.170 (4.32)	
190190006	AA-8137	190190011	AA-8137T	190190018	AAZ-8137	RED	22-18	0.25-1.5	.187x.020 (4.75x0.51)	.016 (0.41)	.789 (20.04)	.43 (10.9)	.238 (6.05)	.125 (3.18)	.25 (6.4)	.115 (2.92)	
190190027	BB-8138	190190030	BB-8138T	190190079	BBZ-8138	BLUE	16-14	1.0-2.5	.187x.020 (4.75x0.51)	.016 (0.41)	.789 (20.04)	.43 (10.9)	.238 (6.05)	.125 (3.18)	.25 (6.4)	.138 (3.51)	
190190048	P-8139	190190051	P-8139T	190190055	PZ-8139	YELLOW	14-12	1.65-4.2	.187x.020 (4.75x0.51)	.016 (0.41)	.789 (20.04)	.43 (10.9)	.238 (6.05)	.125 (3.18)	.25 (6.4)	.170 (4.32)	
190190004	AA-8134	190190005	AA-8134T	190190075	AAZ-8134	RED	22-18	0.25-1.5	.110x.032 (2.80x0.81)	.012 (0.30)	.789 (20.04)	.43 (10.9)	.163 (4.14)	.210 (5.33)	.25 (6.4)	.115 (2.92)	
190190025	BB-8135	190190026	BB-8135T	190190078	BBZ-8135	BLUE	16-14	1.0-2.5	.110x.032 (2.80x0.81)	.012 (0.30)	.789 (20.04)	.43 (10.9)	.163 (4.14)	.210 (5.33)	.25 (6.4)	.138 (3.51)	
190190001	AA-8131	190190003	AA-8131T	190190017	AAZ-8131	RED	22-18	0.25-1.5	.110x.020 (2.80x0.51)	.012 (0.30)	.789 (20.04)	.43 (10.9)	.163 (4.14)	.210 (5.33)	.25 (6.4)	.115 (2.92)	
190190022	BB-8132	190190024	BB-8132T	190190076	BBZ-8132	BLUE	16-14	1.0-2.5	.110x.020 (2.80x0.51)	.012 (0.30)	.789 (20.04)	.43 (10.9)	.163 (4.14)	.210 (5.33)	.25 (6.4)	.138 (3.51)	

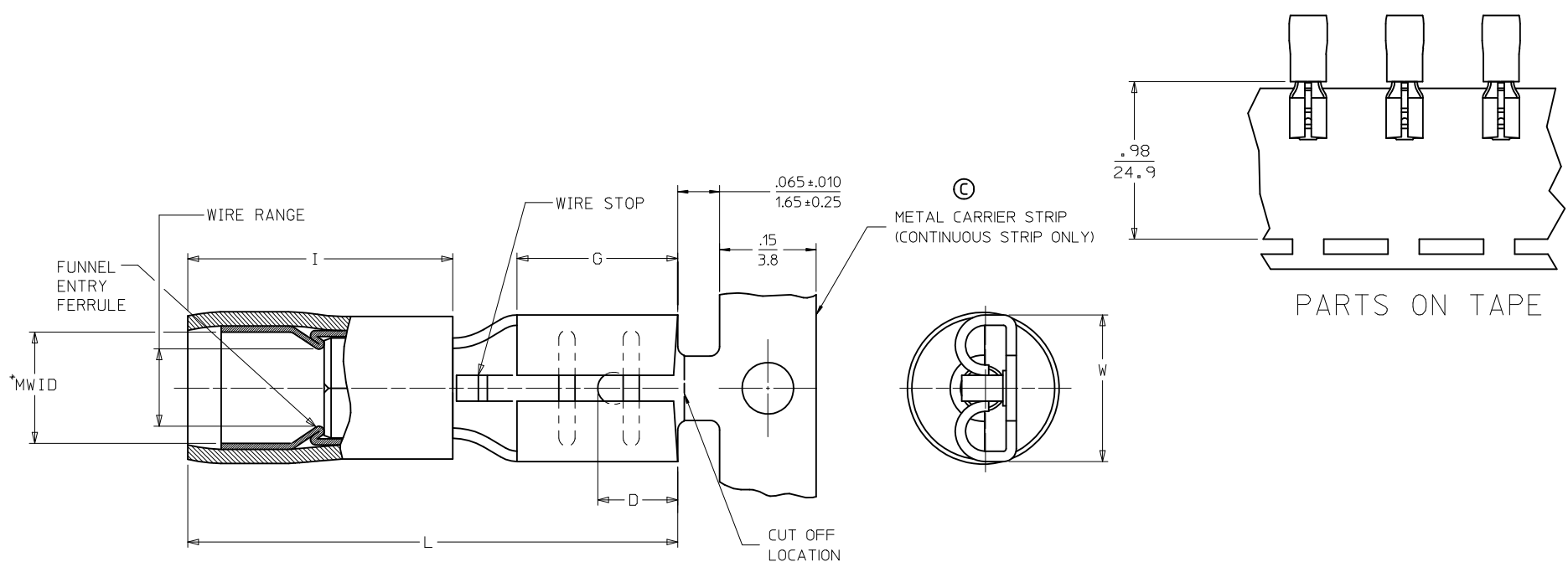

- NOTES:
1. MATERIAL: BRASS TERMINAL, COPPER ALLOY FERRULE
  2. FINISH: ELECTRO-TIN PLATING
  3. INSULATION: EXTRUDED NYLON
  - 4.\*MWID=MAXIMUM WIRE INSULATION DIAMETER
  5. PARTS ARE ROHS COMPLIANT.

<b>FERRULE DESCR. CONT P/N</b> EC NO: MNA2009-0510 DRW: NETHRODAHL 2010/01/04 CHKD: JMACNEIL 2010/01/05 APPR: JMACNEIL 2010/01/05	<b>QUALITY SYMBOLS</b> ▽=0 ▽=0	<b>GENERAL TOLERANCES (UNLESS SPECIFIED)</b>		<b>DIMENSION STYLE</b> IN/MM	<b>SCALE</b> ---	<b>DESIGN UNITS</b> INCH	THIRD ANGLE PROJECTION	
		4 PLACES ± --- ± ---	3 PLACES ± --- ± .005	DRAWN BY BRE	DATE 2001/07/25	<b>TITLE</b> QUICK DISCONNECT PARTIALLY INSULATED AVIKRIMP		
		2 PLACES ± 0.13 ± .01	1 PLACE ± 0.25 ± ---	CHECKED BY HEB	DATE 2001/07/25	<b>MOLEX INCORPORATED</b>		
		ANGULAR ± ---°		APPROVED BY RWD	DATE 2001/07/25	MATERIAL NO. <b>SEE CHART</b>	DOCUMENT NO. SD-19019-001	SHEET NO. 1 OF 1

DRAFT WHERE APPLICABLE MUST REMAIN WITHIN DIMENSIONS

THIS DRAWING CONTAINS INFORMATION THAT IS PROPRIETARY TO MOLEX INCORPORATED AND SHOULD NOT BE USED WITHOUT WRITTEN PERMISSION