

MJTP SERIES ULTRA-MINIATURE TACT SWITCHES

FEATURES

- Numerous single pole-single throw momentary configurations.
- Excellent tactile feed-back (Snap dome).
- Ultra-compact size.
- Long operating life for high reliability.
- Thru-hole and surface mount models available.
- Molded-in terminals minimize wicking of flux or solder.

MATERIALS

Case: Thermoplastic, color black.
 Actuator: Thermoplastic, color black unless otherwise specified.
 Cover/Bracket: PET film, tin plated brass or stainless steel.
 Terminals: Silver plated brass.
 Shorting Contact: Phosphor bronze or stainless steel with silver plating.
 L.E.D. rating: Forward voltage- 2.1 V (3.0 V Max.). Cont. forward current 20mA max. @ 25°C.

SPECIFICATIONS SUBJECT TO CHANGE WITHOUT NOTICE.

GENERAL SPECIFICATIONS	
ELECTRICALS	
Contact rating:	50 mA @ 12 VDC
Insulation resistance:	100 megohms min. (100 VDC)
Dielectric withstanding voltage:	250 VAC for 1 minute
Contact resistance:	100 milliohms max. @ 5 VDC, 10 mA
Electrical life:	100,000 cycles min. (except models MJTP1243 & 1250- 50,000 cycles).
Contact bounce:	less than 10 msec.
MECHANICALS, THERMALS, ENVIRONMENTALS	
Plunger travel:	.010" + .008", - .004" (0,25 +0,2, -0,1 mm)
Actuation force:	160 grams ±30 grams
Operating temperature range:	-20°C to +70°C
Storage temperature range:	-30°C to +80°C for 96 hours
Shock resistance:	30G per method 205, MIL-STD-202
Vibration resistance:	passes method 201, MIL-STD-202
SOLDERING (note - not solvent washable)	
IR reflow soldering:	240°C max. for 20 seconds max.
Wave soldering:	255°C max. for 5 seconds max.
Hand soldering:	320°C max. for 3.5 seconds max. (40 watt iron max.)

MJTP1105T Right angle, thru-hole mtg., grounding, blue actuator



New!

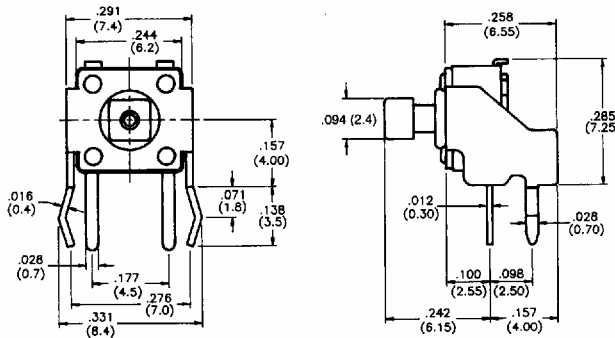

MJTP1122 Surface mtg., green actuator, grounding



New!

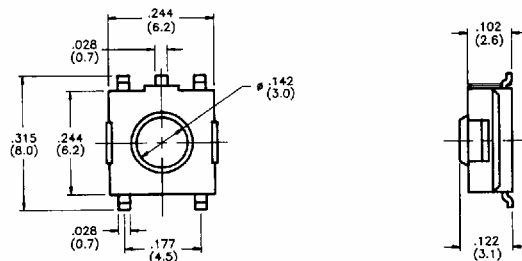

Sealed models available - tape & reel packaging available - consult factory.

SPECIFICATIONS SUBJECT TO CHANGE WITHOUT NOTICE.

MJTP1122A
Surface mtg.,
black actuator, grounding

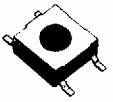

New!

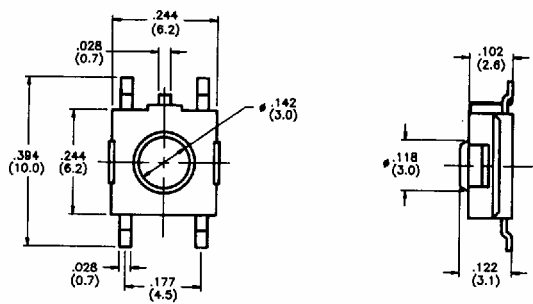

Sealed models available - tape & reel packaging available - consult factory.

MJTP1122B
Surface mtg.,
red actuator



New!

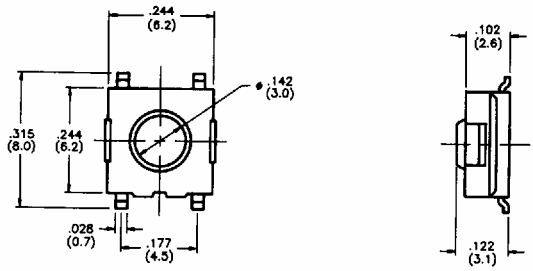

Sealed models available - tape & reel packaging available - consult factory.

MJTP1137
Surface mtg.,
black actuator



New!

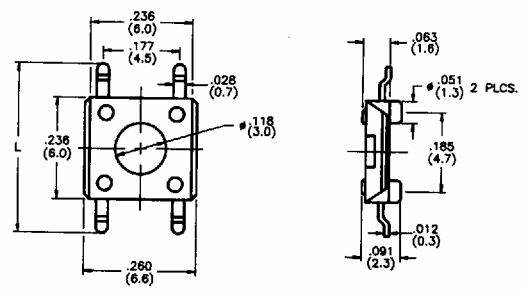

Sealed models available - tape & reel packaging available - consult factory.

Model No.	Dim. L
MJTP1137	.315 (8,0)
MJTP1137A	.394 (10,0)

MJTP1194
Thru-hole mtg. with L.E.D.



New!

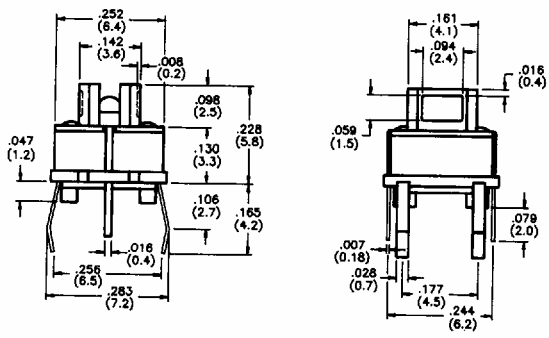

Model No.	L.E.D. Color
MJTP1194	No L.E.D.
MJTP1194R	Red
MJTP1194Y	Yellow
MJTP1194G	Green
MJTP1194W	White

MJTP1230
Thru-hole mtg.,
black actuator

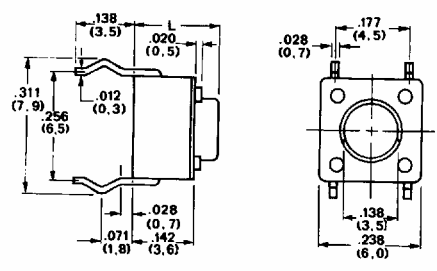

Model No.	Dim. L
MJTP1230	.170 (4,3)
MJTP1230A	.197 (5,0)
MJTP1230B	.374 (9,5)
MJTP1230C	.315 (8,0)
MJTP1230D	.512 (13,0)
MJTP1230E	.287 (7,3)
MJTP1230F	.335 (8,5)
MJTP1230G	.275 (7,0)

Actuator colors: Black, except 1230C is white, 1230E is ivory and 1230F is gray.

F

SPECIFICATIONS SUBJECT TO CHANGE WITHOUT NOTICE.

MJTP1232
Thru-hole mtg.,
grounding

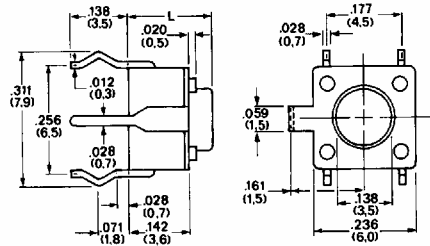

Model No.	Dim. L
MJTP1232	.170 (4,3)
MJTP1232A	.197 (5,0)
MJTP1232B	.374 (9,5)
MJTP1232C	.315 (8,0)
MJTP1232D	.512 (13,0)
MJTP1232E	.287 (7,3)

Actuator color: black - except 1232C is white & 1232E is ivory

MJTP1234
Thru-hole mtg.

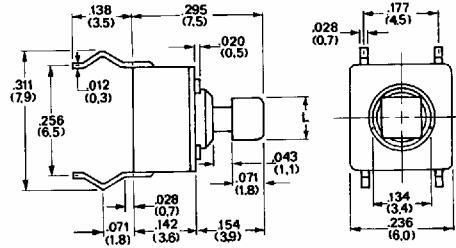

Model No.	Dim. L
MJTP1234	.094 (2,4)
MJTP1234A	.110 (2,8)

Actuator color: 1234 - blue
1234A - black

Caps available - consult factory.

MJTP1236
Right angle, thru-hole mtg.,
grounding, black actuator

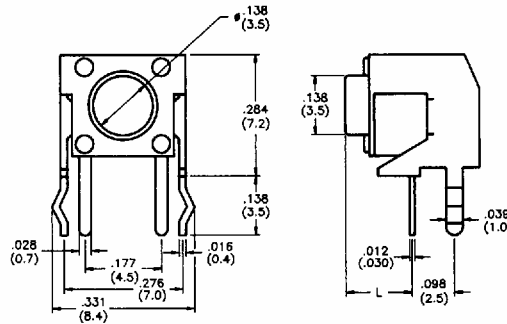

Model No.	Dim. L
MJTP1236	.124 (3,1)
MJTP1236A	.152 (3,9)
MJTP1236B	.329 (8,4)
MJTP1236C	.270 (6,9)
MJTP1236D	.466 (11,9)
MJTP1236E	.230 (5,8)

MJTP1243 & MJTP1250
Thru-hole mtg.

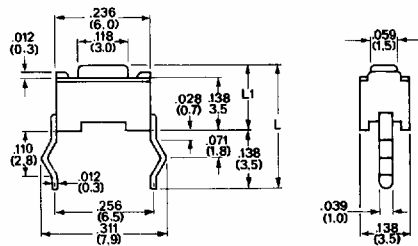

Model No.	Dim. L1	Dim. L
MJTP1243	.169 (4,3)	.307 (7,8)
MJTP1250	.197 (5,0)	.335 (8,5)

Actuator color: 1243 - black
1250 - white

MJTP2205
2 switch vert. gang
ass'y., black actuators



New!

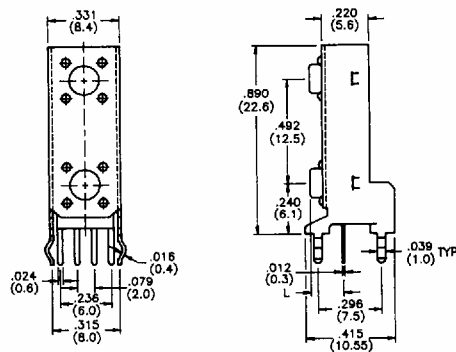

Model No.	Dim. L
MJTP2205	.124 (3,15)
MJTP2205A	.152 (3,85)
MJTP2205B	.329 (8,35)
MJTP2205C	.270 (6,85)
MJTP2205D	.466 (11,85)
MJTP2205E	.242 (6,15)

MJTP4102
4 switch hor. gang ass'y.,
black actuators

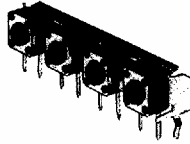

New!

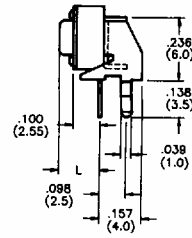
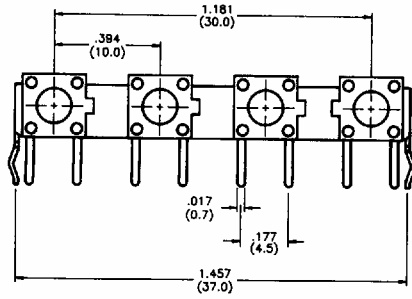

Model No.	Dim. L
MJTP4102	.125 (3,2)
MJTP4102A	.152 (3,85)
MJTP4102B	.329 (8,35)

MJTP5302
5 switch hor. gang ass'y.,
black actuators

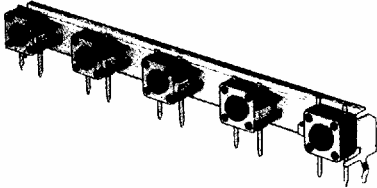

New!

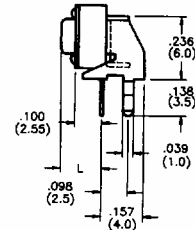
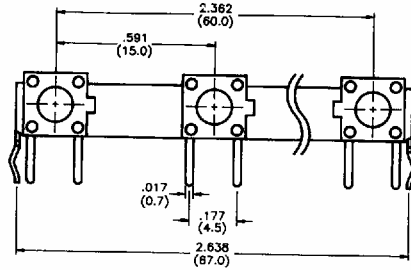

Model No.	Dim. L
MJTP5302	.125 (3,2)
MJTP5302A	.152 (3,85)
MJTP5302B	.329 (8,35)

SCHEMATICS

Note-schematics for MJTP2205, 4102 & 5302 same as MJTP1122 except x2, x4 & x5 respectively.

MJTP1122,
MJTP1137,
MJTP1194,
MJTP1230,
MJTP1232 &
MJTP1234
(L.E.D. for MJTP1194 only)

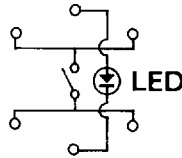

MJTP1105T,
MJTP1236,
MJTP1243 &
MJTP1250

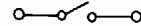

PRINTED CIRCUIT BOARD LAYOUTS

Layout Tolerances; Linear: ± .004" (± 0,1mm) Holes: ± .002" (± 0,05mm) Pads: ± .008" (± 0,2mm)

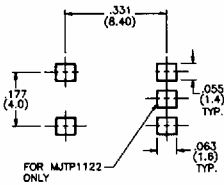

MJTP1122 & 1122B

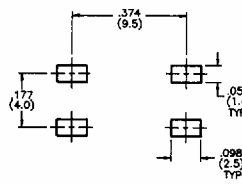

MJTP1122A

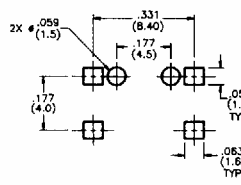

MJTP1137

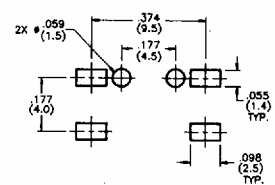

MJTP1137A

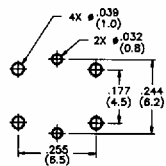

MJTP1194

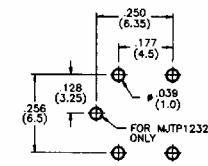

MJTP1230, 1232 & 1234

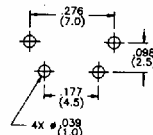

MJTP1105T & 1236

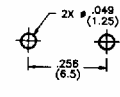

MJTP1243 & 1250

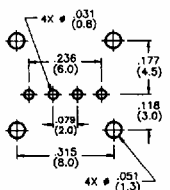

MJTP2205

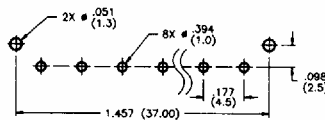

MJTP4102

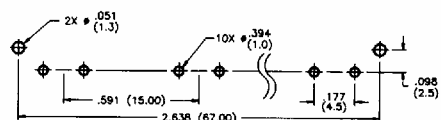

MJTP5302

96E 6346802 0001432 520