

## 300mA High PSRR, Low-Noise LDO Regulators

### Features

- Ultra Low Output Noise—30 $\mu$ V (rms)
- Ultra Low 55 $\mu$ A No-Load Supply Current
- Ultra Low Dropout 70mV @ 50mA Load
- Guarantee 300mA Output Current
- Over-Temperature and Short-Circuit Protection
- Fixed Mode: 2.70V (G914A), 2.80V (G914B)  
3.00V (G914C), 3.30V (G914D)  
2.50V (G914E), 2.85V (G914F)  
1.50V (G914G), 1.80V (G914H)
- Adjustable Mode: from 1.25V to 5.50V (G914Z)
- PSRR=70dB
- Max. Supply Current in Shutdown Mode < 1 $\mu$ A
- Stable with low cost ceramic capacitors

### General Description

The G914X is a low supply current, high PSRR low dropout linear regulator that comes in a space saving SOT-23-5 package. The supply current at no-load is 55 $\mu$ A. In the shutdown mode, the maximum supply current is less than 1 $\mu$ A. Operating voltage range of the G914X is from 2.5V to 5.5V. The over-current protection limit is set at 500mA typical and 400mA minimum. An over-temperature protection circuit is built-in in the G914X to prevent thermal overload. These power saving features make the G914X ideal for use in the battery-powered applications such as notebook computers, cellular phones, and PDA's.

### Applications

- Notebook Computers
- Cellular Phones
- PDA
- Hand-Held Devices
- Battery-Powered Application

### Ordering Information

ORDER NUMBER	ORDER NUMBER (Pb free)	MARKING	VOLTAGE	TEMP. RANGE	PACKAGE
G914A	G914Af	4Axx	2.70V	-40°C~ +85°C	SOT-23-5
G914B	G914Bf	4Bxx	2.80V	-40°C~ +85°C	SOT-23-5
G914C	G914Cf	4Cxx	3.00V	-40°C~ +85°C	SOT-23-5
G914D	G914Df	4Dxx	3.30V	-40°C~ +85°C	SOT-23-5
G914E	G914Ef	4Exx	2.50V	-40°C~ +85°C	SOT-23-5
G914F	G914Ff	4Fxx	2.85V	-40°C~ +85°C	SOT-23-5
G914G	G914Gf	4Gxx	1.50V	-40°C~ +85°C	SOT-23-5
G914H	G914Hf	4Hxx	1.80V	-40°C~ +85°C	SOT-23-5
G914Z	G914Zf	4Zxx	Adjustable	-40°C~ +85°C	SOT-23-5

### Pin Configuration

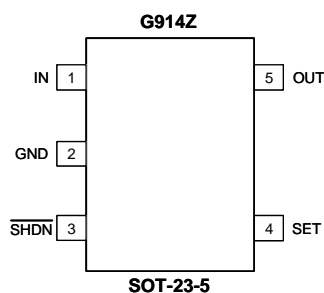
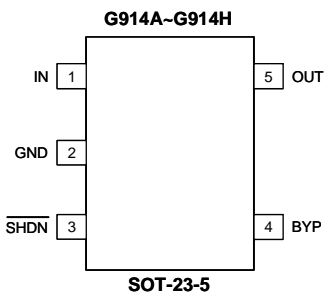

### Typical Application Circuit

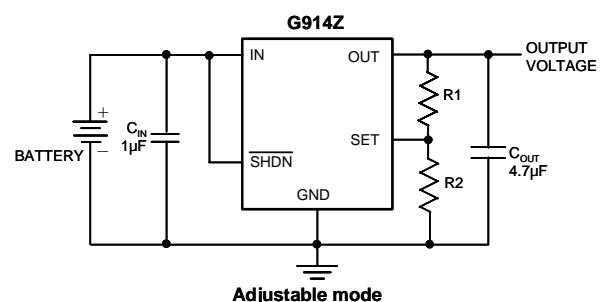
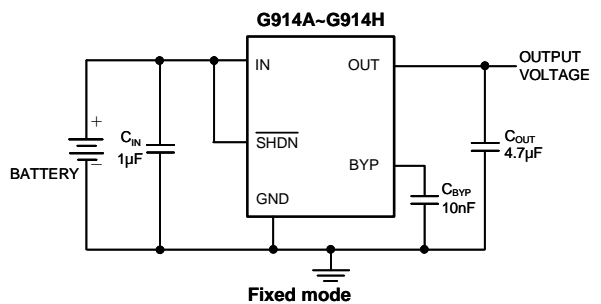

## Absolute Maximum Ratings

$V_{IN}$  to GND. . . . . -0.3V to +7V  
 Output Short-Circuit Duration. . . . . Infinite  
 All Other Pins to GND. . . . . -0.3V to ( $V_{IN} + 0.3V$ )  
 Thermal Resistance Junction to Ambient, ( $\theta_{JA}$ )  
 SOT-23-5. . . . . 240°C/W

Operating Temperature Range. . . . . -40°C to +85°C  
 Junction Temperature. . . . . +150°C  
 Storage Temperature Range. . . . . -65°C to +160°C  
 Reflow Temperature (soldering, 10sec) . . . . . 260°C

Note <sup>(1)</sup>: See Recommended Minimum Footprint

Stresses beyond those listed under "Absolute Maximum Ratings" may cause permanent damage to the device. These are stress ratings only, and functional operation of the device at these or any other conditions beyond those indicated in the operational sections of the specifications is not implied. Exposure to absolute maximum rating conditions for extended periods may affect device reliability.

## Electrical Characteristics

( $V_{IN}=V_{OUT(STD)}+1V$ ,  $V_{SHDN}=V_{IN}$ ,  $T_A=T_J=25^\circ C$ , unless otherwise noted.) (Note 1)

PARAMETER	SYMBOL	CONDITIONS	MIN	TYP	MAX	UNITS	
Input Voltage (Note 2)	$V_{IN}$		Note2	---	5.5	V	
Output Voltage Accuracy	$V_{OUT}$	Variation from specified $V_{OUT}$ , $I_{OUT}=1mA$ , $V_{OUT}\geq 2.5V$ version	-2	---	2	%	
		For G914H, $I_{OUT}=1mA$	-3	---	3		
		For G914G, $I_{OUT}=1mA$	-4	---	4		
Maximum Output Current			---	300	---	mA	
Current Limit (Note 3)	$I_{LIM}$		---	500	---	mA	
Ground Pin Current	$I_Q$	$V_{IN}=3.6V$	$I_{LOAD} = 0mA$	---	55	120	$\mu A$
			$I_{LOAD} = 50mA$	---	145	---	
			$I_{LOAD} = 300mA$	---	265	---	
Dropout Voltage (Note 4)	$V_{DROP}$	$I_{OUT} = 1mA$		---	2	---	mV
			$I_{OUT} = 50mA$ , $V_{OUT} \geq 2.7V$ Version	---	70	---	
		$I_{OUT} = 150mA$	$V_{O(NOM)} \geq 3.0V$	---	230	---	
			$2.5V \leq V_{O(NOM)} \leq 2.85V$	---	250	---	
		$I_{OUT} = 300mA$	$V_{O(NOM)} = 1.8V$	---	380	---	
			$V_{O(NOM)} = 1.5V$	---	510	---	
			$V_{O(NOM)} \geq 3.0V$	---	450	600	
			$2.5V \leq V_{O(NOM)} \leq 2.85V$	---	500	660	
		$V_{O(NOM)} = 1.8V$	---	760	1500		
		$V_{O(NOM)} = 1.5V$	---	910	1800		
Line Regulation	$\Delta V_{LNR}$	$V_{IN}=V_{OUT}+100mV$ to 5.5V, $I_{OUT} = 1mA$	---	0.1	0.28	%/V	
Load Regulation (Note 5)	$\Delta V_{LDR}$	$I_{OUT} = 10mA$ to 300mA	---	0.1	1	%	
Power Supply Rejection Ratio	PSRR	$I_{OUT} = 10mA$ $C_{BYP} = 10nF$ , $f = 120HZ$	---	70	---	dB	
Output Voltage Temperature Coefficient	$\Delta V_O / \Delta T$	$I_{OUT} = 50mA$ , $T_J = 25^\circ C$ to $125^\circ C$	---	30	---	ppm/ $^\circ C$	
Output Voltage Noise (10Hz to 100kHz) (G914H)	$e_n$	$V_{IN}=V_{OUT}+1V$	$C_{OUT} = 1\mu F$ , $I_{OUT} = 150mA$ , $C_{BYP}=1nF$	---	52	---	$\mu V_{RMS}$
			$C_{OUT} = 1\mu F$ , $I_{OUT} = 150mA$ , $C_{BYP}=10nF$	---	35	---	
			$C_{OUT} = 1\mu F$ , $I_{OUT} = 150mA$ , $C_{BYP} = 100nF$	---	30	---	
			$C_{OUT} = 1\mu F$ , $I_{OUT} = 1mA$ , $C_{BYP} = 10nF$	---	26	---	

## Electrical Characteristics

( $V_{IN}=V_{OUT(STD)}+1V$ ,  $V_{\overline{SHDN}}=V_{IN}$ ,  $T_A=T_J=25^\circ C$ , unless otherwise noted.)

PARAMETER	SYMBOL	CONDITIONS	MIN	TYP	MAX	UNITS
<b>SHUTDOWN</b>						
$\overline{SHDN}$ Input Threshold	$V_{IH}$	Regulator enabled	15	---	---	V
	$V_{IL}$	Regulator shutdown	---	---	0.4	
$\overline{SHDN}$ Input Bias Current	$I_{SHDN}$	$V_{\overline{SHDN}} = V_{IN}$ $T_A = +25^\circ C$	---	0.003	0.1	$\mu A$
Shutdown Supply Current	$I_{Q\ SHDN}$	$V_{OUT} = 0V$ $T_A = +25^\circ C$	---	---	1	
<b>THERMAL PROTECTION</b>						
Thermal Shutdown Temperature	$T_{SHDN}$		---	150	---	$^\circ C$
Thermal Shutdown Hysteresis	$\Delta T_{SHDN}$		---	15	---	$^\circ C$
<b>SET INPUT</b>						
SET Reference Voltage	$V_{SET}$	$V_{IN} = 2.5V$ to $5.5V$ , $I_{OUT} = 1mA$	1.225	1.25	1.275	V
SET Input Leakage Current	$I_{SET}$	$V_{SET} = 1.3V$	---	5	30	nA

Note 1: Limits is 100% production tested at  $T_A = +25^\circ C$ . Low duty pulse techniques are used during test to maintain junction temperature as close to ambient as possible.

Note 2:  $V_{IN(min)} = V_{OUT(STD)} + V_{DROPOUT}$

Note 3: Not tested. For design purposes, the current limit should be considered 400mA minimum to 600mA maximum.

Note 4: The dropout voltage is defined as  $(V_{IN} - V_{OUT})$  when  $V_{OUT}$  is 100mV below the value of  $V_{OUT}$  for  $V_{IN} = V_{OUT} + 1V$ . The performance of every G914X version, see "Typical Performance Characteristics".

Note 5: Regulation is measured at constant junction temperature using low duty cycle pulse testing. Parts are tested for load regulation in the load range from 1mA to 300mA. Changes in output due to heating effects are covered by the thermal regulation specification.

**Typical Performance Characteristics**

( $V_{IN} = V_{O} + 1V$ ,  $C_{IN} = 1\mu F$ ,  $C_{OUT} = 1\mu F$ ,  $V_{SHDN} = V_{IN}$ , G914D,  $T_A = 25^\circ C$ , unless otherwise noted.)

**Output Voltage vs. Load Current**

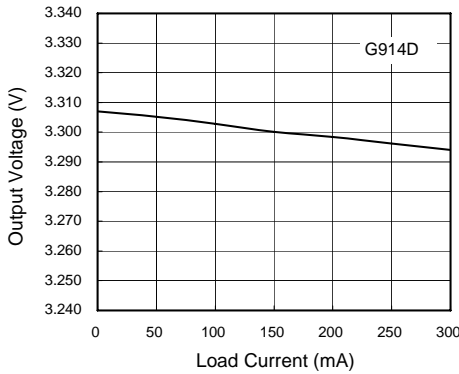

**Ground Current vs. Load Current**

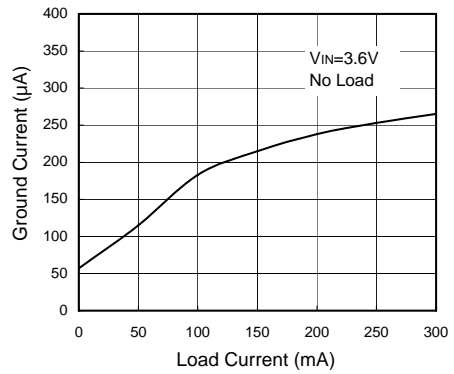

**Output Voltage vs. Input Voltage**

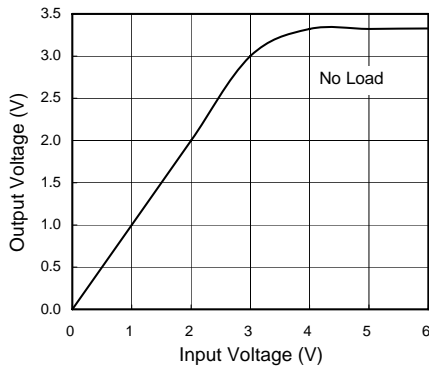

**Supply Current vs. Input Voltage**

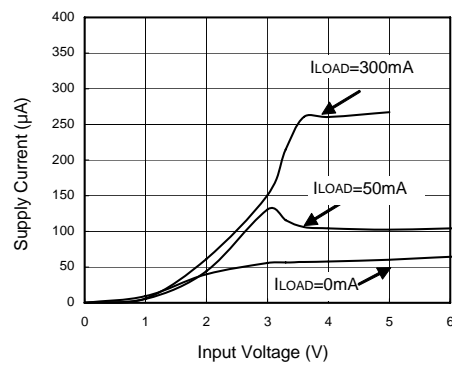

**Dropout Voltage vs. Load Current**

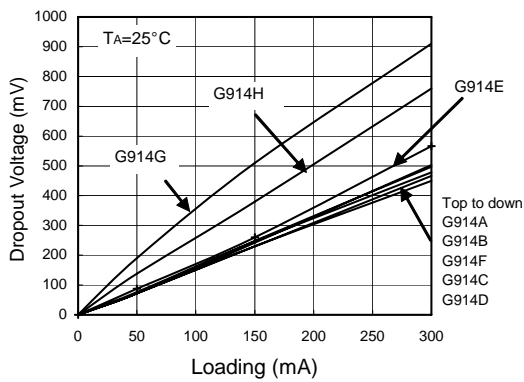

**Output Noise 10HZ to 100KHZ**

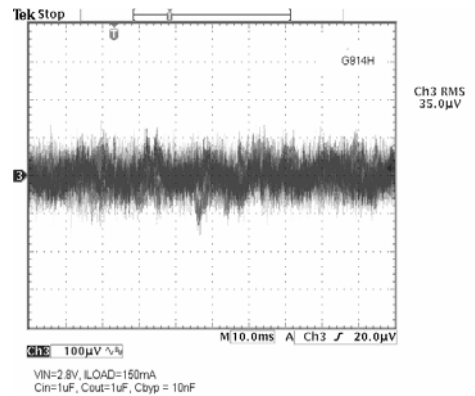

Typical Performance Characteristics (continued)

**Ground Current vs. Temperature**

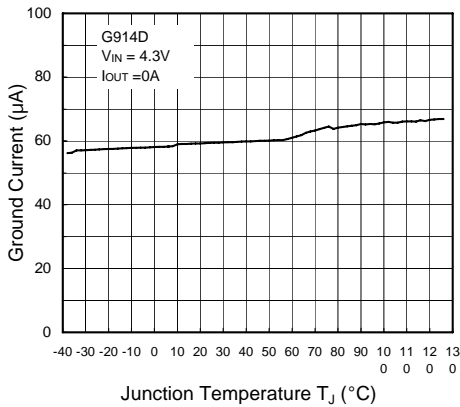

**SHDN Input Bias Current vs. Temperature**

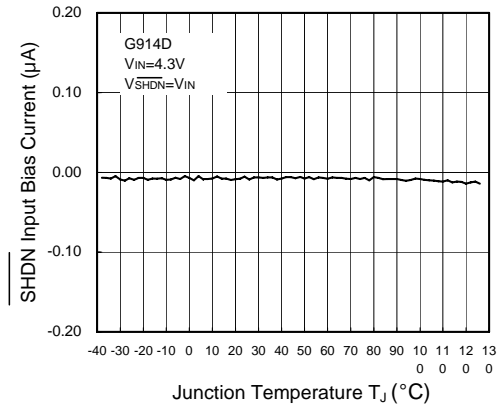

**Shutdown Supply Current vs. Temperature**

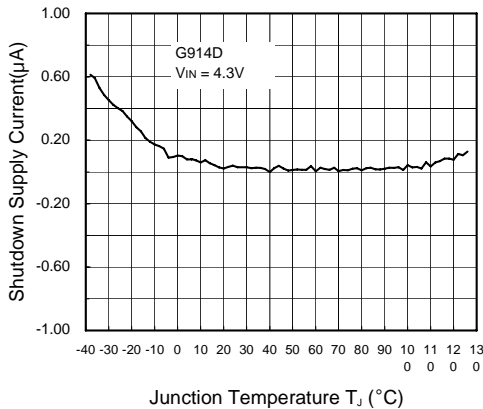

**Output Voltage vs. Temperature**

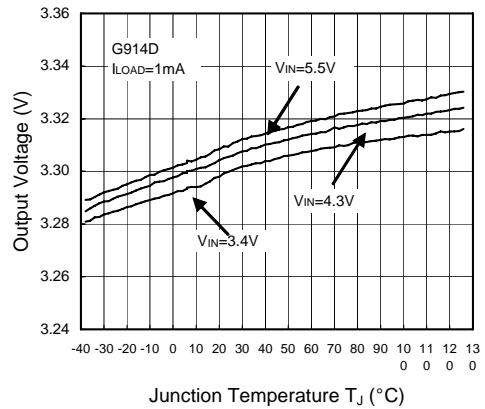

**Dropout Voltage vs. Temperature**

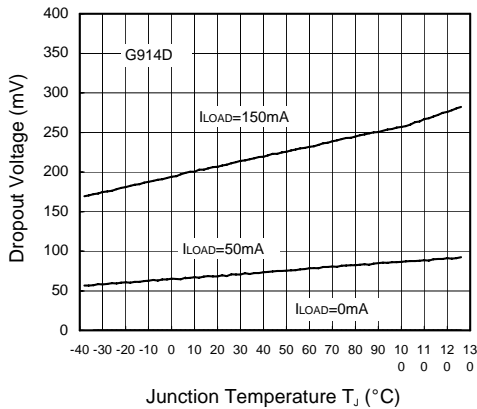

Typical Performance Characteristics (continued)

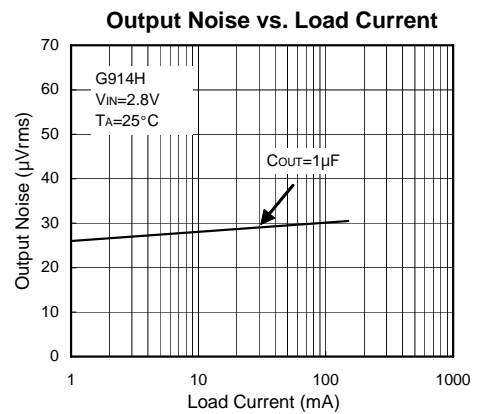
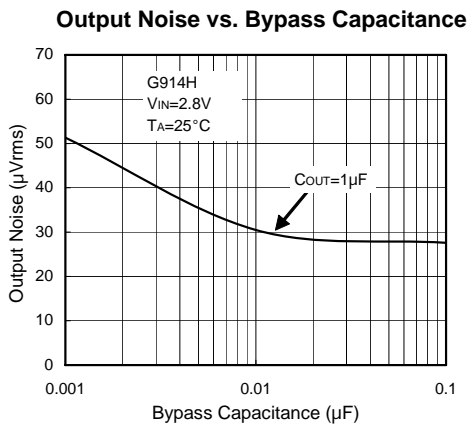
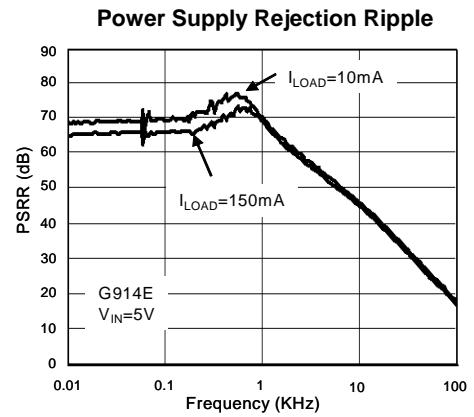
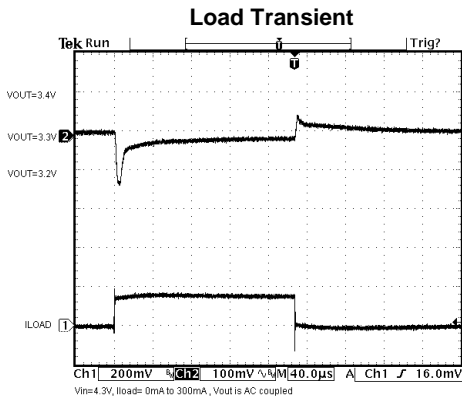
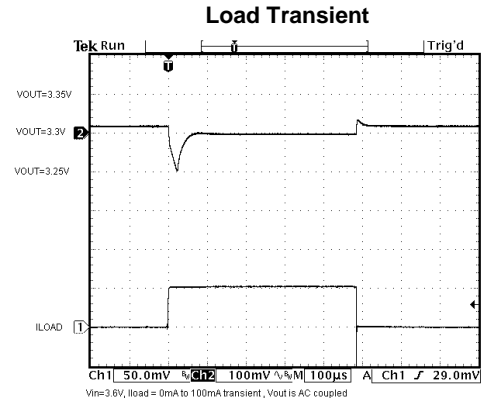
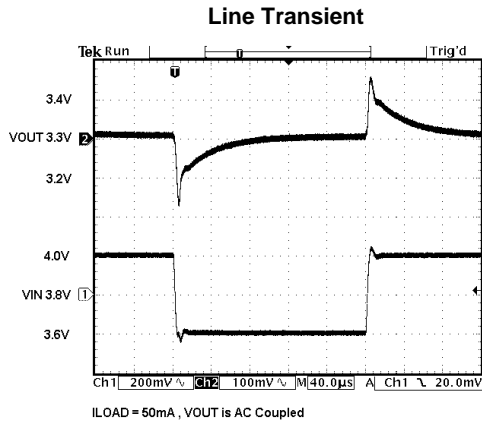

Typical Performance Characteristics (continued)

Power On Response Waveform

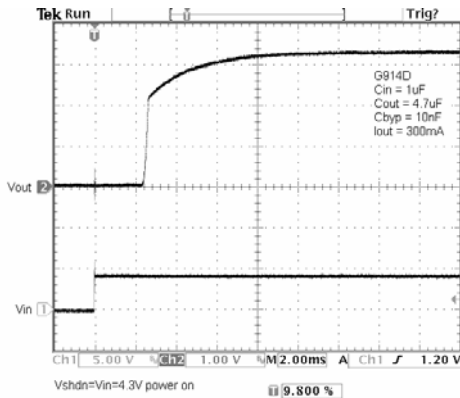

Power Off Response Waveform

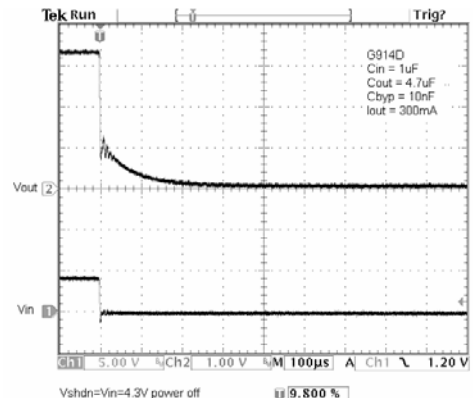

Shutdown Delay Waveform

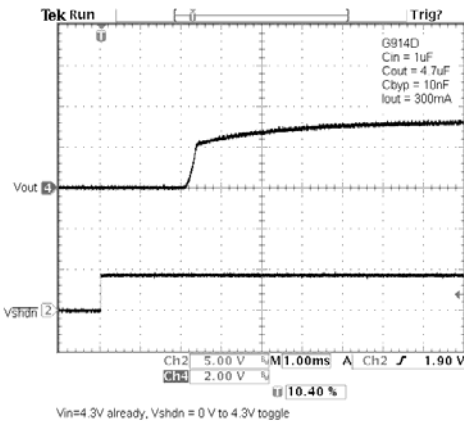

Shutdown Delay Waveform

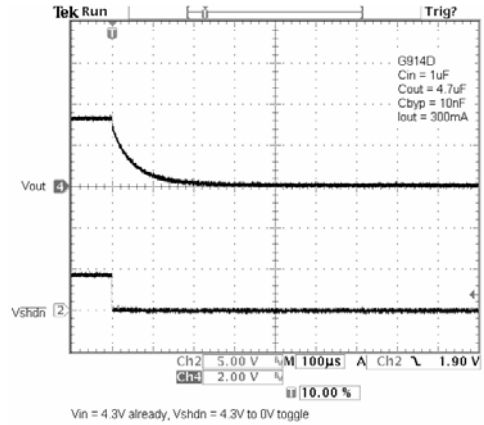

Turn-On Time vs. Bypass Capacitance

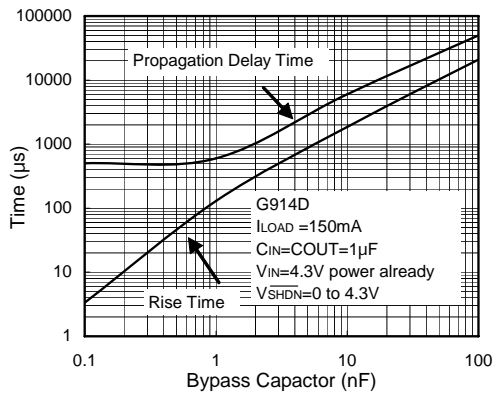

Turn-Off Time vs. Bypass Capacitance

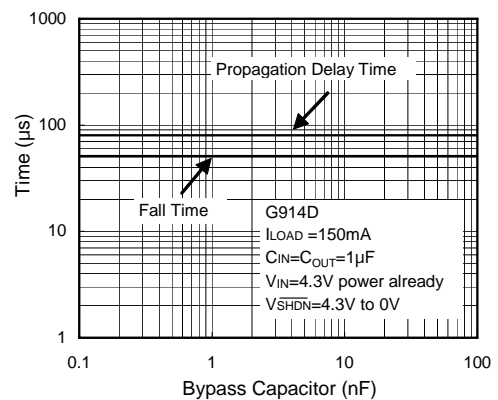

**Pin Description**

PIN		NAME	FUNCTION
G914A~H	G914Z		
1	1	IN	Regulator Input. Supply voltage can range from +2.5V to +6.0V. Bypass with 1μF to GND.
2	2	GND	Ground. This pin also functions as a heatsink. Solder to large pads or the circuit board ground plane to maximize thermal dissipation.
3	3	SHDN	Active-Low Shutdown Input. A logic low reduces the supply current to less than 1μA. Connect to IN for normal operation.
4	---	BYP	This is a reference bypass pin. It should connect external 10nF capacitor to GND to reduce output noise. Bypass capacitor must be no less than 1nF. ( $C_{BYP} \geq 1nF$ )
---	4	SET	Feedback Input for Setting the Output Voltage. Connect to GND to set the output voltage to the preset output voltage. Connect to an external resistor divider for adjustable-output operation. The adjustable output voltage, $V_{OUT}$ , is then given by the following equation: $V_{OUT} = 1.25 (1 + R1/R2)$ , Reference to Typical Application Circuit in Page 1.
5	5	OUT	Regulator Output. Sources up to 300mA. Bypass with a 4.7μF, $<0.2\Omega$ typical ESR capacitor to GND.

**Detailed Description**

The block diagram of the G914X is shown in Figure 1. It consists of an error amplifier, 1.25V bandgap reference, PMOS output transistor, internal feedback voltage divider, shutdown logic, over current protection circuit, and over temperature protection circuit.

The internal feedback voltage divider's central tap is connected to the non-inverting input of the error amplifier. The error amplifier compares non-inverting input with the 1.25V bandgap reference. If the feedback voltage is higher than 1.25V, the error amplifier's output becomes higher so that the PMOS output transistor has a smaller gate-to-source voltage ( $V_{GS}$ ). This reduces the current carrying capability of the PMOS output transistor, as a result the output voltage decreases until the feedback voltage is equal to 1.25V. Similarly, when the feedback voltage is less than

1.25V, the error amplifier causes the output PMOS to conduct more current to pull the feedback voltage up to 1.25V. Thus, through this feedback action, the error amplifier, output PMOS, and the voltage divider effectively form a unity-gain amplifier with the feedback voltage force to be the same as the 1.25V bandgap reference. The output voltage,  $V_{OUT}$ , is then given by the following equation:

$$V_{OUT} = 1.25 (1 + R1/R2). \tag{1}$$

Alternatively, the relationship between R1 and R2 is given by:

$$R1 = R2 (V_{OUT} / 1.25 + 1). \tag{2}$$

For the output voltage versions of G914X, the output voltages are 2.7V for G914A, 2.8V for G914B, 3.0V for G914C, 3.3V for G914D, and 2.5V for G914E, 2.85V for G914F, 1.50V for G914G and 1.80V for G914H.

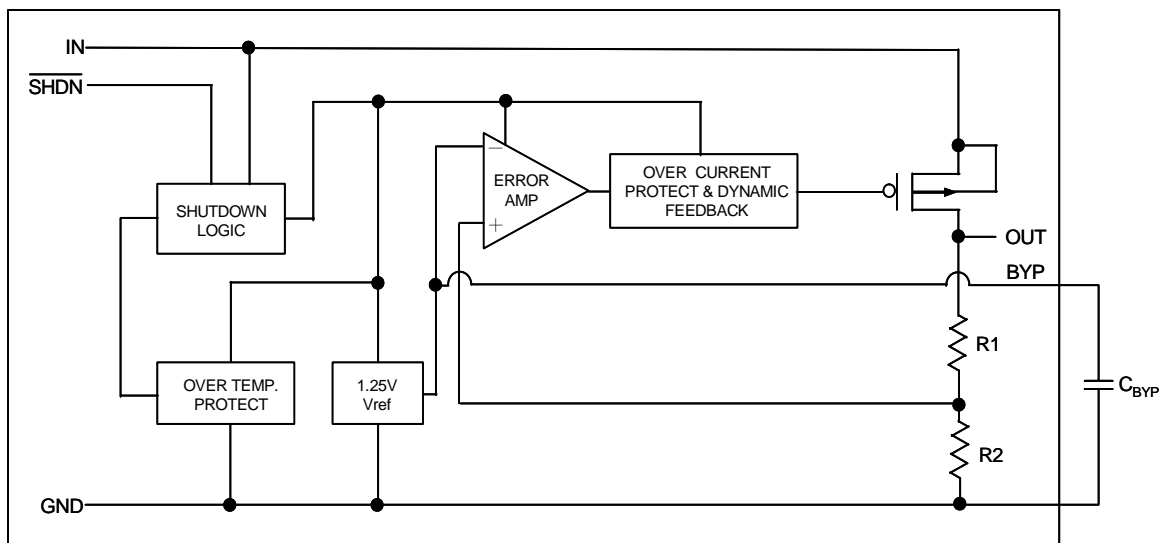

**Figure 1. Functional Diagram**



**Over Current Protection**

The G914X use a current mirror to monitor the output current. A small portion of the PMOS output transistor's current is mirrored onto a resistor such that the voltage across this resistor is proportional to the output current. This voltage is compared against the 1.25V reference. Once the output current exceeds the limit, the PMOS output transistor is turned off. Once the output transistor is turned off, the current monitoring voltage decreases to zero, and the output PMOS is turned on again. If the over current condition persist, the over current protection circuit will be triggered again. Thus, when the output is shorted to ground, the output current will be alternating between 0 and the over current limit. The typical over current limit of the G914X is set to 500mA. Note that the input bypass capacitor of 1 $\mu$ F must be used in this case to filter out the input voltage spike caused by the surge current due to the inductive effect of the package pin and the printed circuit board's routing wire. Otherwise, the actual voltage at the IN pin may exceed the absolute maximum rating.

**Over Temperature Protection**

To prevent abnormal temperature from occurring, the G914X has a built-in temperature monitoring circuit. When it detects the temperature is above 150°C, the output transistor is turned off. When the IC is cooled down to below 135°C, the output is turned on again. In this way, the G914X will be protected against abnormal junction temperature during operation.

**Shutdown Mode**

When the  $\overline{\text{SHDN}}$  pin is connected a logic low voltage, the G914X enters shutdown mode. All the analog circuits are turned off completely, which reduces the current consumption to only the leakage current. The output is disconnected from the input. When the output has no load at all, the output voltage will be discharged to ground through the internal resistor voltage divider.

**Operating Region and Power Dissipation**

Since the G914X is a linear regulator, its power dissipation is always given by  $P = I_{\text{OUT}} (V_{\text{IN}} - V_{\text{OUT}})$ . The maximum power dissipation is given by:

$$P_{\text{DMAX}} = (T_J - T_A) / \theta_{\text{JA}} = (150-25) / 240 = 520\text{mW}$$

Where  $(T_J - T_A)$  is the temperature difference the G914X die and the ambient air,  $\theta_{\text{JA}}$ , is the thermal resistance of the chosen package to the ambient air. For surface mount device, heat sinking is accomplished by using the heat spreading capabilities of the PC board and its copper traces. In the case of a SOT-23-5 package, the thermal resistance is typically 240°C/Watt. (See Recommended Minimum Footprint). Refer to Figure 2 is the G914X valid operating region (Safe Operating Area) & refer to Figure 3 is maximum power dissipation of SOT-23-5.

The die attachment area of the G914X's lead frame is connected to pin 2, which is the GND pin. Therefore, the GND pin of G914X can carry away the heat of the G914X die very effectively. To improve the power dissipation, connect the GND pin to ground using a large ground plane near the GND pin.

**Applications Information****Capacitor Selection and Regulator Stability**

Normally, use a 1 $\mu$ F capacitor on the input and a 4.7 $\mu$ F capacitor on the output of the G914X. Larger input capacitor values and lower ESR provide better supply-noise rejection and transient response. A higher-value input capacitor (10 $\mu$ F) may be necessary if large, fast transients are anticipated and the device is located several inches from the power source. For stable operation over the full temperature range, with load currents up to 120mA, a minimum of 4.7 $\mu$ F is recommended.

**Power-Supply Rejection and Operation from Sources Other than Batteries**

The G914X is designed to deliver low dropout voltages and low quiescent currents in battery powered systems. Power-supply rejection is 70dB at low frequencies as the frequency increases above 20kHz; the output capacitor is the major contributor to the rejection of power-supply noise.

When operating from sources other than batteries, improve supply-noise rejection and transient response by increasing the values of the input and output capacitors, and using passive filtering techniques.

**Load Transient Considerations**

The G914X load-transient response graphs show two components of the output response: a DC shift of the output voltage due to the different load currents, and the transient response. Typical overshoot for step changes in the load current from 0mA to 100mA is 12mV. Increasing the output capacitor's value and decreasing its ESR attenuates transient spikes.

**Input-Output (Dropout) Voltage**

A regulator's minimum input-output voltage differential (or dropout voltage) determines the lowest usable supply voltage. In battery-powered systems, this will determine the useful end-of-life battery voltage. Because the G914X use a P-channel MOSFET pass transistor, their dropout voltage is a function of  $R_{\text{DS(ON)}}$  multiplied by the load current cause the G914X use a P-channel MOSFET pass transistor, their dropout voltage is a function of  $R_{\text{DS(ON)}}$  multiplied by the load current.

**Layout Guide**

An input capacitance of  $\approx 1\mu\text{F}$  is required between the G914X input pin and ground (the amount of the capacitance may be increased without limit), This capacitor must be located a distance of not more than 1cm from the input and return to a clean analog ground.

Input capacitor can filter out the input voltage spike caused by the surge current due to the inductive effect

of the package pin and the printed circuit board's routing wire. Otherwise, the actual voltage at the IN pin may exceed the absolute maximum rating.

The output capacitor also must be located a distance of not more than 1cm from output to a clean analog ground. Because it can filter out the output spike caused by the surge current due to the inductive effect of the package pin and the printed circuit board's routing wire. Figure 4 is G914X PCB recommended layout.

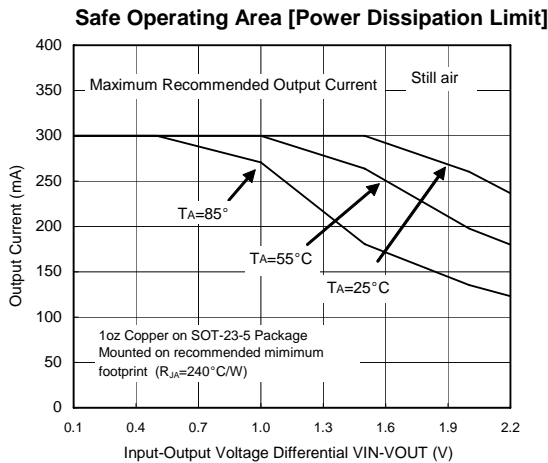

Note:  $V_{IN(max)} \leq 5.5V$

**Figure 2. Safe Operating Area**

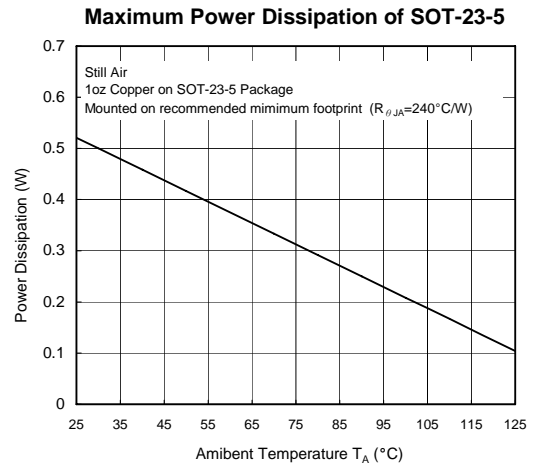

**Figure 3. Power Dissipation vs. Temperature**

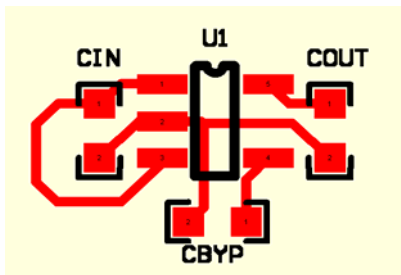

**Figure 4. Fixed Mode**

\*Distance between pin & capacitor must no more than 1cm

**Recommended Minimum Footprint**

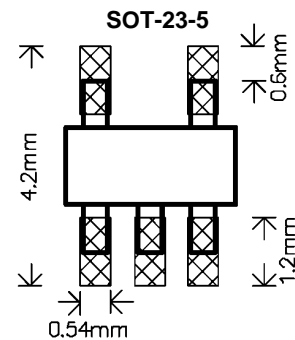

## Package Information

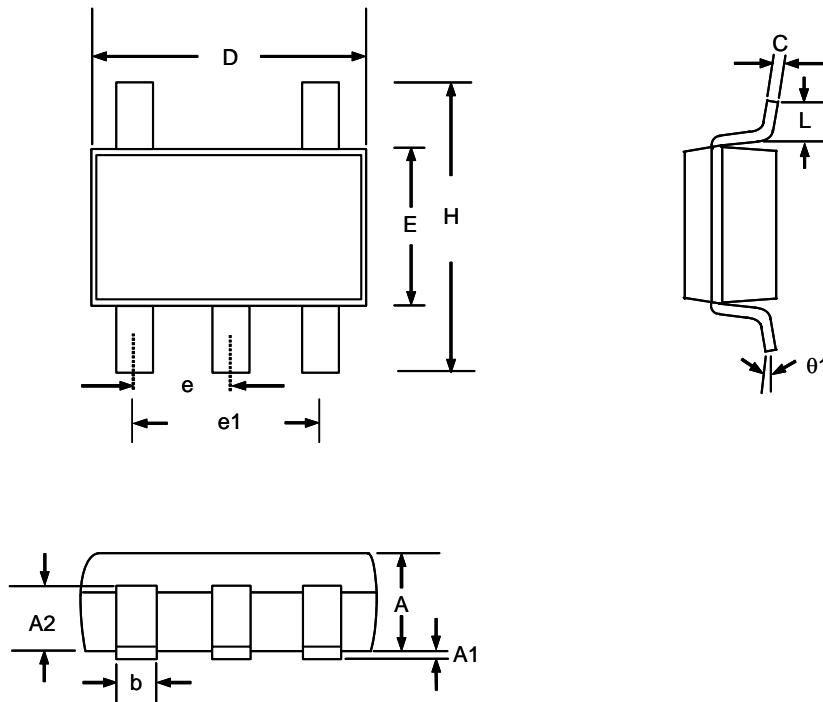

**Note:**

1. Package body sizes exclude mold flash protrusions or gate burrs
2. Tolerance  $\pm 0.1000$  mm (4mil) unless otherwise specified
3. Coplanarity: 0.1000mm
4. Dimension L is measured in gage plane

SYMBOL	DIMENSION IN MM			DIMENSION IN INCH		
	MIN.	NOM.	MAX.	MIN.	NOM.	MAX.
A	1.00	1.10	1.30	0.039	0.043	0.051
A1	0.00	-----	0.10	0.000	-----	0.004
A2	0.70	0.80	0.90	0.028	0.031	0.035
b	0.35	0.40	0.50	0.014	0.016	0.020
C	0.10	0.15	0.25	0.004	0.006	0.010
D	2.70	2.90	3.10	0.106	0.114	0.122
E	1.40	1.60	1.80	0.055	0.063	0.071
e	-----	0.95	-----	-----	0.037	-----
e1	-----	1.90 (TYP)	-----	-----	0.075 (TYP)	-----
H	2.60	2.80	3.00	0.102	0.110	0.118
L	0.37	-----	-----	0.015	-----	-----
$\theta 1$	1°	5°	9°	1°	5°	9°

## Taping Specification

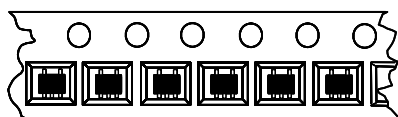

**Feed Direction**  
**SOT-23-5 Package Orientation**

PACKAGE	Q'TY/REEL
SOT-23-5	3,000 ea

GMT Inc. does not assume any responsibility for use of any circuitry described, no circuit patent licenses are implied and GMT Inc. reserves the right at any time without notice to change said circuitry and specifications.