

PLEASE CHECK WWW.MOLEX.COM FOR LATEST PART INFORMATION

Part Number: [0530150210](#)
Status: **Active**
Description: 2.00mm (.079") Pitch MicroBlade™ Wire-to-Board Header, Right Angle, 2 Circuits

Documents:

[3D Model](#) [Product Specification PS-51004-002 \(PDF\)](#)
[Drawing \(PDF\)](#) [RoHS Certificate of Compliance \(PDF\)](#)

Agency Certification

CSA LR19980
 UL E29179

General

Product Family PCB Headers
 Series [53015](#)
 Application Wire-to-Board
 Product Name MicroBlade™

Physical

Breakaway No
 Circuits (Loaded) 2
 Durability (mating cycles max) 30
 First Mate / Last Break No
 Flammability 94V-0
 Glow-Wire Compliant No
 Guide to Mating Part No
 Keying to Mating Part None
 Lock to Mating Part Yes
 Material - Metal Phosphor Bronze
 Material - Plating Mating Tin
 Material - Plating Termination Tin
 Material - Resin Nylon
 Number of Rows 1
 Orientation Right Angle
 PC Tail Length (in) 0.138 In
 PC Tail Length (mm) 3.50 mm
 PCB Locator No
 PCB Retention Yes
 PCB Thickness Recommended (in) 0.062 In
 PCB Thickness Recommended (mm) 1.60 mm
 Packaging Type Bag
 Pitch - Mating Interface (in) 0.079 In
 Pitch - Mating Interface (mm) 2.00 mm
 Polarized to PCB No
 Shrouded Fully
 Stackable No
 Surface Mount Compatible (SMC) No
 Temperature Range - Operating -20°C to +85°C
 Termination Interface: Style Through Hole

Electrical

Current - Maximum per Contact 2A
 Voltage - Maximum 125V

Material Info

Reference - Drawing Numbers

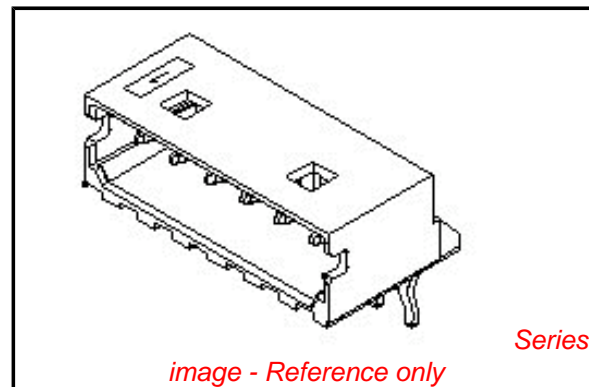

EU RoHS

ELV and RoHS Compliant
REACH SVHC
 Not Reviewed
Halogen-Free Status

China RoHS



Need more information on product environmental compliance?

Email productcompliance@molex.com
 For a multiple part number RoHS Certificate of Compliance, [click here](#)

Please visit the [Contact Us](#) section for any non-product compliance questions.

Search Parts in this Series

[53015Series](#)

Mates With

[51004](#) Crimp Housing. [50011](#) Crimp Terminal

Product Specification

PS-51004-002, RPS-51004-001, RPS-51004-002,
RPS-51004-003, RPS-51004-008, RPS-51004-010,
RPS-51004-011, RPS-51004-014, RPS-51004-015,
RPS-51004-016, RPS-51004-017, RPS-51004-018,
RPS-51004-019, RPS-51004-020, RPS-51004-021,
RPS-51004-022, RPS-51004-023, RPS-51004-024,
RPS-51004-025, RPS-53014-001
SD-53015-**10

Sales Drawing

This document was generated on 04/15/2010

PLEASE CHECK WWW.MOLEX.COM FOR LATEST PART INFORMATION

DWG. NO. SD-53015-***10

DIMENSIONS IN METRIC DO NOT SCALE DRAWING

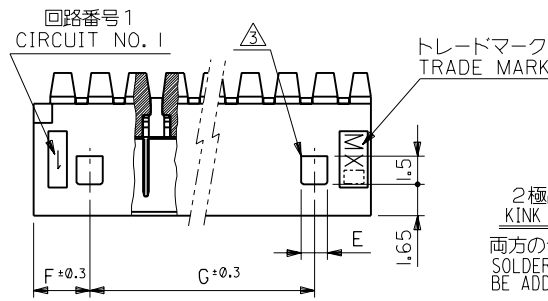

2極品のキンク形態図
KINK FORM FOR 2 CKTS.
両方のテールにキンクを施す。
SOLDER TAIL KINK SHOULD
BE ADDED ON BOTH TAILS.

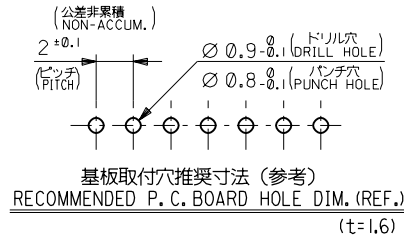
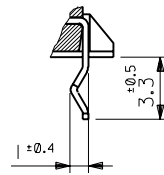

注記 NOTES

1. 嵌合相手 : 510Q4 シリーズ
MATES WITH : 510Q4 SERIES
- △ 3極以上のキンクは、1極おきに2カ所以上に施すこと。
KINK TO BE ADDED ON THE ODD NUMBER
SOLDER TAILS.(FROM THE TRADE MARK SIDE)
- △ ロック穴は、2極と3極は1カ所、4極以上は2カ所とする。
LOCKING HOLE : ONE PLACE FOR 2 AND 3 CKTS.
TWO PLACES FOR 4 AND MORE THAN 4 CKTS.

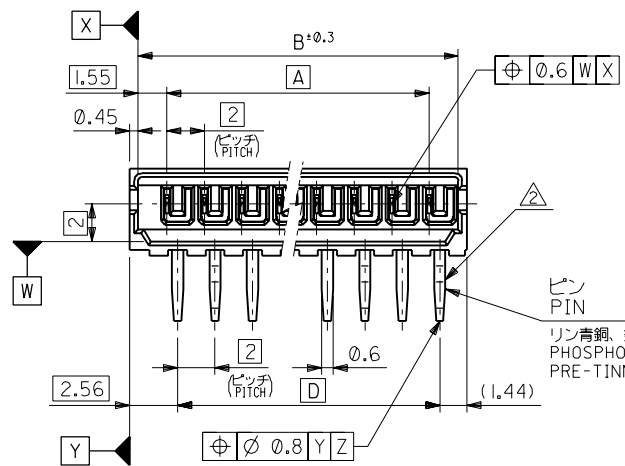

ピン
PIN
リン青銅、錫メッキ (0.9 μm MIN.)
PHOSPHOR BRONZE
PRE-TINNED(0.9 μm MIN.)

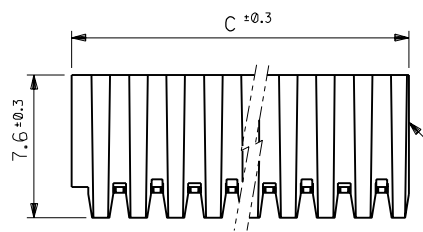
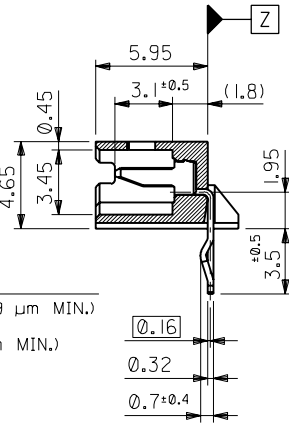

ガラス繊維入りナイロン66 (カラー: オフホワイト)
GLASS FILLED NYLON66 (COLOR: OFF-WHITE)
UL 94V-0

| | | | | | | | | |
|----|---|-----|----|----|------|----|------------|--------------------|
| 26 | 3 | 1.4 | 28 | 32 | 31.1 | 28 | 53015-1510 | 15 |
| 24 | ↑ | ↑ | 26 | 30 | 29.1 | 26 | ↑ -1410 | 14 |
| 22 | | | 24 | 28 | 27.1 | 24 | -1310 | 13 |
| 20 | | | 22 | 26 | 25.1 | 22 | -1210 | 12 |
| 18 | | | 20 | 24 | 23.1 | 20 | -1110 | 11 |
| 16 | | | 18 | 22 | 21.1 | 18 | -1010 | 10 |
| 14 | | | 16 | 20 | 19.1 | 16 | -0910 | 9 |
| 12 | | | 14 | 18 | 17.1 | 14 | -0810 | 8 |
| 10 | | | 12 | 16 | 15.1 | 12 | -0710 | 7 |
| 8 | | | 10 | 14 | 13.1 | 10 | -0610 | 6 |
| 6 | ↓ | ↓ | 8 | 12 | 11.1 | 8 | -0510 | 5 |
| 4 | 3 | 1.4 | 6 | 10 | 9.1 | 6 | -0410 | 4 |
| — | 4 | 3.4 | 4 | 8 | 7.1 | 4 | ↓ -0310 | 3 |
| — | 3 | 1.4 | 2 | 6 | 5.1 | 2 | 53015-0210 | 2 |
| G | F | E | D | C | B | A | ENG. NO. | 極数 NO. OF CKTS. |

| | | | | | |
|----------------------------------|-------|---------------------------------------|-------------|--|--|
| 材料 MATERIAL | | 図中参照 SEE DWG. | | molex MOLEX-JAPAN CO.,LTD. 日本モレックス株式会社 | |
| 仕上げ FINISH | | —H— | | REVISE ONLY ON CAD SYSTEM | |
| 適用電線範囲 WIRE RANGE | | —H— | | TITLE 名称 2.0 LOW PROFILE WAFER ASS'Y R/A | |
| 被覆外径 INS. RANGE | | —H— | | DWG. NO. SD-53015-***10 | |
| DRAWN BY '93/3/31 H.HIRAMOTO | | CHK'D BY '93/3/31 H.HIRAMOTO | | REV E | |
| APP'D BY '93/3/31 M.FUKUSHIMA | | 尺度 SCALE 4 - 1 | | | |
| 角度 ANGLE | ±3° | 再作図及び変更 REDRAWN & REVISED (LS0279) | H.H M.F | '93/3/31 | |
| 30以上 OVER | +0.3 | 変更内容 REVISION RECORD | DR. CHK. | 日付 DATE | |
| 10以上 30未満 OVER | +0.25 | 一般公差 GENERAL TOLERANCES | 記号 LTR | | |
| 10未満 UNDER | +0.2 | | | | |