

Features

Regulated Converters

- UL Certified Constant Current LED Driver
- Wide Input and Output Voltage Range
- Digital PWM and Analogue Voltage Dimming
- Short Circuit and Overtemperature Protected
- Pin, Wire or Open Frame SMD Versions
- IP67 rated for /W Version
- 96% Efficiency

Description

The RCD series is a step-down constant current source designed for driving high power white LEDs. Standard output currents available are 300mA, 350mA, 500mA, 600mA, 700mA, 1A and 1.2A to make this driver compatible with a wide range of LEDs from many different manufacturers without the need for any external components. Despite its compact size, the RCD series is fully featured with very high efficiency, wide input voltage range, high ambient operating temperature and two means of LED dimming: PWM/digital control and analogue voltage dimming. Both dimming controls are independent and can be combined. The driver is also designed to be as reliable as the LEDs it is driving, even at the full operating temperature. Options include an IP67 wired version (W) and an open frame version with SMD pins (/SMD/OF Option).

Selection Guide

Part Number	Input Range (VDC)	Output Current (mA)	Output Voltage (Vmin-Vmax)	Dimming Control	Mounting Style
RCD-24-0.30**	4.5-36V	0-300	2-35	Digital + Analogue	SMD, Pins or Wired
RCD-24-0.35**	4.5-36V	0-350	2-35	Digital + Analogue	SMD, Pins or Wired
RCD-24-0.50**	4.5-36V	0-500	2-35	Digital + Analogue	SMD, Pins or Wired
RCD-24-0.60**	4.5-36V	0-600	2-35	Digital + Analogue	SMD, Pins or Wired
RCD-24-0.70**	4.5-36V	0-700	2-35	Digital + Analogue	SMD, Pins or Wired
RCD-24-1.00**	6-36V	0-1000	3-33	Digital + Analogue	Pins or Wired
RCD-24-1.20**	6-36V	0-1200	3-33	Digital + Analogue	Pins or Wired

** No suffix is standard with PCB Pins.

** Add suffix /SMD/OF for open frame version with SMD solderpins

** Add suffix /SMD/OF-R for open frame version with SMD solderpins packed in Tape and Reel (SMD versions available in 300mA ~ 700mA only)

** Add suffix /W for standard wired version without dimming control (four wires)

** Add suffix /W/X1 for wired version with analogue dimming control (five wires)

** Add suffix /W/X2 for wired version with PWM dimming control (five wires)

** Add suffix /W/X3 for wired version with both analogue and PWM dimming controls (six wires)

Specifications

(typical at 25°C, nominal input voltage, rated output current unless otherwise specified)

Input Voltage (absolute maximum)	40VDC max	
Recommended Input Voltage	300mA-700mA 1A-1.2A	5V min. / 24V typ. / 36VDC max 6V min. / 24V typ. / 36VDC max
Input Filter	Capacitor	
Output Current Accuracy (Vin = 24DC)	300mA-700mA 1A-1.2A	±1% typ, ±3% max. ±2% typ, ±5% max.
Internal Power Dissipation	Worst case load of 5 LEDs	800mW max
Output Current Stability	Vin=36V, Vout =1-9 LEDs	±1% max
Output Ripple and Noise (20MHz BW)	300mA-700mA	120mVp-p max
Vin=36V, Vout =1-9 LEDs	1A-1.2A	200mVp-p max
Temperature Coefficient	-40°C~+85°C ambient	±0.015%/°C max
Maximum Capacitive Load	100µF	
Operating Frequency	300mA-700mA 1A-1.2A	210kHz min/ 260kHz typ/ 300kHz max 350kHz min/ 450kHz typ/ 550kHz max
Efficiency at Full Load	96% max.	
Short Circuit Protection	Regulated at rated output current	

continued on next page

INNOLINE DC/DC-Converter

RECOM

Constant Current LED Driver

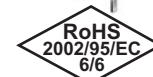

E224736

EN-60950-1 Certified
UL-60950-1 Certified

RCD-24

Derating Graph

(Ambient Temperature)

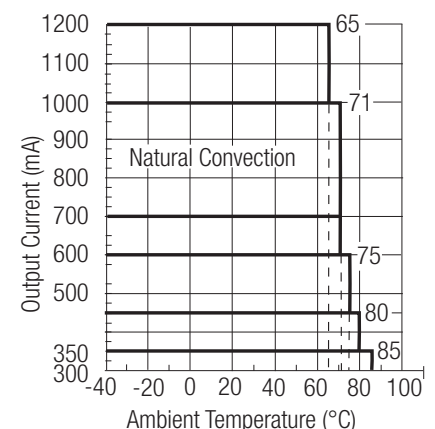

Refer to Application Notes

Specifications -Continued

Operating Temperature Range (free air convection)	300mA-350mA	-40°C to +85°C
	500mA	-40°C to +80°C
	600mA	-40°C to +75°C
	700mA-1A	-40°C to +71°C
	1.2A	-40°C to +65°C
Storage Temperature Range		-55°C to +125°C
Overtemperature Shutdown (Auto-restart after cool down)	Internal IC Temperature	150°C typ.
	Temperature Hysteresis	20°C typ.
Maximum Case Temperature		100°C
Thermal Impedance	Natural Convection	55°C/Watt
Case Material (Pinned or Wired Versions)		Non Conductive Black Plastic
Potting Material (Pinned or Wired Versions)		Epoxy (UL94-V0)
Dimensions	Pinned or Wired Versions	22.1 x 12.6 x 8.5mm
	SMD	21.0 x 11.4 x 10mm
Weight	Pinned or Wired Versions	4.5g
	SMD	1.9g
Soldering Profile	Pinned or Wired Versions	265°C/10 sec. max
	SMD	245°C/30 sec. max
Packing Quantities	Pinned Versions	39pcs per Tube
	SMD Versions	32pcs per Tube
		400pcs per Reel
(Refer to App Notes for Tube sizes)	Wired Versions	5pcs per Bag

PWM Dimming and ON/OFF Control (Leave open if not used)

Remote ON/OFF	DC/DC ON	300mA-700mA	Open or $0V < V_r < 0.6V$
Threshold Voltages		1A-1.2A	Open or $0V < V_r < 0.8V$
	DC/DC OFF (Standby)	300mA-700mA	$0.6 < V_r < 2.9V$
		1A-1.2A	$1.4 < V_r < 2.2V$
Remote Pin Drive Current	DC/DC OFF (Shutdown)	300mA-700mA	$2.9V < V_r < 6V$
		1A-1.2A	$2.2V < V_r < 15V$
		$V_r = 5V$	1mA max
Quiescent Input Current in Shutdown Mode	$V_{in} = 36V$		200µA max
Maximum PWM Frequency (measured 10%~90% Dimming)	For Linear Operation		20 -200Hz
	Maximum Frequency		2000Hz

Analogue Dimming Control (leave open if not used)

Input Voltage Range		-0.3V - 15V
Control Voltage Range Limits (see Graph)	Full On	$0.13V \pm 50mV$
	Full Off	$4.5V \pm 50mV$
Analogue Pin Drive Current	$V_c = 5V$	0.2mA max.

Environmental

Relative Humidity		5% to 95% RH, non-condensing	
/W Versions		IP67	
Conducted Emissions	(all series, see note)	EN55022	Class B
Radiated Emissions	(all series except 700mA)	EN55022	Class B
ESD	(all series)	EN61000-4-2	Class A
Radiated Immunity	(all series)	EN61000-4-3	Class A
Fast Transient	(all series)	EN61000-4-4	Class A
Conducted Immunity	(all series)	EN61000-4-6	Class A
MTBF (RCD-24-0.70, Nominal V_{in} , Full Load) using MIL-HDBK 217F	+25°C		605×10^3 hours
	+71°C		516×10^3 hours

Note: Requires an input filter to meet EN55022 ClassB conducted emissions - see next page

Digital Dimming

PWM Digital Control Signal

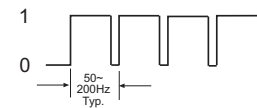

Output Current (LED appears dim)



PWM Digital Control Signal

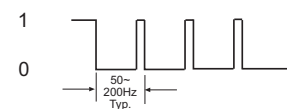

Output Current (LED appears bright)



Analogue Dimming

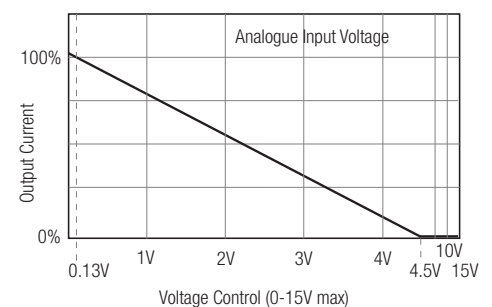

Combined PWM and Analogue Dimming

PWM Digital Control Signal



Output Current

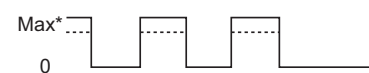

* Max output current can also be set using Analogue input

Typical Characteristics

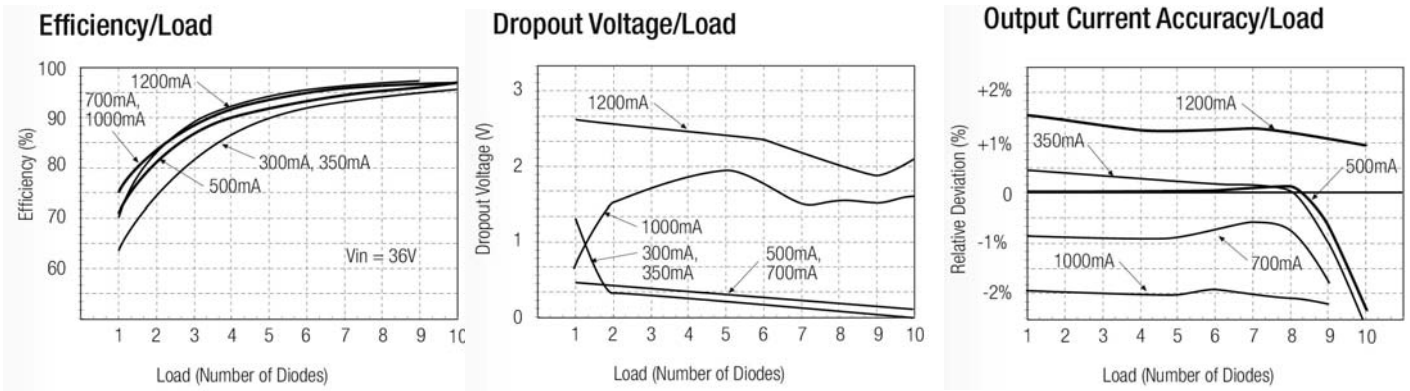

Class B Filter Suggestion

RCD-24-0.30 - RCD-24-0.70

No dimming or PWM dimming only:

- $L1 = 47\mu H$
- $C2 = C3 = 10nF$ MLCC
- Other caps not required

Analogue Dimming used:

- $L1 = 120\mu H$
- $C2 = C7 = 10nF$ MLCC
- Other caps not required

RCD-24-1.00 - RCD-24-1.20

- $L1 = 220\mu H$
- $C2 = 10nF$ MLCC
- $C3 = C5 = 2.2nF$ MLCC
- $C4 = C6 = C7 = C8 = 100nF$ MLCC

$C2^*$ = optional $2\mu 2$ MLCC required only if $L1$ starts to resonate with the back ripple current.

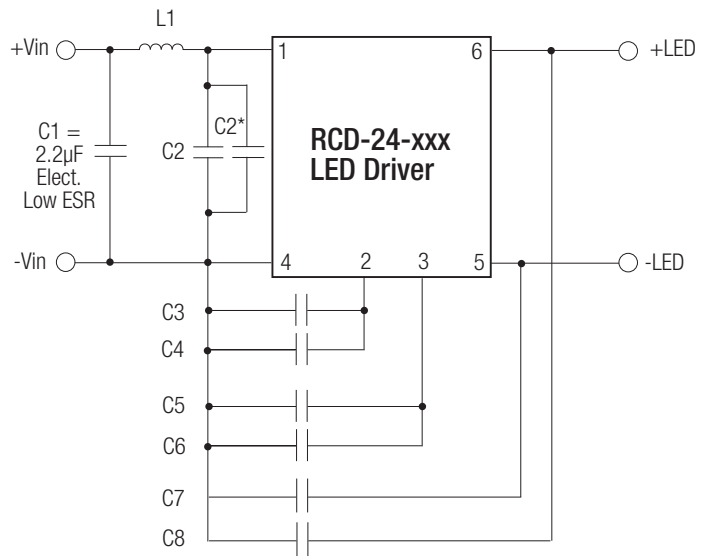

RCD-24

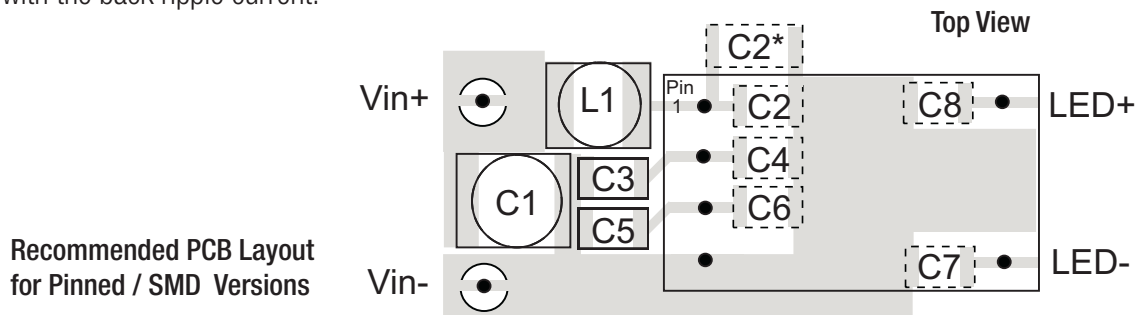

Application Examples

Standard Application

LED DRIVER with 0-10V Interface

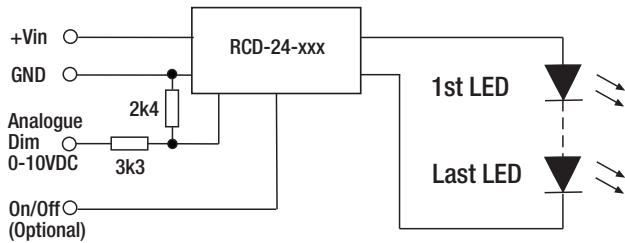

LED DIMMER for up to 7 white LEDs

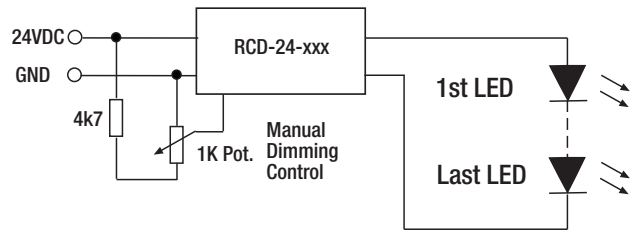

MULTIPLE LED DRIVER (up to 20 LEDs)

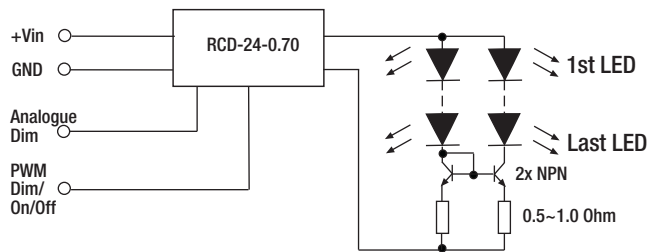

LED DIMMER with high frequency PWM control

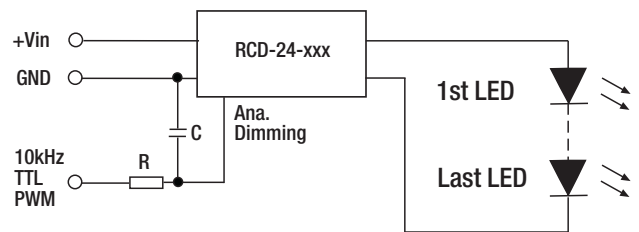

Driving Two Strings of 350mA LEDs with one 700mA Driver using a current mirror

LED Temperature Monitoring

RGB Driver

SIMPLE RGB Mixer

Automatic LED Overtemperature Protection

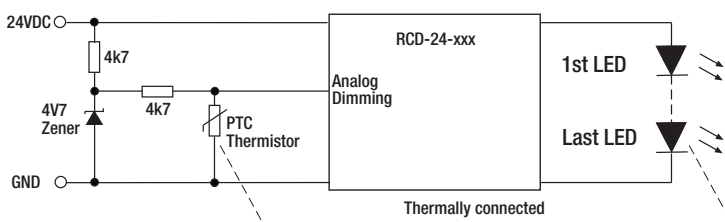

Typical Response Curve (PTC = 500 Ohm @ 70°C)

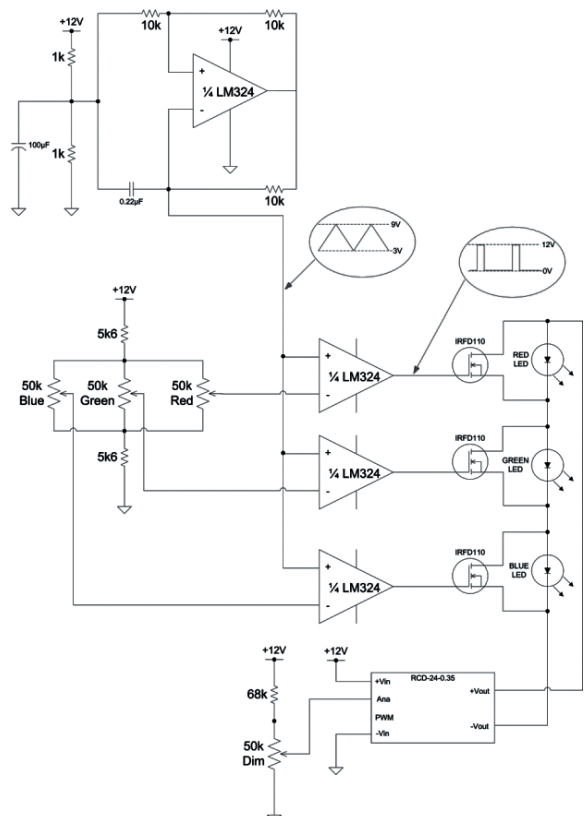
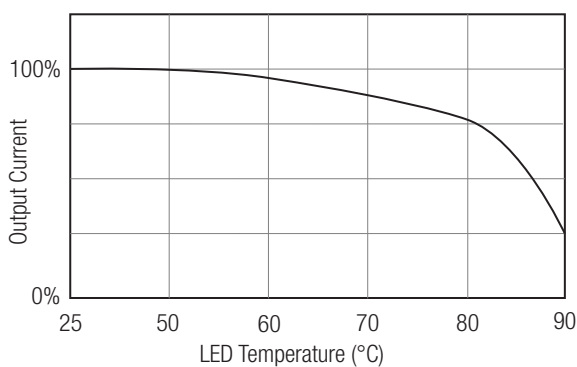

Package Style and Pinning

Pinned Version

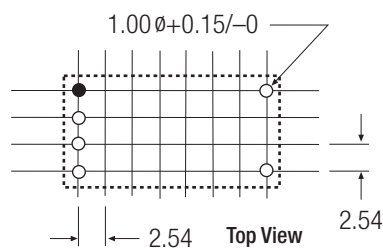
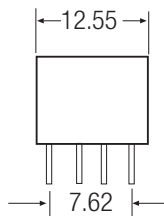
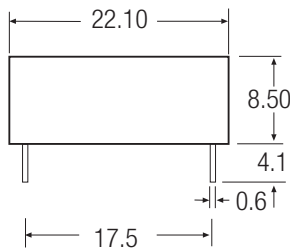

Recommended Footprint Details

Pin #	Out	Comments
1	+Vin	DC Supply
2	Analogue Dimming	Leave open if not used
3	PWM/ON/OFF	Leave open if not used
4	GND	Do not connect to -Vout
5	-Vout	LED Cathode Connection
6	+Vout	LED Anode Connection

XX.X ± 0.5 mm
XX.XX ± 0.25 mm
Pin Tolerance ± 0.1 mm

Leave 1 mm space around case on PCB

SMD Version

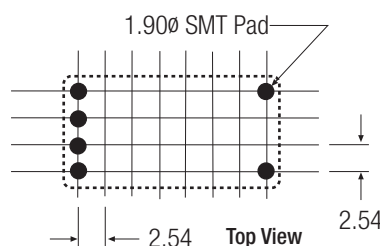
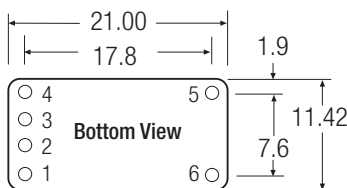
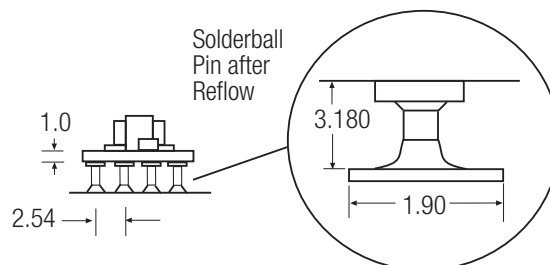
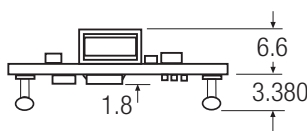

Pin #	Out	Comments
1	+Vin	DC Supply
2	Analogue Dimming	Leave open if not used
3	PWM/ON/OFF	Leave open if not used
4	GND	Do not connect to -Vout
5	-Vout	LED Cathode Connection
6	+Vout	LED Anode Connection

XX.X ± 0.5 mm
XX.XX ± 0.25 mm
XX.XXX ± 0.01 mm

RCD-24

Due to the compact size of the Open Frame version, a product code label is used instead of the whole part number.

The product code consists of RCD xxxx (where xxxx is the datecode) followed by an 8 digit reference code, e.g.

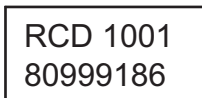

= RCD-24-0.35/SMD/OF, manufactured in Week 1 of 2010.

The reference codes for standard parts are:

- RCD-24-0.30/SMD/OF = 80999199
- RCD-24-0.35/SMD/OF = 80999186
- RCD-24-0.50/SMD/OF = 80999200
- RCD-24-0.60/SMD/OF = 80999201
- RCD-24-0.70/SMD/OF = 80999202

Other custom or semi-custom parts may have different reference codes.

Package Style and Pinning

Wired Versions

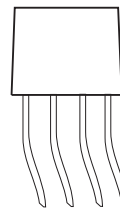
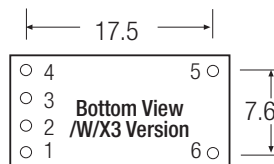
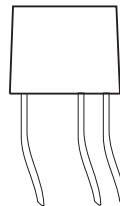
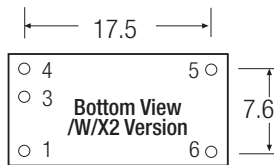
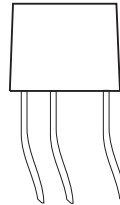
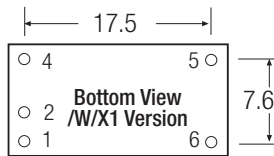
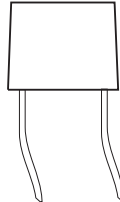
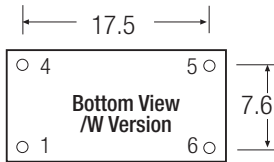

Wire Connections RCD-24/W Series

Wire #	Function	Comments
1 (Red)	+Vin	DC Supply
4 (Black)	GND	Do not connect to -Vout
5 (Brown)	-Vout	LED Cathode Connection
6 (Yellow)	+Vout	LED Anode Connection

Wire length = 100mm + 10mm stripped & tinned = 110mm total
 Wire outside diameter = 1.6mm
 Wire core diameter = 0.75mm
 Wire is UL/CSA listed/ 22AWG / 300V Rated

Wire Connections RCD-24/W/X Series

Wire #	Function	Comments
2 (Green)	Ana Dimming	/X1
3 (Blue)	PWM Dimming	/X2
2 + 3 (Green + Blue)	Ana + PWM Dimming	/X3

Wire length = 100mm + 10mm stripped & tinned = 110mm total
 Wire outside diameter = 1.6mm
 Wire core diameter = 0.75mm
 Wire is UL/CSA listed/ 22AWG / 300V Rated

Wired Versions are packed in bags - 5pcs per bag.