

**PLEASE CHECK WWW.MOLEX.COM FOR LATEST PART INFORMATION**

**Part Number:** [0022012025](#)  
**Status:** **Active**  
**Overview:** [kk](#)  
**Description:** 2.54mm (.100") Pitch KK® Crimp Terminal Housing, Friction Ramp, 2 Circuits, Use with 4809

**Documents:**

<a href="#">3D Model</a>	<a href="#">Product Specification PS-99020-0088 (PDF)</a>
<a href="#">Drawing (PDF)</a>	<a href="#">RoHS Certificate of Compliance (PDF)</a>
<a href="#">Product Specification PS-10-07 (PDF)</a>	

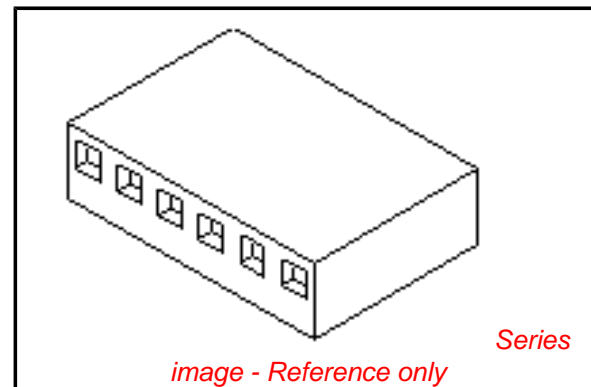

**Agency Certification**

CSA	LR19880
UL	E29179

**General**

Product Family	Crimp Housings
Series	<a href="#">6471</a>
Overview	<a href="#">kk</a>
Product Name	KK®

**Physical**

Circuits (maximum)	2
Color - Resin	Natural (White)
Flammability	94V-0
Gender	Female
Glow-Wire Compliant	No
Lock to Mating Part	Yes
Material - Resin	Nylon
Number of Rows	1
Packaging Type	Bag
Panel Mount	No
Pitch - Mating Interface (in)	0.100 In
Pitch - Mating Interface (mm)	2.54 mm
Polarized to Mating Part	Yes
Stackable	No
Temperature Range - Operating	0°C to +75°C

**Material Info**

Old Part Number	6471-02(I)
-----------------	------------

**Reference - Drawing Numbers**

Product Specification	PS-10-07, PS-99020-0088
Sales Drawing	SD-6471-N*-**, SDE-6471-N*-*, SDE-6471-N*D-A

**EU RoHS**

**ELV and RoHS Compliant**  
**REACH SVHC**  
 Not Reviewed  
**Halogen-Free Status**

**China RoHS**



**Need more information on product environmental compliance?**

Email [productcompliance@molex.com](mailto:productcompliance@molex.com)  
 For a multiple part number RoHS Certificate of Compliance, [click here](#)

Please visit the [Contact Us](#) section for any non-product compliance questions.

**Search Parts in this Series**

[6471Series](#)

**Mates With**

2.54mm (.100") Pitch KK ® PCB Headers

**Use With**

[4809](#) KK® Crimp Terminal

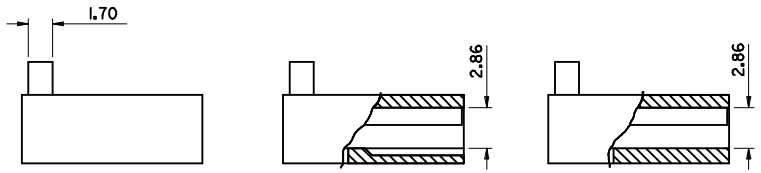
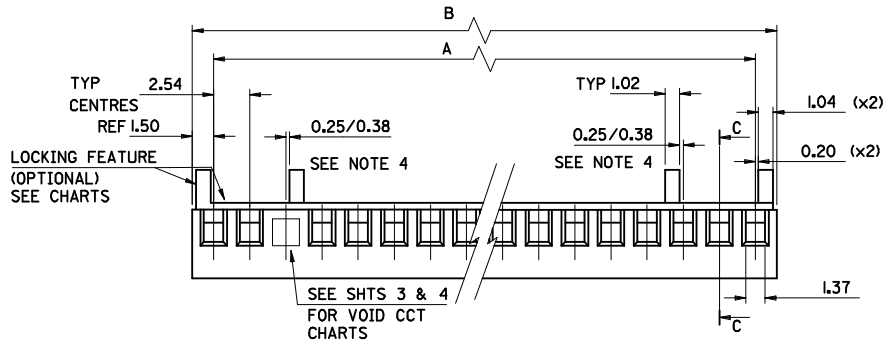

C-C  
PARTIAL SECTION

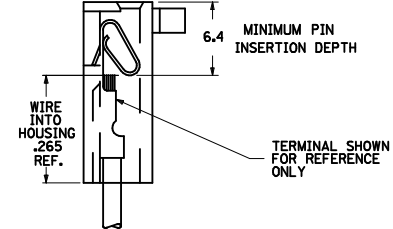
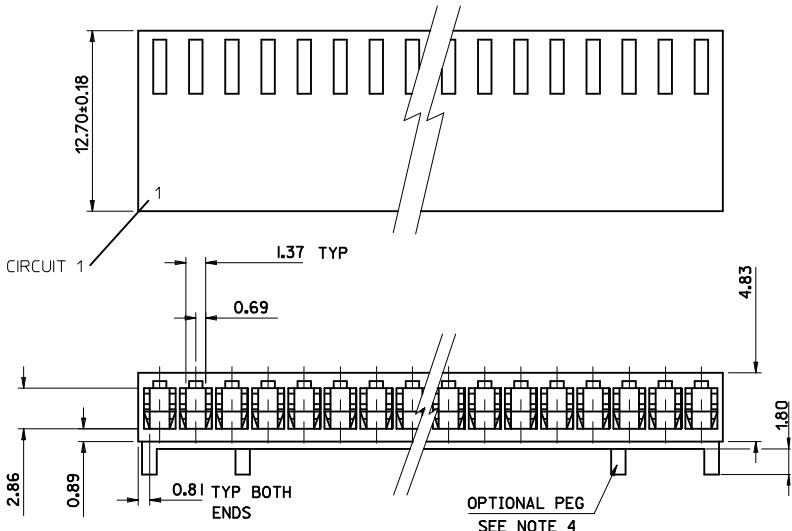

- NOTES:
1. MATERIAL: POLYAMIDE (PA66/6), UL94 V-0  
COLOR: NATURAL PER THE FOLLOWING 89992-0086
  2. FOR USE WITH ANTI-FISH HOOKING TERMINAL No. 4809-\*
  3. SEE SHT. 3 FOR PARTS WITH VOIDS.
  4. OPTIONAL CENTRE PEGS TO BE USED ON Tcct & LARGER SIZES ONLY. SEE SHT. 3 FOR CHARTED ENG. No.'S.
  5. PART No. PRECEDED BY CODE LETTER DESIGNATES MFG. LOC'N. I=IRELAND

HOUSING STYLE

- BLANK NO LOCKING RAMP
- I = LOCKING RAMP & POL. RIB
- S = OPT. PEG
- R = LOCKING RAMP ONLY

E-6471-N-\*\*\*

No. OF CCTS

- BLANK = STD. VOID
- B = OPT. STYLE VOID
- VOID CCT LOC'N.

6. 'MX\*' MARK AND PART I.D. '6471' APPEAR EITHER ON FRONT OR BACK SIDE. SEE FRONT VIEW FOR SIDE ORIENTATION.

28	68.58±0.35	71.58±0.35
27	66.04±0.35	69.04±0.35
26	63.50±0.35	66.50±0.35
25	60.96±0.35	63.96±0.35
24	58.42±0.35	61.42±0.35
23	55.88±0.35	58.88±0.35
22	53.34±0.35	56.34±0.35
21	50.80±0.35	53.80±0.35
20	48.26±0.35	51.26±0.35
19	45.72±0.35	48.72±0.35
18	43.18±0.35	43.18±0.35
17	40.64±0.35	43.64±0.35
16	38.10±0.35	41.10±0.35
15	35.56±0.35	38.56±0.35
14	33.02±0.35	33.02±0.35
13	30.48±0.35	33.48±0.35
12	27.94±0.35	30.94±0.35
11	25.40±0.35	28.40±0.35
10	22.86±0.35	25.86±0.35
9	20.32±0.35	23.32±0.35
8	17.78±0.35	20.78±0.35
7	15.24±0.35	18.24±0.35
6	12.70±0.15	15.70±0.15
5	10.16±0.15	13.16±0.15
4	7.62±0.15	10.62±0.15
3	5.08±0.15	8.08±0.15
2	2.54±0.15	5.54±0.15
No. OF CCTS	DIM A	DIM B

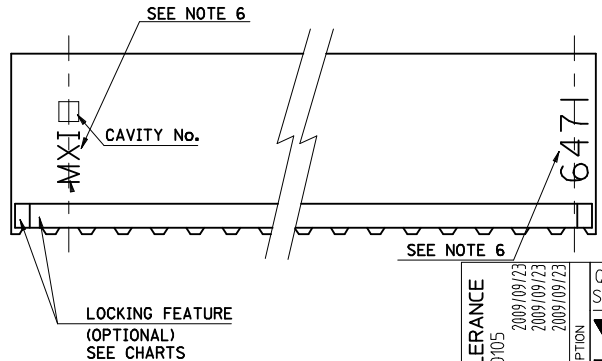

ADJUST TOLERANCE

EC NO: E2010-0105

DRWN: BMAGUIRE 2009/09/23

CHKD: 2009/09/23

APPR: BMAGUIRE 2009/09/23

DESCRIPTION

REV

QUALITY SYMBOLS

GENERAL TOLERANCES (UNLESS SPECIFIED)

	mm	INCH
4 PLACES	±---	±---
3 PLACES	±---	±---
2 PLACES	±0.15	±---
1 PLACE	±0.25	±---
ANGULAR ±---°		

DRAFT WHERE APPLICABLE MUST REMAIN WITHIN DIMENSIONS

DIMENSION STYLE

MM ONLY

SCALE 1:1

DESIGN UNITS METRIC

THIRD ANGLE PROJECTION

DRAWN BY SF DATE 2000/07/14

CHECKED BY DWASZKIEWICZ DATE 2006/02/27

APPROVED BY JDENNEHY DATE 2006/02/27

MATERIAL NO. SEE CHART

SIZE A2

TITLE

2.54 MM KK CRP TRM HSG IL

MATERIAL NO. SD-6471-N\*\*\*

DOCUMENT NO. SD-6471-N\*\*\*

SHEET NO. 1 OF 5

THIS DRAWING CONTAINS INFORMATION THAT IS PROPRIETARY TO MOLEX INCORPORATED AND SHOULD NOT BE USED WITHOUT WRITTEN PERMISSION

PART NO. SEE CHART  
 DWG. NO. SD-6471-N-...

PART No.	ENG No.	No. OF CIRCUITS	RAMP & POL. RIBS	DIM. A	DIM. B
22-01-2025	E-6471-021	2	YES	↑	↑
↑ -2035	↑ -031	3	↑		
-2045	-041	4			
-2055	-051	5			
-2065	-061	6			
-2075	-071	7			
-2085	-081	8			
-2095	-091	9			
-2105	-101	10			
-2115	-111	11			
-2125	-121	12			
-2135	-131	13			
-2145	-141	14			
-2155	-151	15			
-2165	-161	16			
-2175	-171	17			
-2185	-181	18			
-2195	-191	19			
-2205	-201	20			
-2215	-211	21			
-2225	-221	22			
↓ -2235	-231	23			
22-01-2245	-241	24			
NOT TOOLED	-251	25			
22-01-2265	-261	26			
NOT TOOLED	↓ -271	27			
22-01-2285	E-6471-281	28	YES	↓	↓

SEE SHEET I FOR DIMENSION  
 SEE SHEET I FOR DIMENSION

PART No.	ENG No.	No. OF CIRCUITS	LOCKING FEATURE	DIM. A	DIM. B
22-01-2026	E-6471-2	2	NO	↑	↑
↑ -2036	↑ -3	3	↑		
-2046	-4	4			
-2056	-5	5			
-2066	-6	6			
-2076	-7	7			
-2086	-8	8			
-2096	-9	9			
-2106	-10	10			
-2116	-11	11			
-2126	-12	12			
-2136	-13	13			
-2146	-14	14			
-2156	-15	15			
-2166	-16	16			
-2176	-17	17			
-2186	-18	18			
-2196	-19	19			
-2206	-20	20			
↓ -2216	-21	21			
22-01-2226	-22	22			
NOT TOOLED	-23	23			
22-01-2246	-24	24			
NOT TOOLED	-25	25			
22-01-2266	-26	26			
22-01-2276	↓ -27	27			
22-01-2286	E-6471-28	28	NO	↓	↓

SEE SHEET I FOR DIMENSION  
 SEE SHEET I FOR DIMENSION

A SEE SHEET I.

**REVISIONS**

DIMENSIONS SHOWN ( METRIC ) INCH  
 UNLESS OTHERWISE SPECIFIED  
 TOLERANCES: ANGULAR ± 1/2°

3 PLACE ± .	
2 PLACE ± .	±
1 PLACE ± .	±

DRAFT WHERE APPLICABLE MUST REMAIN WITHIN DIMENSIONS

DESIGN DIMENSION  (MM)  IN.  
 (PRIMARY)

EQUIVALENT DIMENSION  (MM)  IN.  
 (SECONDARY)

DRWG BY: SF  
 CHK'D BY:  
 APP'D BY:  
 SCALE: -

**REVISE ONLY ON CAD SYSTEM** SHL REV.

CAD/CAM FILENAME: SD-6471-N-.502  
 THIS DRAWING CONTAINS INFORMATION THAT IS PROPRIETARY TO MOLEX INC. & SHOULD NOT BE USED WITHOUT WRITTEN PERMISSION

TITLE: 2.54 mm KK Crp Trm Hsg II

**MOLEX EUROPE** SHEET NO. DATE: 20F 15/07/00

PART NO. SEE CHART DWG NO. SD-6471-N-... SIZE B

PART NO. SEE CHART  
 DWG. NO. SD-6471-N-...

PART No.	ENG No.	No. OF CIRCUITS	RAMP & POL. RIBS	VOID CCT LOCATION	DIM. A	DIM. B
22-01-4022	E-6471-021-02	2	YES	2	↑	↑
↑ -4032	↑ -031-02	3	↑	↑	↑	↑
-4042	-041-02	4				
-4052	-051-02	5				
-4062	-061-02	6				
-4072	-071-02	7				
-4082	-081-02	8				
-4092	-091-02	9				
-4102	-101-02	10				
-4112	-111-02	11				
-4122	-121-02	12				
-4132	-131-02	13				
-4142	-141-02	14				
-4152	-151-02	15				
-4162	-161-02	16				
-4172	-171-02	17				
-4182	-181-02	18				
-4192	-191-02	19				
-4202	-201-02	20				
-4212	-211-02	21				
-4222	-221-02	22				
-4232	-231-02	23				
-4242	-241-02	24				
-4252	-251-02	25				
-4262	-261-02	26				
-4272	-271-02	27				
22-01-4282	E-6471-281-02	28	YES	2	↓	↓

PART No.	ENG No.	No. OF CIRCUITS	LOCKING FEATURE	VOID CCT LOCATION	DIM. A	DIM. B
22-01-4021	E-6471-02-02	2	NO	2	↑	↑
↑ -4031	↑ -03-02	3	↑	↑	↑	↑
-4041	-04-02	4				
-4051	-05-02	5				
-4061	-06-02	6				
-4071	-07-02	7				
-4081	-08-02	8				
-4091	-09-02	9				
-4101	-10-02	10				
-4111	-11-02	11				
-4121	-12-02	12				
-4131	-13-02	13				
-4141	-14-02	14				
-4151	-15-02	15				
-4161	-16-02	16				
-4171	-17-02	17				
-4181	-18-02	18				
-4191	-19-02	19				
-4201	-20-02	20				
-4211	-21-02	21				
-4221	-22-02	22				
-4231	-23-02	23				
-4241	-24-02	24				
-4251	-25-02	25				
-4261	-26-02	26				
↓ -4271	↓ -27-02	27				
22-01-4281	E-6471-28-02	28	NO	2	↓	↓

SEE SHEET I.		DIMENSIONS SHOWN ( METRIC ) INCH UNLESS OTHERWISE SPECIFIED TOLERANCES: ANGULAR ± 1/2°		DRWG BY <b>SF</b>		REVISE ONLY ON CAD SYSTEM		SHL REV.	
		INCH ( METRIC )		CHK'D BY		CAD/CAM FILENAME SD-6471-N - .503		THIS DRAWING CONTAINS INFORMATION THAT IS PROPRIETARY TO MOLEX INC. & SHOULD NOT BE USED WITHOUT WRITTEN PERMISSION	
A		3 PLACE ± .		APP'D BY		TITLE <b>2.54 mm KK Crp Trm Hsg II</b>		SHEET NO. DATE	
		2 PLACE ± .		SCALE		MOLLEX MOLEX EUROPE		30F 13/07/00	
LTR		1 PLACE ±		SCALE		PART NO.		SIZE	
		DRAFT WHERE APPLICABLE MUST REMAIN WITHIN DIMENSIONS		-		SEE CHART		B	
		DESIGN DIMENSION (PRIMARY) <input type="checkbox"/> (MM) <input type="checkbox"/> IN.				DWG NO.			
		EQUIVALENT DIMENSION (SECONDARY) <input type="checkbox"/> (MM) <input type="checkbox"/> IN.				SD-6471-N-...			

PART NO. SEE CHART  
 DWG. NO. SD-6471-N

HOUSING WITH OPTIONAL PEGS

PART No.	ENG No.	No. OF CIRCUITS	RAMP & POL. RIBS	DIM. A	DIM. B
NOT TOOLED	E-6471-7S	7	YES	↑	↑
↑	↑ -8S	8	↑	↑ SEE SHEET I FOR DIMENSION	↑ SEE SHEET I FOR DIMENSION
	-9S	9			
	-10S	10			
	-11S	11			
	-12S	12			
	-13S	13			
	-14S	14			
	-15S	15			
	-16S	16			
	-17S	17			
	-18S	18			
	-19S	19			
	-20S	20			
	-21S	21			
	-22S	22			
	-23S	23			
	-24S	24			
	-25S	25			
	-26S	26			
	↓ -27S	27	↓		
NOT TOOLED	E-6471-28S	28	YES	↓	↓

PART No.	ENG No.	No. OF CIRCUITS	RAMP & POL. RIBS	VOID CCT LOCATION	DIM. A	DIM. B		
22-01-4123	E-6471-12-11	12	NO	11	↑	↑		
22-01-4124	↑ -121-11	12	YES	11	↑ SEE SHEET I FOR DIMENSION	↑ SEE SHEET I FOR DIMENSION		
NOT TOOLED	-24-01	24	NO	1				
NOT TOOLED	-241-01	24	YES	1				
22-01-6132	-13-51	13	NO	2 & 5				
NOT TOOLED	-131-51	13	YES	2 & 5				
22-01-6134	-13-52	13	NO	9 & 12				
22-01-6135	-131-52	13	YES	9 & 12				
NOT TOOLED	-7-3	7	NO	3				
97-00-0739	-71-3	7	YES	3				
97-00-0061	-15-51	15	NO	2 & 8				
NOT TOOLED	-151-51	15	YES	2 & 8				
97-00-0189	-5-4	5	NO	4				
97-00-0620	-51-4	5	YES	4				
97-00-0619	↓ -51-3	5	YES	3				
97-00-0740	E-6471-61-3	6	YES	3			↓	↓

A SEE SHEET I.	LTR REVISIONS	DIMENSIONS SHOWN ( METRIC ) INCH UNLESS OTHERWISE SPECIFIED TOLERANCES: ANGULAR ± 1/2°	DRWG BY <b>SF</b>	REVISE ONLY ON CAD SYSTEM		SHL. REV.	
		INCH ( METRIC ) 3 PLACE ± . 2 PLACE ± . 1 PLACE ±	CHK'D BY	CAD/CAM FILENAME SD-6471-N - .504			THIS DRAWING CONTAINS INFORMATION THAT IS PROPRIETARY TO MOLEX INC. & SHOULD NOT BE USED WITHOUT WRITTEN PERMISSION
		DRAFT WHERE APPLICABLE MUST REMAIN WITHIN DIMENSIONS	APP'D BY	TITLE <b>2.54 mm KK Crp Trm Hsg II</b>			
		DESIGN DIMENSION <input type="checkbox"/> (MM) (PRIMARY) <input type="checkbox"/> IN.	SCALE	<b>MOLEX EUROPE</b>		SHEET NO. DATE <b>40F 17/07/00</b>	
EQUIVALENT DIMENSION <input type="checkbox"/> (MM) (SECONDARY) <input type="checkbox"/> IN.	-	PART NO. <b>SEE CHART</b>	DWG NO. <b>SD-6471-N-...</b>	SIZE <b>B</b>			

OPTIONAL STYLE VOID (SECTION E-E)

PART No.	ENG No.	No. OF CIRCUITS	VOID CCT LOCATION	RAMP & POL. RIBS	DIM. A	DIM. B
22-01-602I	E-6471-02-02B	2	2	NO	↑	↑
NOT TOOLED	↑ -02I-02B	2	↑	YES	↑ DIM	↑ DIM
22-01-607I	-07-02B	7		NO		
NOT TOOLED	↑ -07I-02B	7		YES		
22-01-610I	-10-02B	10		NO		
NOT TOOLED	↑ -10I-02B	10		YES		
22-01-611I	-11-02B	11		NO		
NOT TOOLED	↓ E-6471-11I-02B	11	↓ 2	YES	↓ SEE SHT. I FOR DIM	↓ SEE SHT. I FOR DIM

PART No.	ENG No.	No. OF CIRCUITS	RAMP ONLY	DIM. A	DIM. B
97-00-1062	E-6471-2R	2	YES	↑	↑
↑ -1063	↑ -3R	3	↑		
-1064	-4R	4			
-1065	-5R	5			
-1066	-6R	6			
-1067	-7R	7			
-1068	-8R	8			
-1069	-9R	9			
-1070	-10R	10			
-1071	-11R	11			
-1072	-12R	12			
-1073	-13R	13			
-1074	-14R	14			
-1075	-15R	15			
↓ -1076	-16R	16			
97-00-1077	-17R	17			
NOT TOOLED	-18R	18			
↑	-19R	19			
	-20R	20			
	-21R	21			
	-22R	22			
	-23R	23			
	-24R	24			
	-25R	25			
	-26R	26			
	↓ -27R	27			
NOT TOOLED	↓ E-6471-28R	28	YES	↓	↓

PART NO. SEE CHART  
 DRG. NO. SD-6471-N-...

SEE SHEET I.

LTR	REVISIONS	DIMENSIONS SHOWN ( METRIC ) INCH UNLESS OTHERWISE SPECIFIED TOLERANCES: ANGULAR ± 1/2°	DRWG BY <b>SF</b>
		INCH ( METRIC )	CHK'D BY
		3 PLACE ± .	APP'D BY
		2 PLACE ± .	SCALE
	1 PLACE ±	DRAFT WHERE APPLICABLE MUST REMAIN WITHIN DIMENSIONS	
		DESIGN DIMENSION <input type="checkbox"/> (MM) (PRIMARY) <input type="checkbox"/> IN.	
		EQUIVALENT DIMENSION <input type="checkbox"/> (MM) (SECONDARY) <input type="checkbox"/> IN.	

REVISE ONLY ON CAD SYSTEM		SHL. REV.
CAD/CAM FILENAME SD-6471-N - .505	THIS DRAWING CONTAINS INFORMATION THAT IS PROPRIETARY TO MOLEX INC. & SHOULD NOT BE USED WITHOUT WRITTEN PERMISSION	
TITLE <b>2.54 mm KK Cpr Trm Hsg II</b>		
MOLEX EUROPE	SHEET NO. DATE <b>50F 17/07/00</b>	
PART NO. <b>SEE CHART</b>	DWG NO. <b>SD-6471-N-...</b>	SIZE <b>B</b>

E

D

C

B

A

MM DIMENSIONS IN METRIC DO NOT SCALE DRAWING

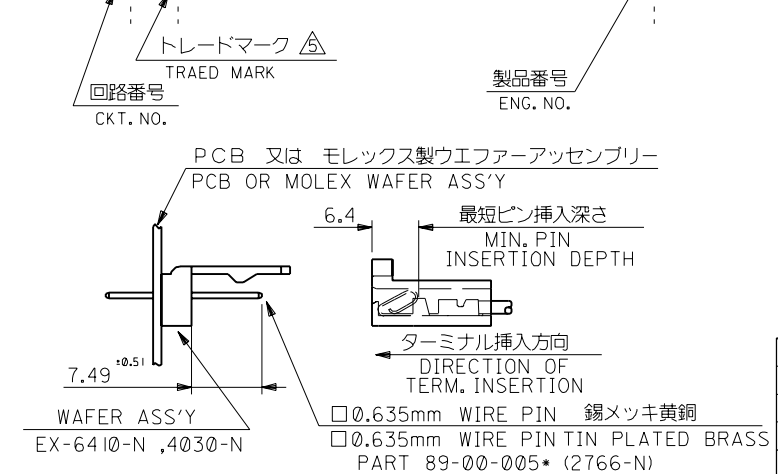
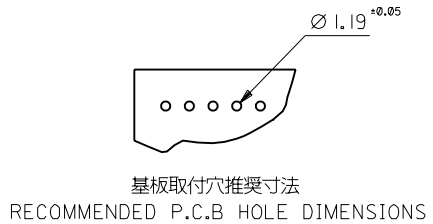
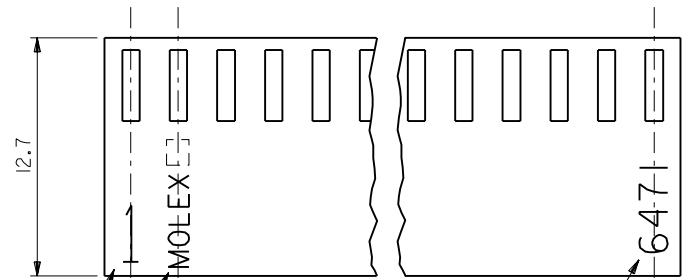
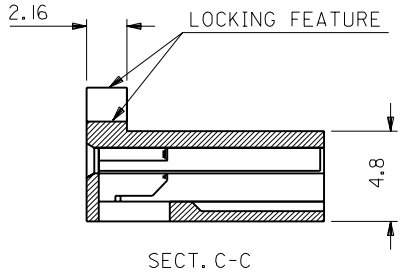
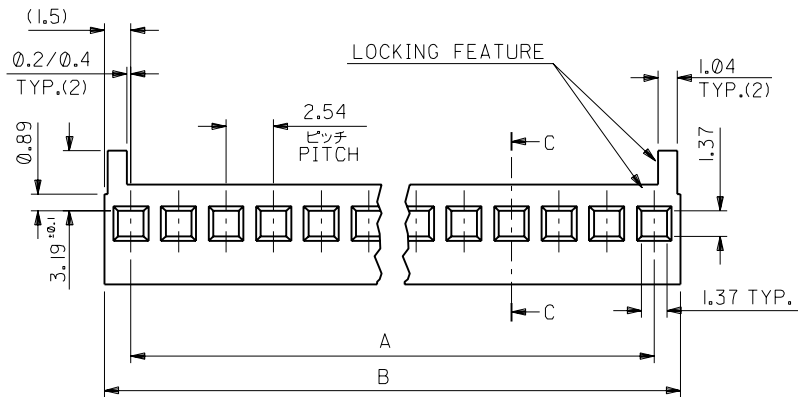

68.58 <sup>+0.33</sup>	71.58 <sup>+0.46</sup>	E-6471-281	28
66.04 <sup>+0.33</sup>	69.04 <sup>+0.46</sup>	-271	27
63.50 <sup>+0.33</sup>	66.50 <sup>+0.46</sup>	-261	26
60.96 <sup>+0.33</sup>	63.96 <sup>+0.43</sup>	-251	25
58.42 <sup>+0.31</sup>	61.42 <sup>+0.43</sup>	-241	24
55.88 <sup>+0.31</sup>	58.88 <sup>+0.43</sup>	-231	23
53.34 <sup>+0.30</sup>	56.34 <sup>+0.41</sup>	-221	22
50.80 <sup>+0.30</sup>	53.80 <sup>+0.41</sup>	-211	21
48.26 <sup>+0.25</sup>	51.26 <sup>+0.36</sup>	-201	20
45.72 <sup>+0.23</sup>	48.72 <sup>+0.33</sup>	-191	19
43.18 <sup>+0.23</sup>	46.18 <sup>+0.33</sup>	-181	18
40.64 <sup>+0.20</sup>	43.64 <sup>+0.30</sup>	-171	17
38.10 <sup>+0.20</sup>	41.10 <sup>+0.30</sup>	-161	16
35.56 <sup>+0.20</sup>	38.56 <sup>+0.30</sup>	-151	15
33.02 <sup>+0.18</sup>	36.42 <sup>+0.28</sup>	-141	14
30.48 <sup>+0.18</sup>	33.48 <sup>+0.28</sup>	-131	13
27.94 <sup>+0.18</sup>	30.94 <sup>+0.28</sup>	-121	12
25.40 <sup>+0.15</sup>	28.40 <sup>+0.25</sup>	-111	11
22.86 <sup>+0.15</sup>	25.86 <sup>+0.25</sup>	-101	10
20.32 <sup>+0.13</sup>	23.32 <sup>+0.23</sup>	-091	9
17.78 <sup>+0.13</sup>	20.78 <sup>+0.23</sup>	-081	8
15.24 <sup>+0.13</sup>	18.24 <sup>+0.23</sup>	-071	7
12.70 <sup>+0.10</sup>	15.70 <sup>+0.23</sup>	-061	6
10.16 <sup>+0.10</sup>	13.16 <sup>+0.20</sup>	-051	5
7.62 <sup>+0.10</sup>	10.62 <sup>+0.20</sup>	-041	4
5.08 <sup>+0.10</sup>	8.07 <sup>+0.20</sup>	-031	3
2.54 <sup>+0.10</sup>	5.53 <sup>+0.20</sup>	E-6471-021	2
A	B	ENG. NO.	通数 NO. OF CKTS.

角度 ANGLE	±3°
30°以上 OVER	+0.3
10°以上 30°未満 UNDER	+0.25
10°未満 UNDER	+0.2
公差 GENERAL TOLERANCES	記号 LTR 変更内容 REVISION RECORD DR. Y.M 日付 DATE 97/09/18

材料 MATERIAL	ナイロン6/6, UL94V-0 NYLON6/6, UL94V-0
仕上げ FINISH	—//—
適用電線範囲 WIRE RANGE	—//—
被覆外径 INS. RANGE	—//—
DRAWN BY	Y.KANNO
CHK'D BY	Y.MIZUNO
APP'D BY	M.FUKUSHIMA
尺度 SCALE	—//—

MOLEX-JAPAN CO.,LTD. 日本モレックス株式会社	
REVISE ONLY ON CAD SYSTEM	
TITLE 名称 HOUSING ,KK (2.54)/.100 CRIMP TYPE ,ANTI FISH-HOOKING TERMINAL WITH LOCKING RAMP	
DWG. NO.	SHEET 1 OF 2
SDE-6471-N**	REV V

E

D

MM DIMENSIONS IN METRIC DO NOT SCALE DRAWING

B

A

22-01 -2285	E-6471-281	28	○	↑	↑
設備無し NOT TOOLED	↑ -271	27	↑		
22-01 -2265	-261	26			
設備無し NOT TOOLED	-251	25			
22-01 -2245	-241	24			
↑ -2235	-231	23			
-2225	-221	22			
-2215	-211	21			
-2205	-201	20		図面 1 OF 2 参照	参照
-2195	-191	19		SEE SHEET 1 OF 2	参照
-2185	-181	18			
-2175	-171	17		図面 1 OF 2 参照	参照
-2165	-161	16			
-2155	-151	15		図面 1 OF 2 参照	参照
-2145	-141	14			
-2135	-131	13			
-2125	-121	12			
-2115	-111	11			
-2105	-101	10			
-2095	-091	9			
-2085	-081	8			
-2075	-071	7			
-2065	-061	6			
-2055	-051	5			
-2045	-041	4			
↓ -2035	↓ -031	3	○	↓	↓
22-01 -2025	E-6471-021	2	○		
PART NO.	ENG. NO.	種数 NO. OF CKTS.	補助部 RAMP & POL.RIBS	A	B

注記  
NOTES

- 適合ターミナル 4809-\* (22-30 GA)  
クリンプ部 被覆外径  $\phi 1.58\text{mm}$ 以下  
FOR USE TERMINAL 4809-\* (22-30 GA)  
CRIMP TYPE ,MAX. INSULATION  $\phi 1.58\text{mm}$
- ハウジングの端と端を合わせて積み重ねることができる。  
TWO(2) HOUSINGS MAY BE STACKED END TO END.
- ( ) 内寸法は参考寸法  
( ) DIMENSION IS FOR REFERENCE.
- 本製品は仕様書NO. 10-07に基づく。  
THIS PART CONFORMS TO MOLEX PRODUCT SPEC. NO.10-07
- △トレードマーク：MOLEX プラス1文字の製造国を示すアルファベットにて構成。  
(例：I =アイルランド)  
TRADE MARK FORMED BY MOLEX AND I MORE LETTER OF ALPHABET  
WHICH MEAN THE MANUFACTURING COUNTRY. (c.g. I=IRELAND)
- 19から28極は標準品ではありません。  
19-28 CIRCUITS ARE NON-STANDARD.
- 一般公差： $\pm 0.4$   
GENERAL TOLERANCES:  $\pm 0.4$

角度 ANGLE		材料 MATERIAL	
30 以上 OVER	+0.3	ナイロン6/6, UL94V-0	
10 以上 OVER 30 未満 UNDER	+0.25	NYLON6/6, UL94V-0	
10 未満 UNDER	+0.2	仕上げ FINISH	
一般公差 GENERAL TOLERANCES		適用電線範囲 WIRE RANGE	
		被覆外径 INS. RANGE	
		DRAWN BY '97/09/18 Y.KANNO	
		CHK'D BY '97/09/19 Y.MIZUNO	
		APP'D BY '97/09/19 M.FUKUSHIMA	
		尺 度 SCALE	
		新規作成 RELEASED (JC80224) Y.K. '97/09/18	
		変更内容 DR. '97/09/18	
		日付 CHK. DATE	

MOLEX-JAPAN CO.,LTD. 日本モレックス株式会社

REVISE ONLY ON CAD SYSTEM

TITLE 名称  
HOUSING ,KK (2.54)/.100  
CRIMP TYPE ,ANTI  
FISH-HOOKING TERMINAL  
WITH LOCKING RAMP

DWG. NO. SHEET 2 OF 2 REV  
SDE-6471-N\*-\*



PART NO. SEE CHART  
DWG. NO. SDE-6472-N\*D-A

NO OF CCTS	COLOUR BLACK	
	WITHOUT RAMP OR RIBS	
	TOOLING	PART NO.
2	NOT TOOLED	E-6471-2D-A
3	NOT TOOLED	E-6471-3D-A
4	NOT TOOLED	E-6471-4D-A
5	97-00-0183	E-6471-5D-A

SEE SHEET 1 EC NO. E80448 DRWN: MCASEY 98/05/14 CH'K: / / / APPR: / / /	QUALITY SYMBOLS = MAJOR = CRITICAL	GENERAL TOLERANCES: (UNLESS SPECIFIED) <table border="1"> <tr> <td></td> <td>mm</td> <td>INCH</td> </tr> <tr> <td>4 PLACES</td> <td>±0.</td> <td>±.</td> </tr> <tr> <td>3 PLACES</td> <td>±0.</td> <td>±.</td> </tr> <tr> <td>2 PLACES</td> <td>±0.</td> <td>±.</td> </tr> <tr> <td>1 PLACE</td> <td>±0.</td> <td>±.</td> </tr> </table>		mm	INCH	4 PLACES	±0.	±.	3 PLACES	±0.	±.	2 PLACES	±0.	±.	1 PLACE	±0.	±.	SCALE : DESIGN UNITS <input type="checkbox"/> mm <input type="checkbox"/> INCH	DRAWN BY & DATE MCASEY 98/05/14 CHECKED BY & DATE OCOSTELL 98/05/14 APPROVED BY & DATE MWHILITE 98/05/14	DIMENSIONS: <input type="checkbox"/> mm <input type="checkbox"/> INCH <input type="checkbox"/> mm ONLY <input type="checkbox"/> mm <input type="checkbox"/> INCH <input type="checkbox"/> mm ONLY	THIRD ANGLE PROJECTION 	SHT REV
		mm	INCH																			
	4 PLACES	±0.	±.																			
	3 PLACES	±0.	±.																			
2 PLACES	±0.	±.																				
1 PLACE	±0.	±.																				
DESCRIPTION REV	ANGLUAR: ± 1/2° DRAFT WHERE APPLICABLE MUST REMAIN WITHIN DIMENSIONS	CAD FILENAME S6471X2.DGN	MATERIAL NO. SEE CHART	DRAWING NO. SDE-6471-N*D-A	SHEET NO. 2 OF	SIZE B																
TITLE: HOUSING K-K(2.54)/.100 ANTI FISK HOOKING TERM OPT. LOCK&COL FEAT							REVISE ON CAD ONLY															
MOLEX INCORPORATED 							THIS DRAWING CONTAINS INFORMATION THAT IS PROPRIETARY TO MOLEX INCORPORATED AND SHOULD NOT BE USED WITHOUT WRITTEN PERMISSION.															