

**PLEASE CHECK WWW.MOLEX.COM FOR LATEST PART INFORMATION**

**Part Number:** [0310681040](#)  
**Status:** **Active**  
**Overview:** H-DAC™ 64 Single Row  
**Description:** 2.54mm (.100") H-DAC 64™, 4 Way Male Housing Assembly, Single-Row, Polarization A

**Documents:**

[Drawing \(PDF\)](#) [Product Specification PS-31067-0001 \(PDF\)](#)  
[Application Specification \(PDF\)](#) [RoHS Certificate of Compliance \(PDF\)](#)

**General**

Product Family	Crimp Housings
Series	31068
Comments	Polarization Option A, Black
Overview	H-DAC™ 64 Single Row
Product Name	H-DAC 64™

**Physical**

Circuits (maximum)	4
Circuits Detail	4
Color - Resin	Black
Gender	Male
Glow-Wire Compliant	No
Keying to Mating Part	None
Lock to Mating Part	Yes
Material - Resin	Modified Polystyrene, Polyester
Number of Rows	1
Packaging Type	Bag
Panel Mount	No
Pitch - Mating Interface (in)	0.100 In
Pitch - Mating Interface (mm)	2.54 mm
Pitch - Term. Interface (in)	0.100 In
Pitch - Term. Interface (mm)	2.54 mm
Polarized to Mating Part	Yes
Ports	1
Stackable	No
Temperature Range - Operating	-40°C to +100°C

**Electrical**

Current - Maximum per Contact	11A, 9A
-------------------------------	---------

**Material Info**

**Reference - Drawing Numbers**

Product Specification	PS-31067-0001
Sales Drawing	SD-31110-003

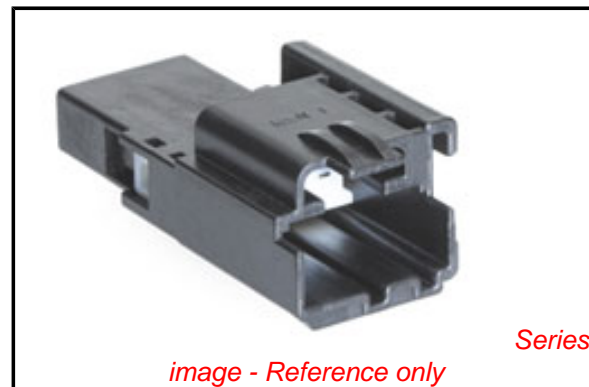

*image - Reference only*

**EU RoHS**

**ELV and RoHS Compliant**  
**REACH SVHC Contains SVHC: No**  
**Halogen-Free Status**  
**Not Reviewed**

**China RoHS**



**Need more information on product environmental compliance?**

Email [productcompliance@molex.com](mailto:productcompliance@molex.com)  
 For a multiple part number RoHS Certificate of Compliance, [click here](#)

Please visit the [Contact Us](#) section for any non-product compliance questions.

**Search Parts in this Series**

31068Series

**Mates With**

H-DAC 64™, 4 Way Receptacle Assembly  
 310681010

**Use With**

See Product Spec

3 WAY MALE HOUSING ASSEMBLY  
WITHOUT XMAS TREE  
(VIEWED FROM MATE SIDE)

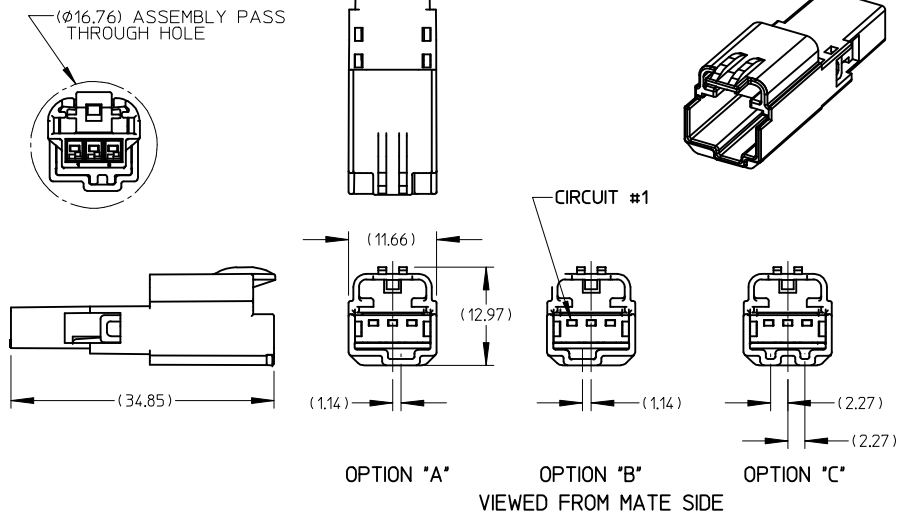

5 WAY MALE HOUSING ASSEMBLY  
WITHOUT XMAS TREE  
(VIEWED FROM MATE SIDE)

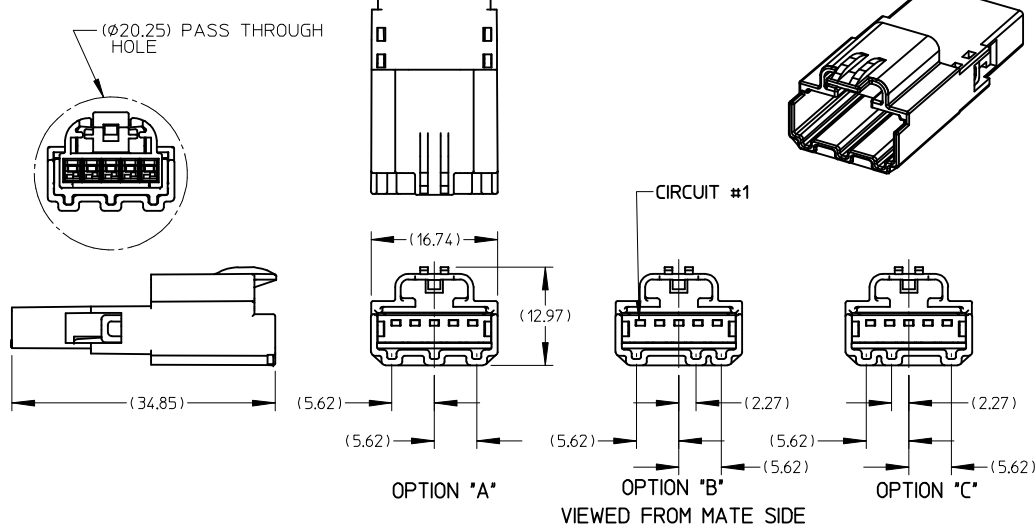

4 WAY MALE HOUSING ASSEMBLY  
WITHOUT XMAS TREE  
(VIEWED FROM MATE SIDE)

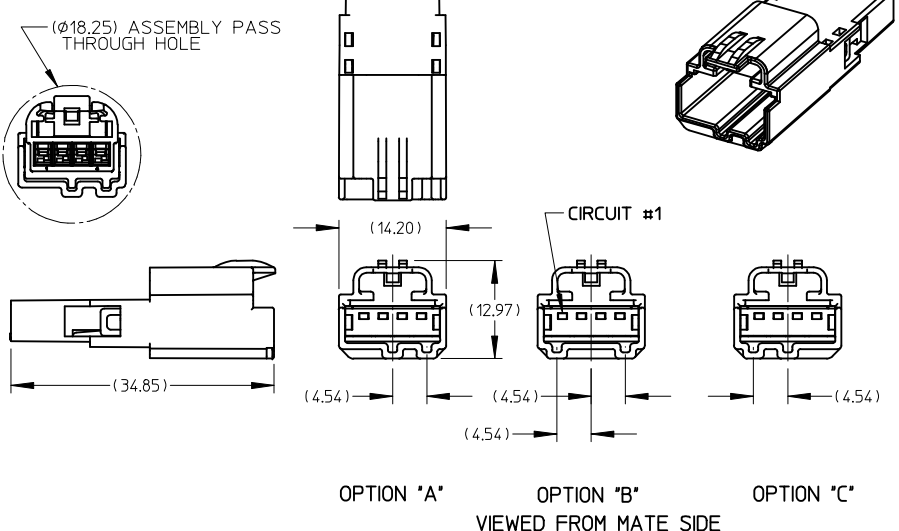

6 WAY MALE HOUSING ASSEMBLY  
WITHOUT XMAS TREE  
(VIEWED FROM MATE SIDE)

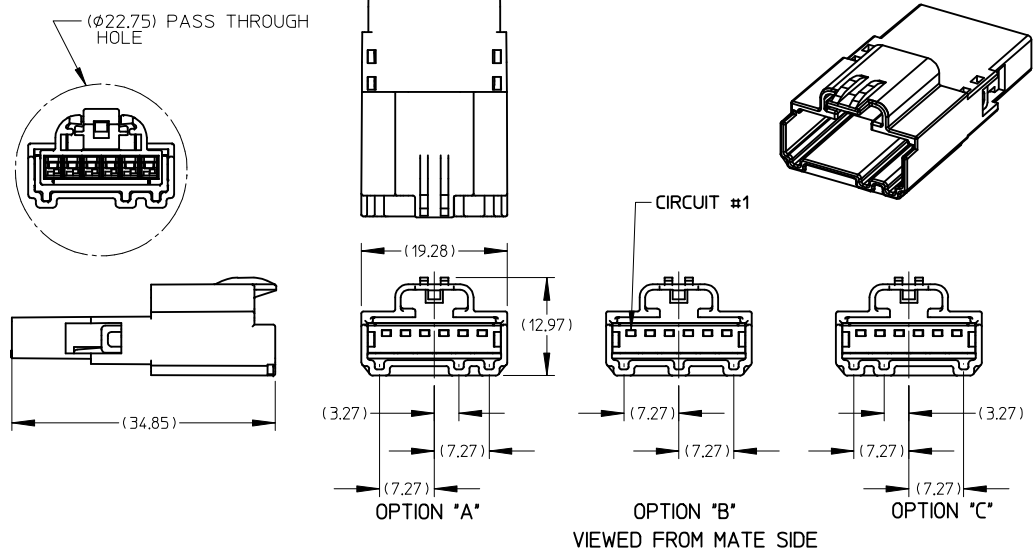

- NOTES:
1. MATERIAL: HOUSING: SPS GLASS FILLED, COLOR SEE CHART.  
TPA: PBT.
  2. PRODUCT SPECIFICATION: PS-31067-0001.
  3. PACKAGING SPECIFICATION: DRAWING PK-31301-067.
  4. MATES WITH: SEE SALES DRAWINGS SD-31109-003.

EC NO: UAU2009-1155  
DRWN: THERUF02009/05/12  
CHK: TANGELI2009/05/14  
APPR: MKNACK 2009/05/14

QUALITY SYMBOLS	DESCRIPTION
▽-0	
▽C-0	

GENERAL TOLERANCES (UNLESS SPECIFIED)	
	mm INCH
4 PLACES ±	--- ± ---
3 PLACES ±	--- ± ---
2 PLACES ±	0.13 ± ---
1 PLACE ±	0.25 ± ---
ANGULAR ± 1/2 °	
DRAFT WHERE APPLICABLE MUST REMAIN WITHIN DIMENSIONS	

SCALE 2:1	DESIGN UNITS METRIC
DIMENSION STYLE MM ONLY	
DRAWN BY	DATE
DEMOE	01/04/04
CHECKED BY	DATE
APPROVED BY	DATE

THIRD ANGLE PROJECTION

REVISE ON CAD ONLY

MALE ASSEMBLY  
CHARTED SALES DRAWING

**MOLEX** MOLEX INCORPORATED

MATERIAL NO. SEE CHART

DOCUMENT NO. SD-31110-003

SHEET NO. 1 OF 3

THIS DRAWING CONTAINS INFORMATION THAT IS PROPRIETARY TO MOLEX INCORPORATED AND SHOULD NOT BE USED WITHOUT WRITTEN PERMISSION

3 WAY MALE HOUSING ASSEMBLY WITH XMAS TREE (VIEWED FROM MATE SIDE)

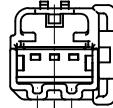
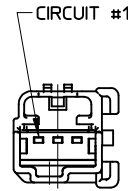
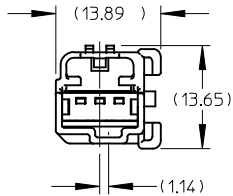
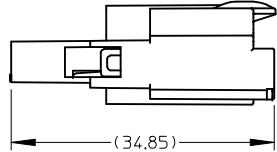
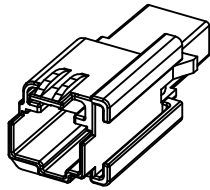
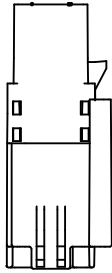

OPTION "A"

OPTION "B" VIEWED FROM MATE SIDE

OPTION "C"

(13.89)  
(13.65)  
(1.14)  
(1.14)  
(2.27)  
(2.27)

5 WAY MALE HOUSING ASSEMBLY WITH XMAS TREE (VIEWED FROM MATE SIDE)

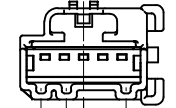
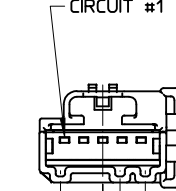
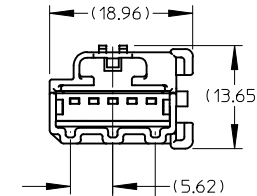
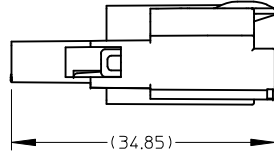
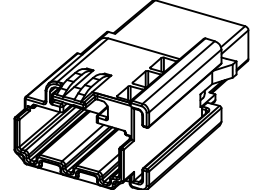
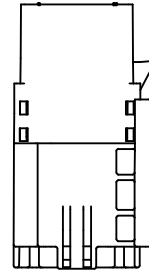

OPTION "A"

OPTION "B" VIEWED FROM MATE SIDE

OPTION "C"

(18.96)  
(13.65)  
(5.62)  
(5.62)  
(2.27)  
(2.27)  
(5.62)  
(5.62)

5 WAY MALE HOUSING ASSEMBLY WITH XMAS TREE

4 WAY MALE HOUSING ASSEMBLY WITH XMAS TREE (VIEWED FROM MATE SIDE)

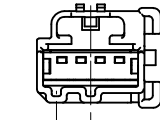
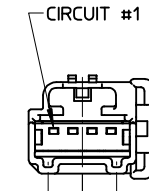
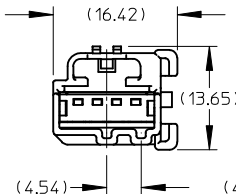
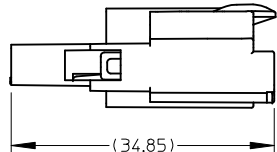
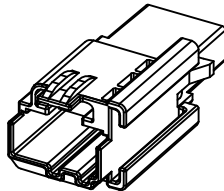
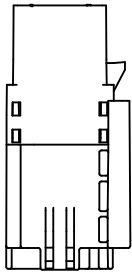

OPTION "A"

OPTION "B" VIEWED FROM MATE SIDE

OPTION "C"

(16.42)  
(13.65)  
(4.54)  
(4.54)  
(4.54)  
(4.54)

4 WAY MALE HOUSING ASSEMBLY WITH XMAS TREE

6 WAY MALE HOUSING ASSEMBLY WITH XMAS TREE (VIEWED FROM MATE SIDE)

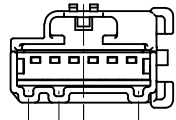
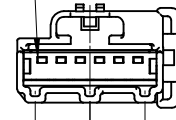
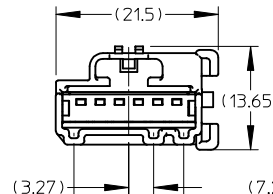
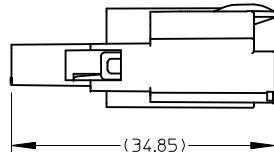
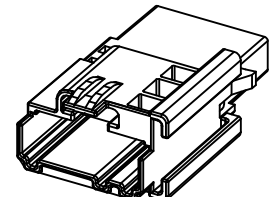
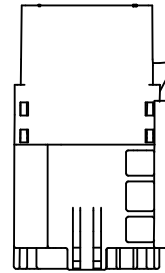

OPTION "A"

OPTION "B" VIEWED FROM MATE SIDE

OPTION "C"

(21.5)  
(13.65)  
(3.27)  
(7.27)  
(7.27)  
(7.27)  
(7.27)  
(7.27)

6 WAY MALE HOUSING ASSEMBLY WITH XMAS TREE

EC NO: UAU2009-1155  
DRWN: THERFURT009/05/12  
CHKD: TSMITH 2009/05/14  
APPR: TANGELLO2009/05/14

QUALITY SYMBOLS	GENERAL TOLERANCES (UNLESS SPECIFIED)	
▽ = 0	mm	INCH
	4 PLACES ± ---	± ---
▽C = 0	3 PLACES ± ---	± ---
	2 PLACES ± 0.13	± ---
	1 PLACE ± 0.25	± ---
	ANGULAR ± 1/2°	

DRAFT WHERE APPLICABLE  
MUST REMAIN WITHIN DIMENSIONS

SCALE 2:1  
DESIGN UNITS METRIC  
DIMENSION STYLE MM ONLY  
DRAWN BY DATE  
DEMOE 01/04/04  
CHECKED BY DATE  
APPROVED BY DATE

THIRD ANGLE PROJECTION  
REVISE ON CAD ONLY  
TITLE  
MALE ASSEMBLY CHARTED SALES DRAWING  
Molex MOLEX INCORPORATED  
MATERIAL NO. ENTER-PART  
DOCUMENT NO. SD-3110-003  
SHEET NO. 2 OF 3

BILL OF MATERIALS

BILL OF MATERIALS

ASSEMBLY PART NUMBER	DESCRIPTION	XMAS TREE ATTACHMENT FEATURE	PART NUMBER	DESCRIPTION	COLOR
31067-1040	3 WAY MALE ASSEMBLY POLARIZATION "A"	NO	31112-0030	MALE HOUSING	BLACK
			31114-0030	TPA	NATURAL (WHITE)
31067-1041	3 WAY MALE ASSEMBLY POLARIZATION "B"	NO	31112-0031	MALE HOUSING	GRAY
			31114-0030	TPA	NATURAL (WHITE)
31067-1042	3 WAY MALE ASSEMBLY POLARIZATION "C"	NO	31112-0032	MALE HOUSING	BROWN
			31114-0030	TPA	NATURAL (WHITE)
31067-1070	3 WAY MALE ASSEMBLY POLARIZATION "A"	YES	31112-1030	MALE HOUSING	BLACK
			31114-0030	TPA	NATURAL (WHITE)
31067-1071	3 WAY MALE ASSEMBLY POLARIZATION "B"	YES	31112-1031	MALE HOUSING	GRAY
			31114-0030	TPA	NATURAL (WHITE)
31067-1072	3 WAY MALE ASSEMBLY POLARIZATION "C"	YES	31112-1032	MALE HOUSING	BROWN
			31114-0030	TPA	NATURAL (WHITE)
31068-1040	4 WAY MALE ASSEMBLY POLARIZATION "A"	NO	31166-0040	MALE HOUSING	BLACK
			31167-0040	TPA	NATURAL (WHITE)
31068-1041	4 WAY MALE ASSEMBLY POLARIZATION "B"	NO	31166-0031	MALE HOUSING	GRAY
			31167-0040	TPA	NATURAL (WHITE)
31068-1042	4 WAY MALE ASSEMBLY POLARIZATION "C"	NO	31166-0032	MALE HOUSING	BROWN
			31167-0040	TPA	NATURAL (WHITE)
31068-1070	4 WAY MALE ASSEMBLY POLARIZATION "A"	YES	31166-1040	MALE HOUSING	BLACK
			31167-0040	TPA	NATURAL (WHITE)
31068-1071	4 WAY MALE ASSEMBLY POLARIZATION "B"	YES	31166-1041	MALE HOUSING	GRAY
			31167-0040	TPA	NATURAL (WHITE)
31068-1072	4 WAY MALE ASSEMBLY POLARIZATION "C"	YES	31166-1042	MALE HOUSING	BROWN
			31167-0040	TPA	NATURAL (WHITE)

ASSEMBLY PART NUMBER	DESCRIPTION	XMAS TREE ATTACHMENT FEATURE	PART NUMBER	DESCRIPTION	COLOR
31072-1040	5 WAY MALE ASSEMBLY POLARIZATION "A"	NO	31169-0050	MALE HOUSING	BLACK
			31170-0050	TPA	NATURAL (WHITE)
31072-1041	5 WAY MALE ASSEMBLY POLARIZATION "B"	NO	31169-0051	MALE HOUSING	GRAY
			31170-0050	TPA	NATURAL (WHITE)
31072-1042	5 WAY MALE ASSEMBLY POLARIZATION "C"	NO	31169-0052	MALE HOUSING	BROWN
			31170-0050	TPA	NATURAL (WHITE)
31072-1070	5 WAY MALE ASSEMBLY POLARIZATION "A"	YES	31169-1050	MALE HOUSING	BLACK
			31170-0050	TPA	NATURAL (WHITE)
31072-1071	5 WAY MALE ASSEMBLY POLARIZATION "B"	YES	31169-1051	MALE HOUSING	GRAY
			31170-0050	TPA	NATURAL (WHITE)
31072-1072	5 WAY MALE ASSEMBLY POLARIZATION "C"	YES	31169-1052	MALE HOUSING	BROWN
			31170-0050	TPA	NATURAL (WHITE)
31073-1040	6 WAY MALE ASSEMBLY POLARIZATION "A"	NO	31172-0060	MALE HOUSING	BLACK
			31173-0060	TPA	NATURAL (WHITE)
31073-1041	6 WAY MALE ASSEMBLY POLARIZATION "B"	NO	31172-0061	MALE HOUSING	GRAY
			31173-0060	TPA	NATURAL (WHITE)
31073-1042	6 WAY MALE ASSEMBLY POLARIZATION "C"	NO	31172-0062	MALE HOUSING	BROWN
			31173-0060	TPA	NATURAL (WHITE)
31073-1070	6 WAY MALE ASSEMBLY POLARIZATION "A"	YES	31172-1060	MALE HOUSING	BLACK
			31173-0060	TPA	NATURAL (WHITE)
31073-1071	6 WAY MALE ASSEMBLY POLARIZATION "B"	YES	31172-1061	MALE HOUSING	GRAY
			31173-0060	TPA	NATURAL (WHITE)
31073-1072	6 WAY MALE ASSEMBLY POLARIZATION "C"	YES	31172-1062	MALE HOUSING	BROWN
			31173-0060	TPA	NATURAL (WHITE)

EC NO: UAU2009-1155 DRWN: THERFU2009/05/12 CHK: TANGELL2009/05/14 APPR: MKNACK 2009/05/14	QUALITY SYMBOLS	GENERAL TOLERANCES (UNLESS SPECIFIED)		SCALE 2:1	DESIGN UNITS METRIC	THIRD ANGLE PROJECTION	REVISE ON CAD ONLY
	▽ - 0 ▽ - 0	mm		DIMENSION STYLE MM ONLY		MALE ASSEMBLY CHARTED SALES DRAWING	
		4 PLACES ± --- ± ---	DRAWN BY DATE		MOLEX INCORPORATED MATERIAL NO. SEE CHART DOCUMENT NO. SD-31110-003 SHEET NO. 3 OF 3		
		3 PLACES ± --- ± ---	DEMO 01/04/04				
2 PLACES ± 0.13 ± ---	CHECKED BY DATE		APPROVED BY DATE		THIS DRAWING CONTAINS INFORMATION THAT IS PROPRIETARY TO MOLEX INCORPORATED AND SHOULD NOT BE USED WITHOUT WRITTEN PERMISSION		
1 PLACE ± 0.25 ± ---	ANGULAR ± 1/2 °		DRAFT WHERE APPLICABLE MUST REMAIN WITHIN DIMENSIONS				