

Power SMD LED PLCC-4

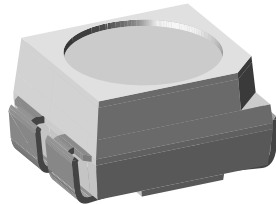

19210

DESCRIPTION

The TLM.32. is an advanced development in terms of heat dissipation.

The leadframe profile of this PLCC-4 SMD package is optimized to reduce the thermal resistance.

This allows higher drive current and doubles the light output compared to Vishay's high intensity SMD LED in PLCC-2 package.

PRODUCT GROUP AND PACKAGE DATA

- Product group: LED
- Package: SMD PLCC-4
- Product series: power
- Angle of half intensity: $\pm 60^\circ$

FEATURES

- Available in 8 mm tape
- Luminous intensity and color categorized per packing unit
- Luminous intensity ratio per packing unit $I_{Vmax}/I_{Vmin} \leq 1.6$
- ESD-withstand voltage: up to 2 kV according to JESD22-A114-B
- Suitable for all soldering methods according to CECC 00802 and J-STD-020C
- Preconditioning: acc. to JEDEC level 2a
- Lead (Pb)-free device
- Component in accordance to RoHS 2002/95/EC and WEEE 2002/96/EC



APPLICATIONS

- Interior and exterior lighting
- Indicator and backlighting purposes for audio, video, LCDs, switches, symbols, illuminated advertising etc.
- Illumination purpose, alternative to incandescent lamps
- General use

PARTS TABLE

PART	COLOR, LUMINOUS INTENSITY	TECHNOLOGY
TLMK32T2V1-GS18	Red, $I_V = (355 \text{ to } 900) \text{ mcd}$	AllnGaP on GaAs
TLMK32U2AA-GS18	Red, $I_V = (560 \text{ to } 1400) \text{ mcd}$	AllnGaP on GaAs
TLMK32T2AA-GS18	Red, $I_V = (355 \text{ to } 1400) \text{ mcd}$	AllnGaP on GaAs
TLMS32S2U1-GS18	Super red, $I_V = (224 \text{ to } 560) \text{ mcd}$	AllnGaP on GaAs
TLMS32T1U2-GS18	Super red, $I_V = (280 \text{ to } 710) \text{ mcd}$	AllnGaP on GaAs
TLMS32S2V1-GS18	Super red, $I_V = (224 \text{ to } 900) \text{ mcd}$	AllnGaP on GaAs
TLMO32U2AA-GS18	Soft orange, $I_V = (560 \text{ to } 1400) \text{ mcd}$	AllnGaP on GaAs
TLMO32T2V1-GS18	Soft orange, $I_V = (355 \text{ to } 900) \text{ mcd}$	AllnGaP on GaAs
TLMO32U1AA-GS18	Soft orange, $I_V = (450 \text{ to } 1400) \text{ mcd}$	AllnGaP on GaAs
TLMY32T2V1-GS18	Yellow, $I_V = (355 \text{ to } 900) \text{ mcd}$	AllnGaP on GaAs
TLMY32U2AA-GS18	Yellow, $I_V = (560 \text{ to } 1400) \text{ mcd}$	AllnGaP on GaAs
TLMY32T2AA-GS18	Yellow, $I_V = (355 \text{ to } 1400) \text{ mcd}$	AllnGaP on GaAs



ABSOLUTE MAXIMUM RATINGS ¹⁾ TLMK32., TLMS32., TLMO32., TLMY32.				
PARAMETER	TEST CONDITION	SYMBOL	VALUE	UNIT
Reverse voltage ²⁾		V_R	5	V
Forward current		I_F	70	mA
Power dissipation		P_{tot}	180	mW
Junction temperature		T_j	125	°C
Operating temperature range		T_{amb}	- 40 to + 100	°C
Storage temperature range		T_{stg}	- 40 to + 100	°C
Thermal resistance junction/ambient	mounted on PC board FR4 optional padderdesign	R_{thJA}	290	K/W
	mounted on PC board FR4 recommended padderdesign	R_{thJA}	270	K/W

Note:

- 1) $T_{amb} = 25\text{ °C}$, unless otherwise specified
- 2) Driving the LED in reverse direction is suitable for short term application

OPTICAL AND ELECTRICAL CHARACTERISTICS ¹⁾ TLMK32., RED							
PARAMETER	TEST CONDITION	PART	SYMBOL	MIN.	TYP.	MAX.	UNIT
Luminous intensity ²⁾	$I_F = 50\text{ mA}$	TLMK32T2V1	I_V	355		900	mcd
		TLMK32U2AA	I_V	560		1400	mcd
		TLMK32T2AA	I_V	355		1400	mcd
Luminous flux			ϕ_V/I_V		3		mlm/mcd
Dominant wavelength	$I_F = 50\text{ mA}$	TLMK32..	λ_d	612	617	624	nm
Peak wavelength	$I_F = 50\text{ mA}$		λ_p		624		nm
Spectral bandwidth at 50 % $I_{rel\ max}$	$I_F = 50\text{ mA}$		$\Delta\lambda$		18		nm
Angle of half intensity	$I_F = 50\text{ mA}$		ϕ		± 60		deg
Forward voltage ³⁾	$I_F = 50\text{ mA}$		V_F	1.85	2.1	2.55	V
Reverse current	$V_R = 5\text{ V}$		I_R		0.01	10	μA

Note:

- 1) $T_{amb} = 25\text{ °C}$, unless otherwise specified
- 2) In one packing unit $I_{Vmax}/I_{Vmin} \leq 1.6$
- 3) Forward voltage is tested at a current pulse duration of 1 ms and a tolerance of $\pm 0.05\text{ V}$

OPTICAL AND ELECTRICAL CHARACTERISTICS ¹⁾ TLMS32., SUPER RED							
PARAMETER	TEST CONDITION	PART	SYMBOL	MIN.	TYP.	MAX.	UNIT
Luminous intensity ²⁾	$I_F = 50\text{ mA}$	TLMS32S2U1	I_V	224		560	mcd
		TLMS32T1U2	I_V	280		710	mcd
		TLMS32S2V1	I_V	224		900	mcd
Luminous flux			ϕ_V/I_V		3		mlm/mcd
Dominant wavelength	$I_F = 50\text{ mA}$		λ_d	626	630	638	nm
Peak wavelength	$I_F = 50\text{ mA}$		λ_p		641		nm
Spectral bandwidth at 50 % $I_{rel\ max}$	$I_F = 50\text{ mA}$		$\Delta\lambda$		17		nm
Angle of half intensity	$I_F = 50\text{ mA}$		ϕ		± 60		deg
Forward voltage ³⁾	$I_F = 50\text{ mA}$		V_F	1.85	2.1	2.55	V
Reverse current	$V_R = 5\text{ V}$		I_R		0.01	10	μA

Note:

- 1) $T_{amb} = 25\text{ °C}$, unless otherwise specified
- 2) In one packing unit $I_{Vmax}/I_{Vmin} \leq 1.6$
- 3) Forward voltage is tested at a current pulse duration of 1 ms and a tolerance of $\pm 0.05\text{ V}$



OPTICAL AND ELECTRICAL CHARACTERISTICS ¹⁾ TLMO32., SOFT ORANGE							
PARAMETER	TEST CONDITION	PART	SYMBOL	MIN.	TYP.	MAX.	UNIT
Luminous intensity ²⁾	$I_F = 50 \text{ mA}$	TLMO32T2V1	I_V	355		900	mcd
		TLMO32U2AA	I_V	560		1400	mcd
		TLMO32U1AA	I_V	450		1400	mcd
Luminous flux			ϕ_V/I_V		3		mlm/mcd
Dominant wavelength	$I_F = 50 \text{ mA}$		λ_d	600	605	609	nm
Peak wavelength	$I_F = 50 \text{ mA}$		λ_p		611		nm
Spectral bandwidth at 50 % $I_{rel \text{ max}}$	$I_F = 50 \text{ mA}$		$\Delta\lambda$		17		nm
Angle of half intensity	$I_F = 50 \text{ mA}$		φ		± 60		deg
Forward voltage ³⁾	$I_F = 50 \text{ mA}$		V_F	1.85	2.1	2.55	V
Reverse current	$V_R = 5 \text{ V}$		I_R		0.01	10	μA

Note:

¹⁾ $T_{amb} = 25 \text{ }^\circ\text{C}$, unless otherwise specified

²⁾ In one packing unit $I_{Vmax}/I_{Vmin} \leq 1.6$

³⁾ Forward voltage is tested at a current pulse duration of 1 ms and a tolerance of $\pm 0.05 \text{ V}$

OPTICAL AND ELECTRICAL CHARACTERISTICS ¹⁾ TLMY3214, YELLOW							
PARAMETER	TEST CONDITION	PART	SYMBOL	MIN.	TYP.	MAX.	UNIT
Luminous intensity ²⁾	$I_F = 50 \text{ mA}$	TLMY32T2V1	I_V	355		900	mcd
		TLMY32U2AA	I_V	560		1400	mcd
		TLMY32T2AA	I_V	355		1400	mcd
Luminous flux			ϕ_V/I_V		3		mlm/mcd
Dominant wavelength	$I_F = 50 \text{ mA}$		λ_d	580	588	595	nm
Peak wavelength	$I_F = 50 \text{ mA}$		λ_p		590		nm
Spectral bandwidth at 50 % $I_{rel \text{ max}}$	$I_F = 50 \text{ mA}$		$\Delta\lambda$		18		nm
Angle of half intensity	$I_F = 50 \text{ mA}$		φ		± 60		deg
Forward voltage ³⁾	$I_F = 50 \text{ mA}$		V_F	1.85	2.1	2.55	V
Reverse current	$V_R = 5 \text{ V}$		I_R		0.01	10	μA

Note:

¹⁾ $T_{amb} = 25 \text{ }^\circ\text{C}$, unless otherwise specified

²⁾ In one packing unit $I_{Vmax}/I_{Vmin} \leq 1.6$

³⁾ Forward voltage is tested at a current pulse duration of 1 ms and a tolerance of $\pm 0.05 \text{ V}$

LUMINOUS INTENSITY CLASSIFICATION			
GROUP	LIGHT INTENSITY (MCD)		
	STANDARD	OPTIONAL	MIN. MAX.
S	1	180	224
	2	224	280
T	1	280	355
	2	355	450
U	1	450	560
	2	560	710
V	1	710	900
	2	900	1120
A	A	1120	1400

Note:

Luminous intensity is tested at a current pulse duration of 25 ms and an accuracy of $\pm 11 \%$.

The above type numbers represent the order groups which include only a few brightness groups. Only one group will be shipped on each reel (there will be no mixing of two groups on each reel). In order to ensure availability, single brightness groups will not be orderable.

In a similar manner for colors where wavelength groups are measured and binned, single wavelength groups will be shipped on any one reel.

In order to ensure availability, single wavelength groups will not be orderable.

COLOR CLASSIFICATION				
GROUP	YELLOW		SOFT ORANGE	
	DOM. WAVELENGTH (NM)			
	MIN.	MAX.	MIN.	MAX.
1	581	584		
2	583	586	600	603
3	585	588	602	605
4	587	590	604	607
5	589	592	606	609
6	591	594	608	611

Note:
Wavelengths are tested at a current pulse duration of 25 ms and an accuracy of ± 1 nm.

CROSSING TABLE	
VISHAY	OSRAM
TLMK32T2V1	LAE67BT2V1
TLMK32U2AA	LAE67BU2AA
TLMK32T2AA	LAE67BT2AA
TLMS32S2U1	LSE67AS2U1
TLMS32T1U2	LSE67AT1U2
TLMS32S2V1	LSE67AS2V1
TLMO32U2AA	LOE67BU2AA
TLMY32T2V1	LYE67BT2V1
TLMY32U2AA	LYE67BU2AA
TLMY32T2AA	LYE67BT2AA

TYPICAL CHARACTERISTICS

$T_{amb} = 25\text{ }^{\circ}\text{C}$, unless otherwise specified

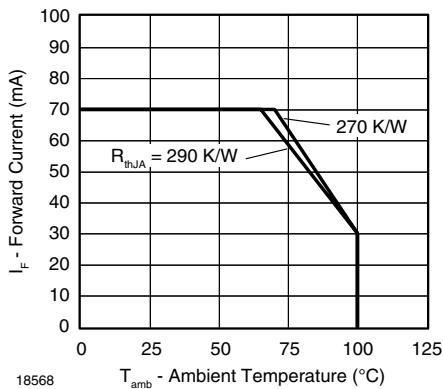

Figure 1. Forward Current vs. Ambient Temperature

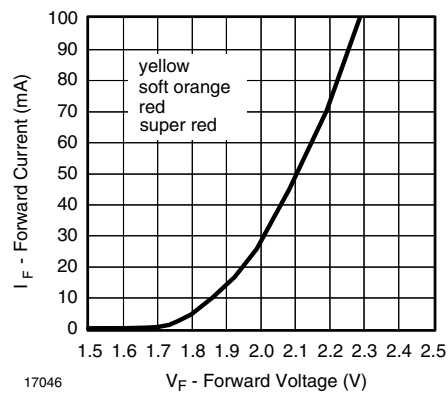

Figure 3. Forward Current vs. Forward Voltage

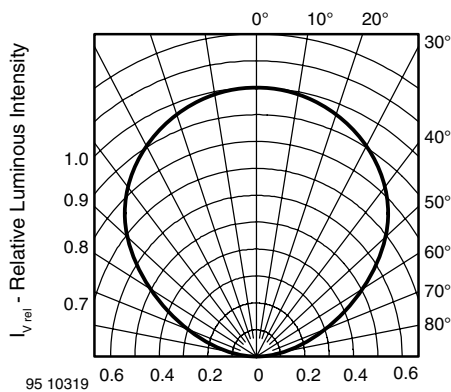

Figure 2. Rel. Luminous Intensity vs. Angular Displacement

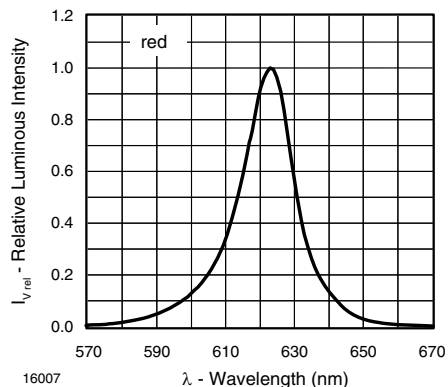

Figure 4. Relative Intensity vs. Wavelength

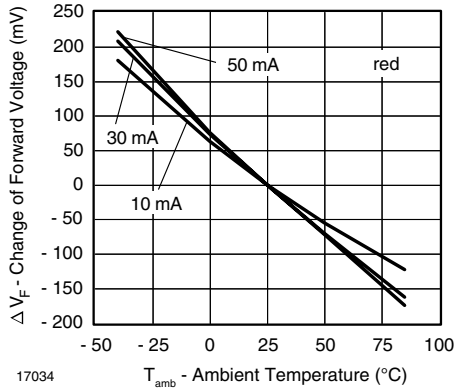

Figure 5. Change of Forward Voltage vs. Ambient Temperature

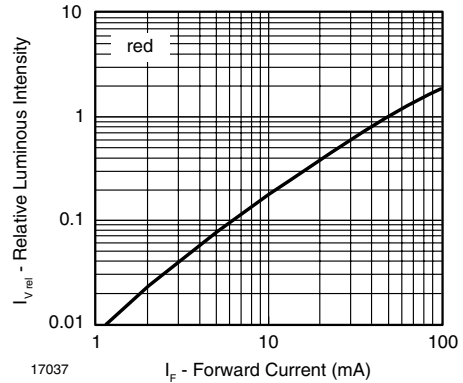

Figure 8. Relative Luminous Intensity vs. Forward Current

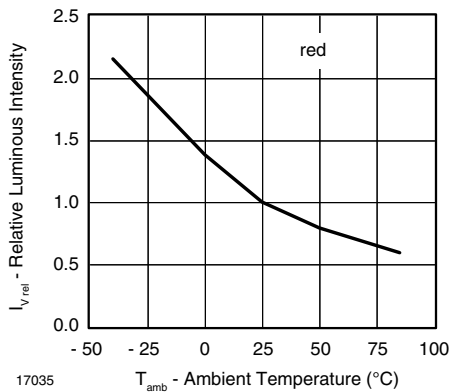

Figure 6. Relative Luminous Intensity vs. Ambient Temperature

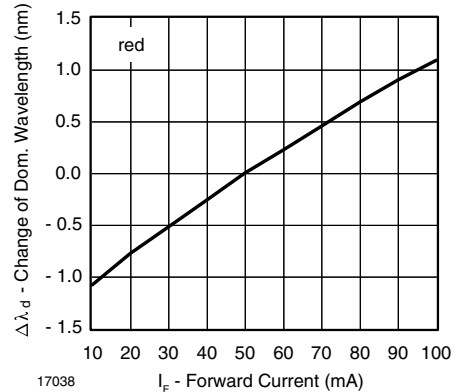

Figure 9. Change of Dominant Wavelength vs. Forward Current

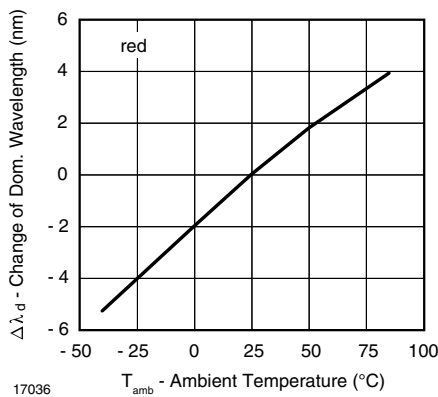

Figure 7. Change of Dominant Wavelength vs. Ambient Temperature

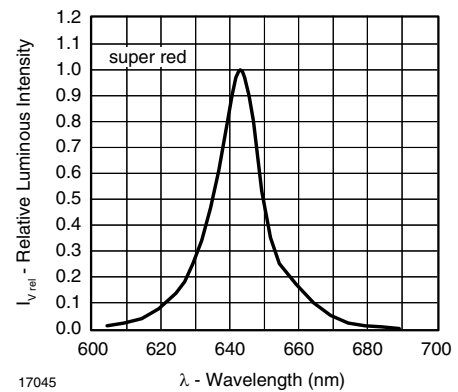

Figure 10. Relative Intensity vs. Wavelength

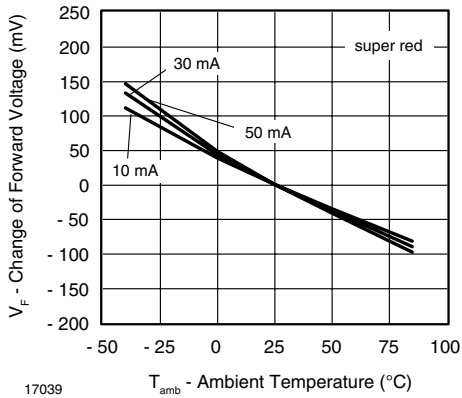

Figure 11. Change of Forward Voltage vs. Ambient Temperature

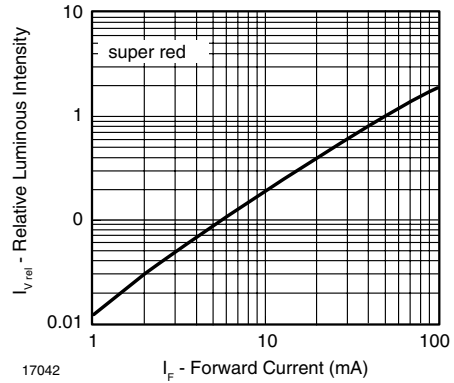

Figure 14. Relative Luminous Intensity vs. Forward Current

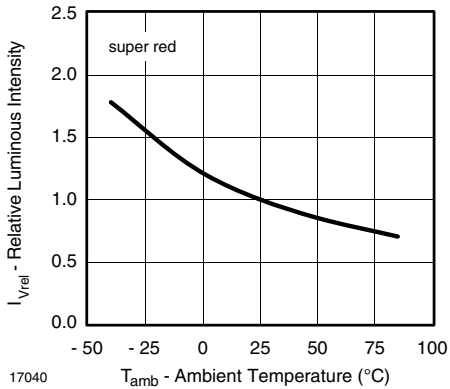

Figure 12. Relative Luminous Intensity vs. Ambient Temperature

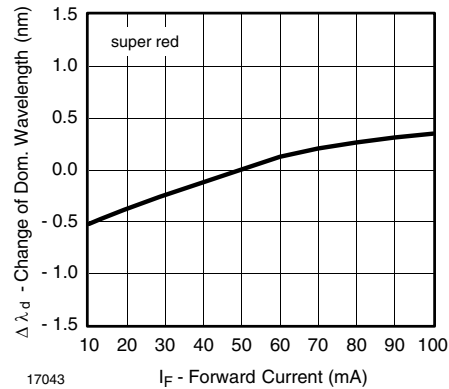

Figure 15. Change of Dominant Wavelength vs. Forward Current

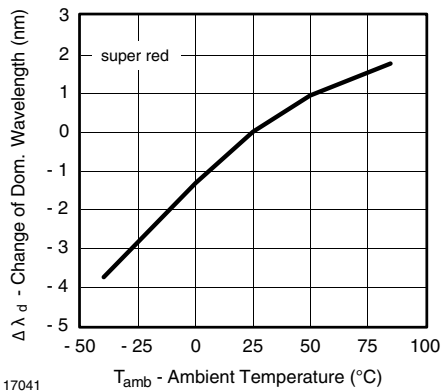

Figure 13. Change of Dominant Wavelength vs. Ambient Temperature

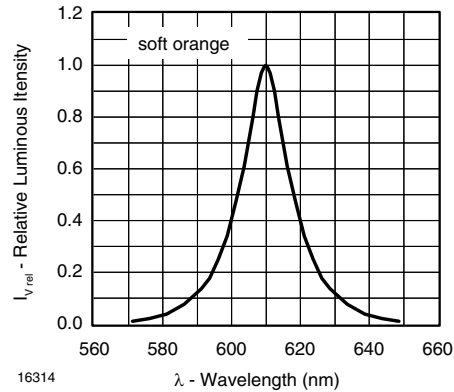

Figure 16. Relative Intensity vs. Wavelength

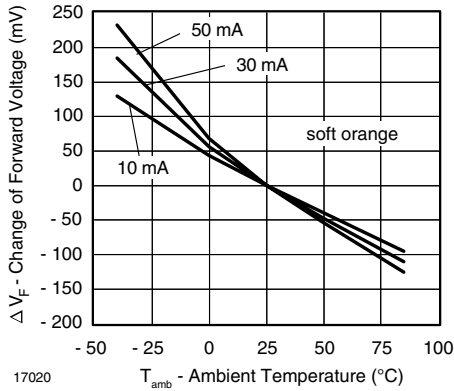

Figure 17. Change of Forward Voltage vs. Ambient Temperature

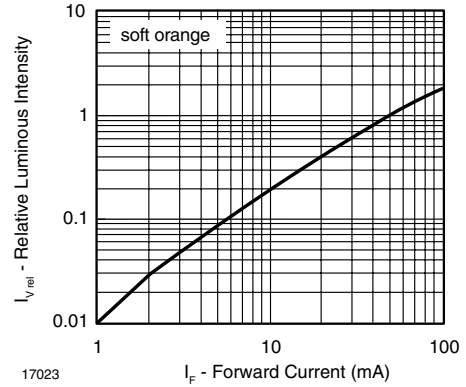

Figure 20. Relative Luminous Intensity vs. Forward Current

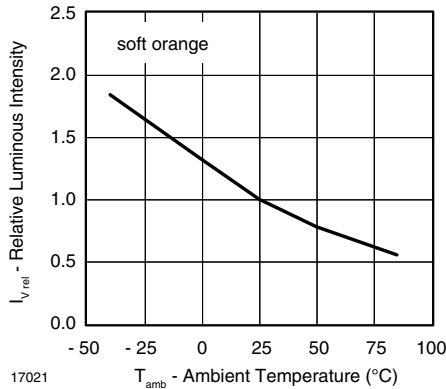

Figure 18. Relative Luminous Intensity vs. Ambient Temperature

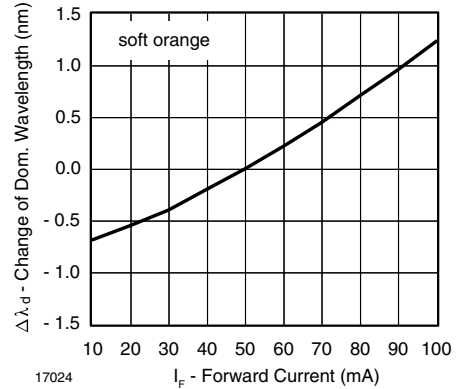

Figure 21. Change of Dominant Wavelength vs. Forward Current

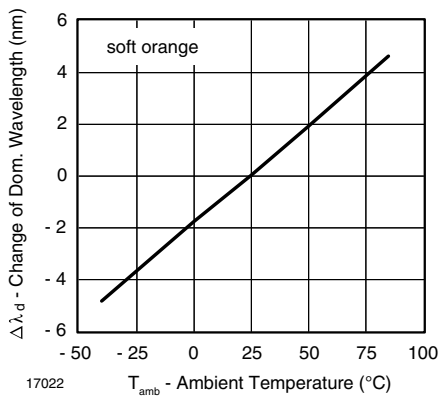

Figure 19. Change of Dominant Wavelength vs. Ambient Temperature

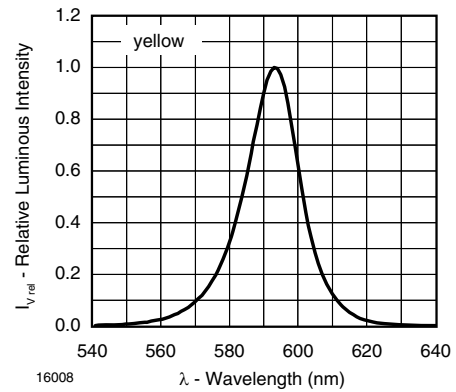

Figure 22. Relative Intensity vs. Wavelength

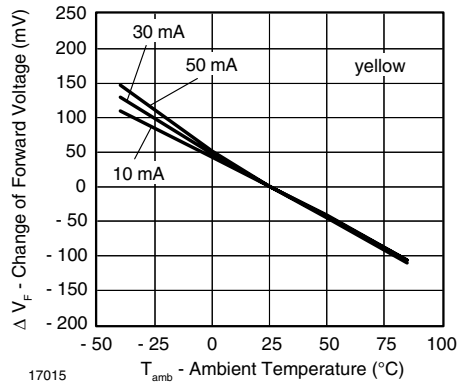

Figure 23. Change of Forward Voltage vs. Ambient Temperature

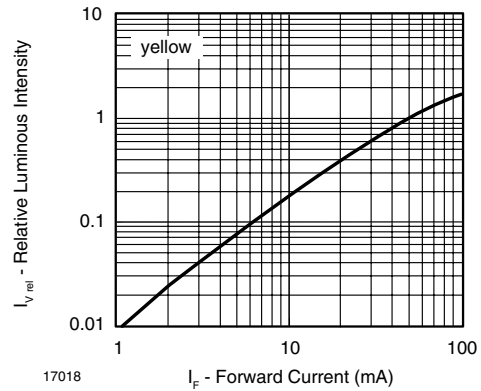

Figure 26. Relative Luminous Intensity vs. Forward Current

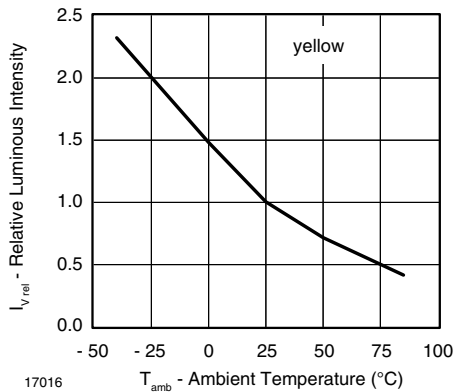

Figure 24. Relative Luminous Intensity vs. Ambient Temperature

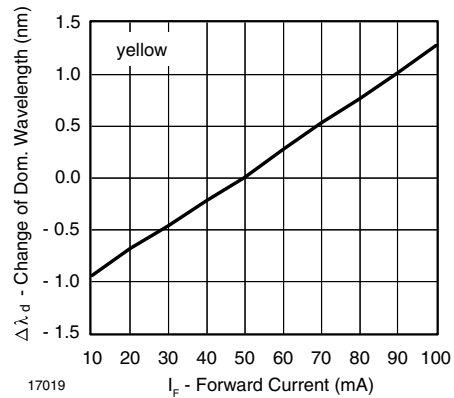

Figure 27. Change of Dominant Wavelength vs. Forward Current

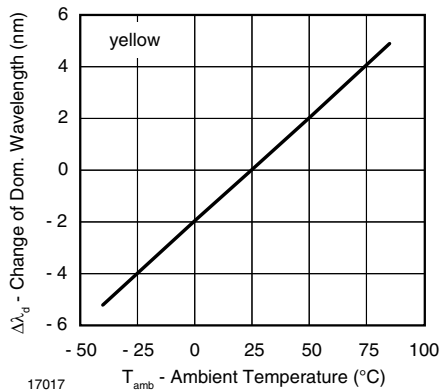

Figure 25. Change of Dominant Wavelength vs. Ambient Temperature

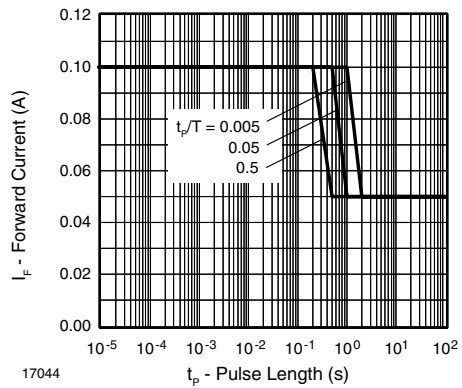
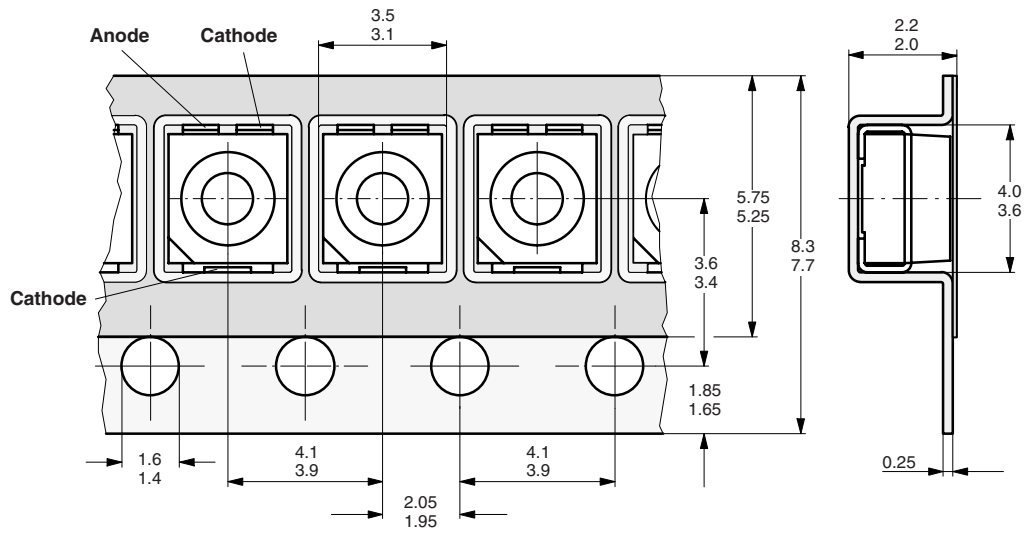
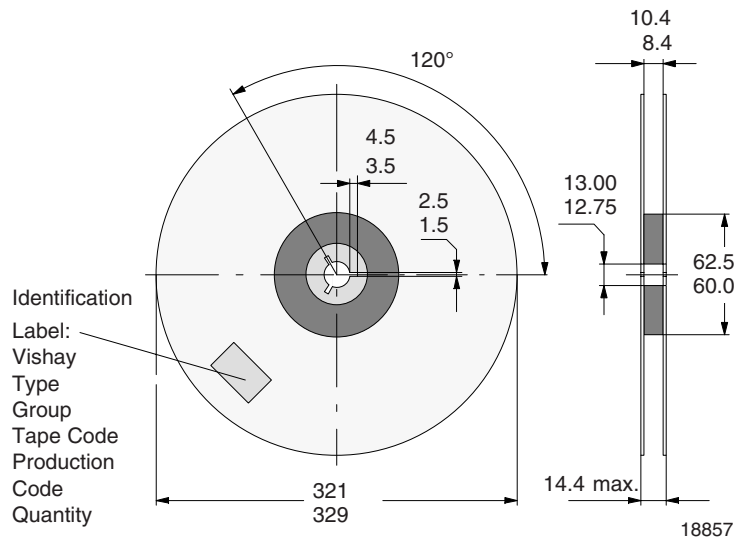

Figure 28. Forward Current vs. Pulse Length

TAPING DIMENSIONS in millimeters



REEL DIMENSIONS in millimeters



RECOMMENDED PAD DESIGN Dimensions in millimeters
 (Wave-Soldering), $R_{thJA} = 270 \text{ K/W}$

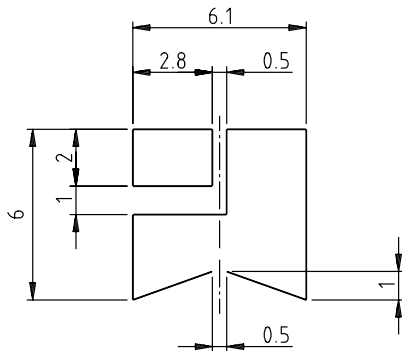

Pad design for improved head dissipation

solder resist

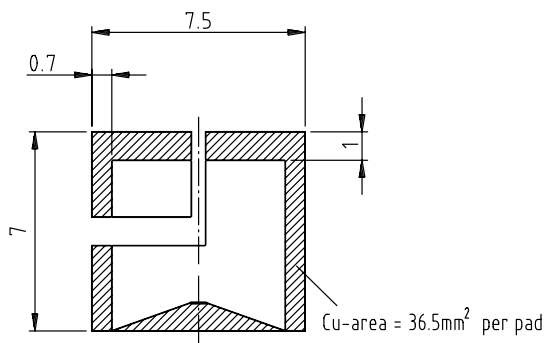

Component location on pad

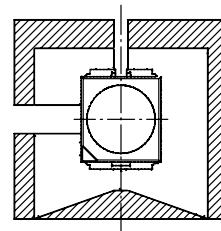

16260

RECOMMENDED PAD DESIGN Dimensions in millimeters
 (Reflow-Soldering), $R_{thJA} = 270 \text{ K/W}$

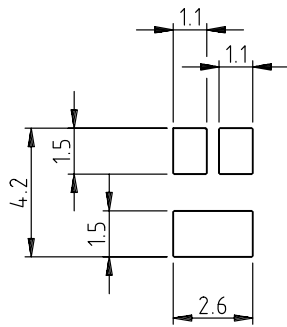

Pad design for improved head dissipation

solder resist

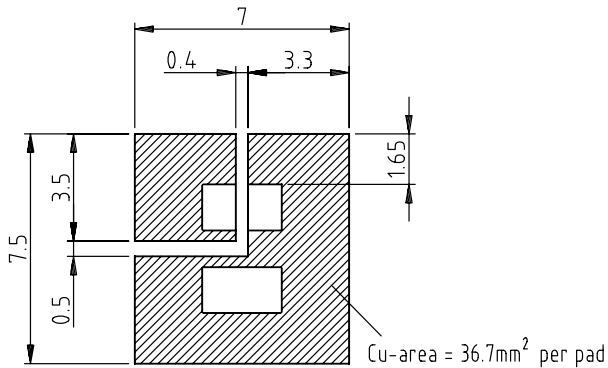

Component location on pad

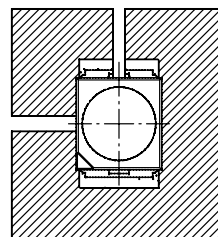

16261

OPTIONAL PAD DESIGN Dimensions in millimeters
 (Wave-Soldering), $R_{thJA} = 290 \text{ K/W}$

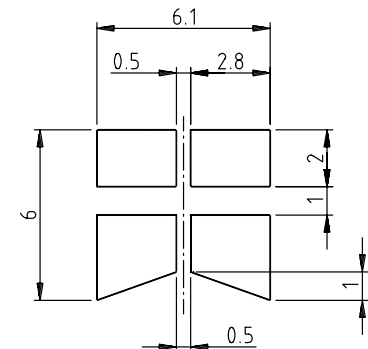

Optional paddesign

solder resist

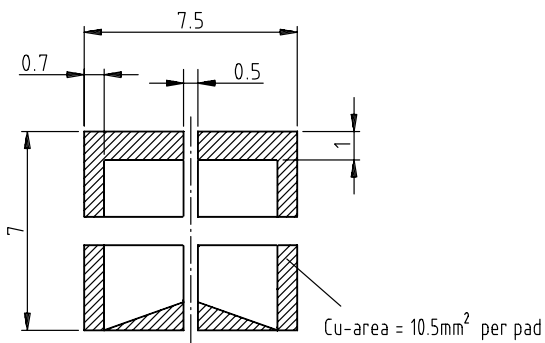

Component location on pad

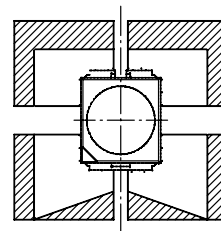

16262

OPTIONAL PAD DESIGN Dimensions in millimeters
 (Reflow-Soldering), $R_{thJA} = 290 \text{ K/W}$

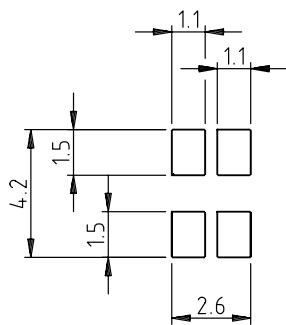

Optional paddesign

solder resist

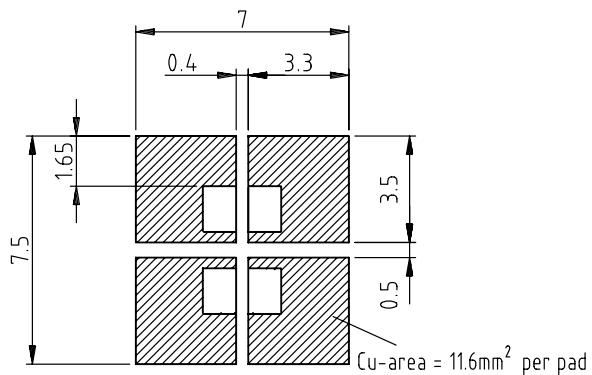

Component location on pad

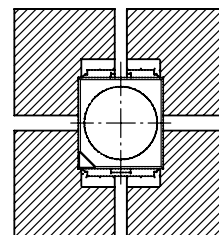

16263

PACKAGE DIMENSIONS in millimeters

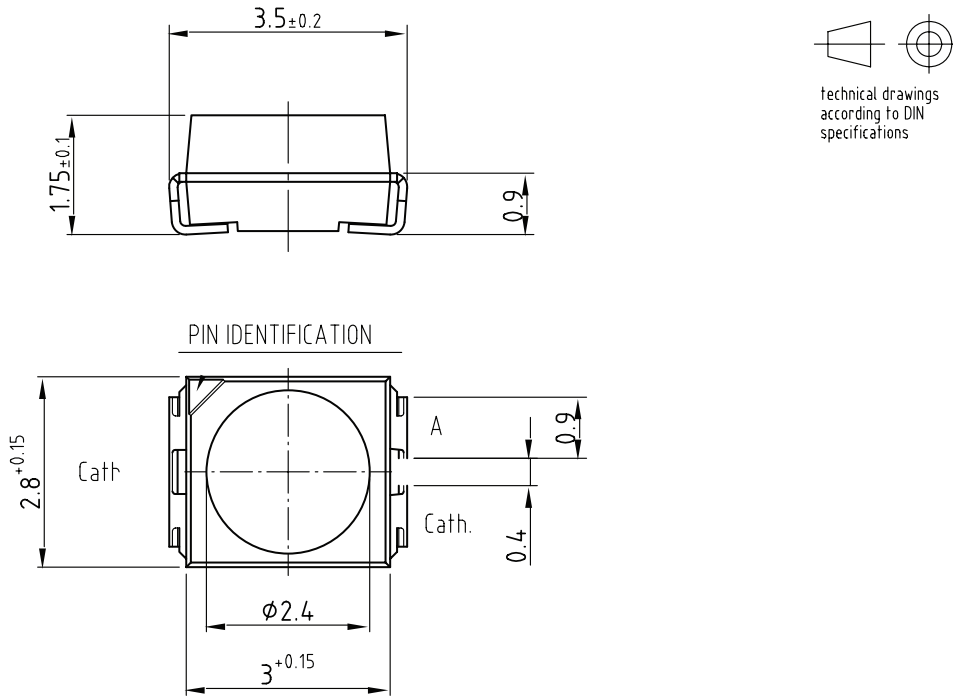

Drawing-No. : 6.541-5054.01-4
 Issue: 2; 02.12.05
 16276_2

SOLDERING PROFILE

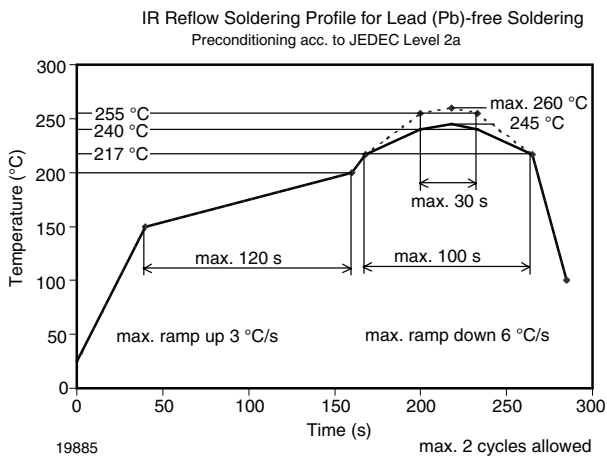

Figure 29. Vishay Lead (Pb)-free Reflow Soldering Profile (acc. to J-STD-020B)

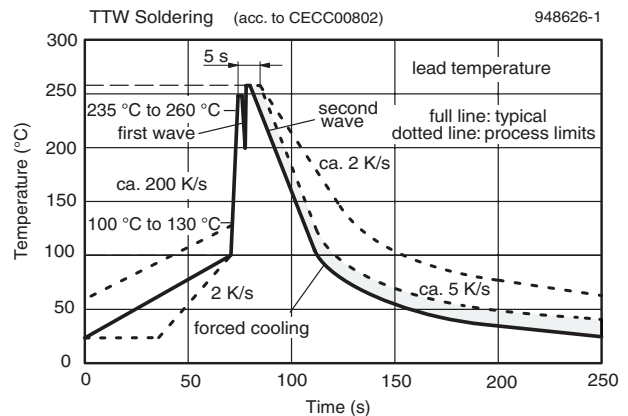
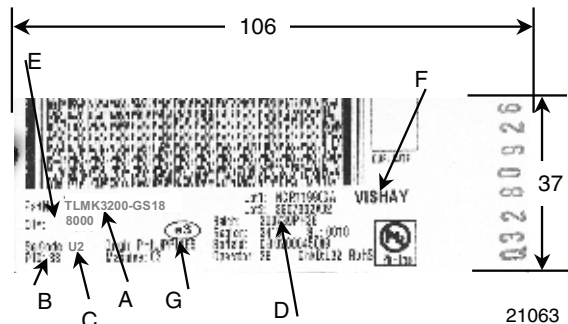

Figure 30. Double Wave Soldering of Opto Devices (all Packages)

**LABEL OF FAN FOLD BOX
EXAMPLE:**

- A) Type of component
- B) PTC = manufacturing plant
- C) SEL - selection code (bin):
e.g.: U2 = code for luminous intensity group
- D) Batch/date code
- E) Total quantity
- F) Company code
- G) Code for lead (Pb)-free classification (e3)

DRY PACKING

The reel is packed in an anti-humidity bag to protect the devices from absorbing moisture during transportation and storage.

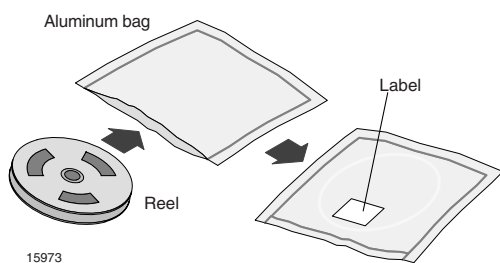
FINAL PACKING

The sealed reel is packed into a cardboard box. A secondary cardboard box is used for shipping purposes.

RECOMMENDED METHOD OF STORAGE

Dry box storage is recommended as soon as the aluminum bag has been opened to prevent moisture absorption. The following conditions should be observed, if dry boxes are not available:

- Storage temperature 10 °C to 30 °C
- Storage humidity ≤ 60 % RH max.

After more than 672 h under these conditions moisture content will be too high for reflow soldering.

In case of moisture absorption, the devices will recover to the former condition by drying under the following condition:

192 h at 40 °C + 5 °C/- 0 °C and < 5 % RH (dry air/nitrogen) or

96 h at 60 °C + 5 °C and < 5 % RH for all device containers or

24 h at 100 °C + 5 °C not suitable for reel or tubes.

An EIA JEDEC standard JESD22-A112 level 2a label is included on all dry bags.

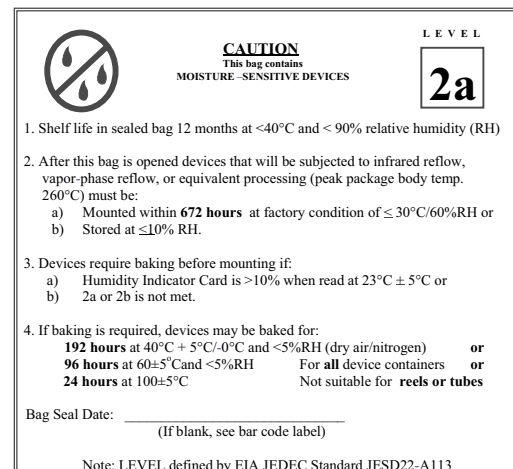

Example of JESD22-A112 level 2a label

ESD PRECAUTION

Proper storage and handling procedures should be followed to prevent ESD damage to the devices especially when they are removed from the antistatic shielding bag. Electro-static sensitive devices warning labels are on the packaging.

**VISHAY SEMICONDUCTORS STANDARD
BAR CODE LABELS**

The Vishay Semiconductors standard bar code labels are printed at final packing areas. The labels are on each packing unit and contain Vishay Semiconductors specific data.

OZONE DEPLETING SUBSTANCES POLICY STATEMENT

It is the policy of Vishay Semiconductor GmbH to

1. Meet all present and future national and international statutory requirements.
2. Regularly and continuously improve the performance of our products, processes, distribution and operating systems with respect to their impact on the health and safety of our employees and the public, as well as their impact on the environment.

It is particular concern to control or eliminate releases of those substances into the atmosphere which are known as ozone depleting substances (ODSs).

The Montreal Protocol (1987) and its London Amendments (1990) intend to severely restrict the use of ODSs and forbid their use within the next ten years. Various national and international initiatives are pressing for an earlier ban on these substances.

Vishay Semiconductor GmbH has been able to use its policy of continuous improvements to eliminate the use of ODSs listed in the following documents.

1. Annex A, B and list of transitional substances of the Montreal Protocol and the London Amendments respectively.
2. Class I and II ozone depleting substances in the Clean Air Act Amendments of 1990 by the Environmental Protection Agency (EPA) in the USA.
3. Council Decision 88/540/EEC and 91/690/EEC Annex A, B and C (transitional substances) respectively.

Vishay Semiconductor GmbH can certify that our semiconductors are not manufactured with ozone depleting substances and do not contain such substances.

We reserve the right to make changes to improve technical design
and may do so without further notice.

Parameters can vary in different applications. All operating parameters must be validated for each customer application by the customer. Should the buyer use Vishay Semiconductors products for any unintended or unauthorized application, the buyer shall indemnify Vishay Semiconductors against all claims, costs, damages, and expenses, arising out of, directly or indirectly, any claim of personal damage, injury or death associated with such unintended or unauthorized use.

Vishay Semiconductor GmbH, P.O.B. 3535, D-74025 Heilbronn, Germany



Disclaimer

All product specifications and data are subject to change without notice.

Vishay Intertechnology, Inc., its affiliates, agents, and employees, and all persons acting on its or their behalf (collectively, "Vishay"), disclaim any and all liability for any errors, inaccuracies or incompleteness contained herein or in any other disclosure relating to any product.

Vishay disclaims any and all liability arising out of the use or application of any product described herein or of any information provided herein to the maximum extent permitted by law. The product specifications do not expand or otherwise modify Vishay's terms and conditions of purchase, including but not limited to the warranty expressed therein, which apply to these products.

No license, express or implied, by estoppel or otherwise, to any intellectual property rights is granted by this document or by any conduct of Vishay.

The products shown herein are not designed for use in medical, life-saving, or life-sustaining applications unless otherwise expressly indicated. Customers using or selling Vishay products not expressly indicated for use in such applications do so entirely at their own risk and agree to fully indemnify Vishay for any damages arising or resulting from such use or sale. Please contact authorized Vishay personnel to obtain written terms and conditions regarding products designed for such applications.

Product names and markings noted herein may be trademarks of their respective owners.