

0.4 mm Pitch, 0.98 mm Mated Height, Board-to-Board / Board-to-FPC Connectors

DF37 Series

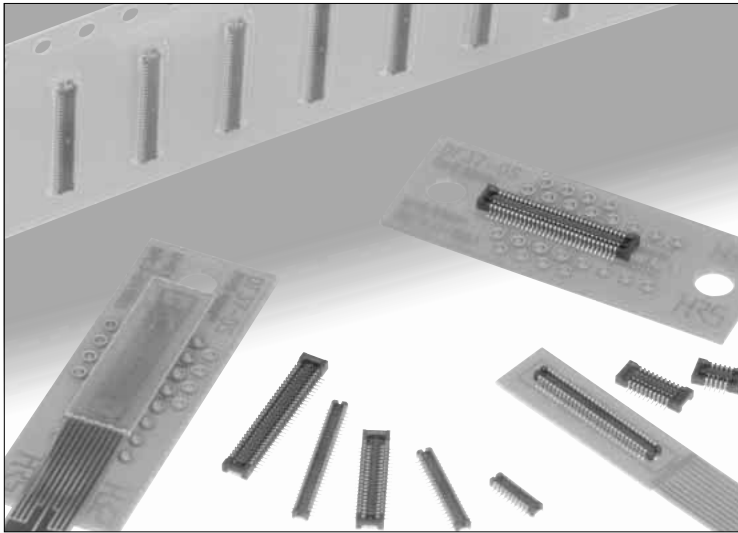

Further reduction of the board space.

Comparison of board mounting space

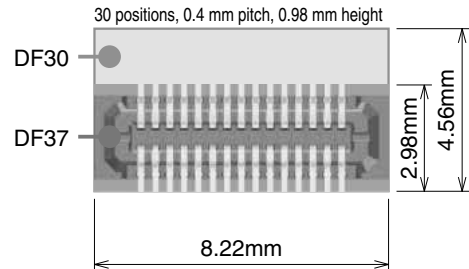

Features

1. Reduced size and board-occupied area

With the mated height of 0.98 mm, width of 2.98mm and length of 8.22 mm (30 positions) the connectors are one of the smallest in its class.

Sufficiently large flat areas allow pick-up with vacuum nozzles of automatic placement equipment.

2. Reliable electrical and mechanical connection

Despite its small mated height, unique contact configuration, with a 2-point contacts and effective mating length of 0.25mm, assures highly reliable connection while confirming a complete mating with a definite tactile feel.

3. Self alignment

Recognizing the difficulties of mating extremely small connectors in limited spaces, the connectors will self-align within 0.3mm.

4. Physical shock and vibration protection

2-point contact assures electrical connection in a shock or vibration applications.

5. Solder wicking prevention

Nickel barriers (receptacles) and unique forming of the contacts (headers) prevent un-intentional solder wicking.

6. Contamination protection

Insulator walls protect the contact areas against flux splatter or other physical particles contamination.

7. RoHS compliant

All components and materials comply with the requirements of EU Directive 2002/95/EC.

Applications

Mobile phones, digital cameras, digital camcorders and other thin portable devices requiring high reliability board-to-board/ board-to-FPC connections.

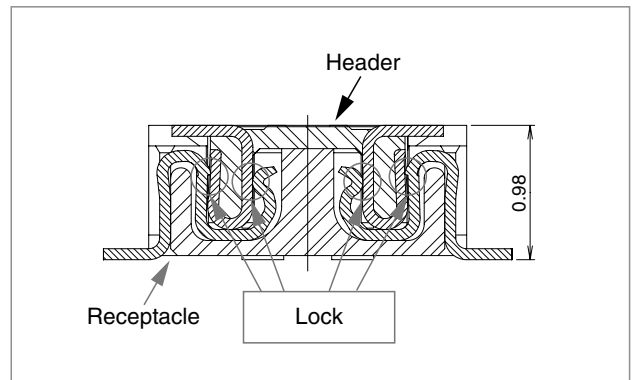

Splatter protection

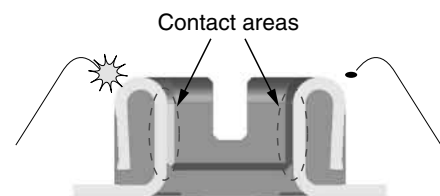

Contact areas are not exposed to the outside penetration of the flux or other physical particles.

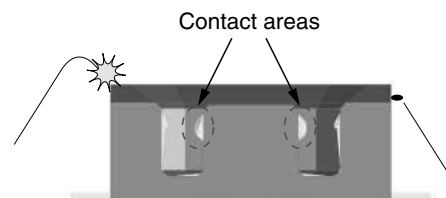

■ Specifications

Ratings	Current rating	0.3 A	Operating temperature range	-35°C to +85°C (Note 1)	Storage temperature range	-10°C to +60°C (Note 2)
	Voltage rating	30 V AC, DC	Operating humidity range	RH 20% to 80%	Storage humidity range	RH 40% to 70% (Note 2)

Item	Specification	Conditions
1. Insulation resistance	50 MΩ min	100 V DC
2. Withstanding voltage	No flashover or insulation breakdown	100 V AC / 1 minute
3. Contact resistance	100 mΩ max.	20 mV AC, 1 kHz, 1 mA
4. Vibration	No electrical discontinuity of 1 μs or longer No damage or parts dislocation	Frequency: 10 to 55 Hz, single amplitude of 0.75 mm, 2 hours, 3 axis
5. Humidity	Contact resistance: 100 mΩ max., Insulation resistance: 25 MΩ min.	96 hours at 40 ±2°C and humidity of 90 to 95% No damage or parts dislocation
6. Temperature cycle	Contact resistance: 100 mΩ max., Insulation resistance: 50 MΩ min. No damage or parts dislocation	-55°C → 5 to 35°C → 85°C → 5 to 35°C Time: 30 min. → 10 min. → 30 min. → 10 min. 5 cycles
7. Durability	Contact resistance: 100 mΩ max.	10 cycles
8. Resistance to soldering heat	No deformation of components affecting performance	Reflow: At the recommended temperature profile Manual soldering: 350°C for 3 seconds

Note 1: Includes temperature rise caused by current flow.

Note 2: The term "storage" here refers to products stored for a long period prior to board mounting and use.

The operating temperature and humidity range covers the non-conducting condition of connectors after board mounting and the temporary storage conditions of transportation, etc.

■ Materials

Receptacle

Part	Material	Finish	Remarks
Insulator	LCP	Color: Black	UL94V-0

Header

Part	Material	Finish	Remarks
Contacts	Phosphor bronze	Gold plated	—————

■ Ordering Information

● Receptacles

DF 37 N # - * DS - 0.4 V ()**

① ② ③ ④ ⑤ ⑥ ⑦

① Series name : DF37N	④ Connector style DS: Receptacle
② Configuration B: With metal fittings C: Without metal fittings	⑤ Contact pitch : 0.4 mm
	⑥ Terminal type V: SMT vertical mount
③ Number of contacts 10, 16, 20, 24, 30, 34, 40, 50, 60, 70, 74	⑦ Packaging (51): Embossed tape packaging (8,000 pieces per reel) (53): Embossed tape packaging (1,000 pieces per reel)

● Headers

DF 37 # - * DP - 0.4 V ()**

① ② ③ ④ ⑤ ⑥ ⑦

① Series name : DF37	④ Connector style DP: Header
② Configuration B: With metal fittings C: Without metal fittings	⑤ Contact pitch : 0.4 mm
	⑥ Terminal type V: SMT vertical mount
③ Number of contacts 10, 16, 20, 24, 30, 34, 40, 50, 60, 70, 74	⑦ Packaging (51): Embossed tape packaging (8,000 pieces per reel) (53): Embossed tape packaging (1,000 pieces per reel)

■ Receptacles

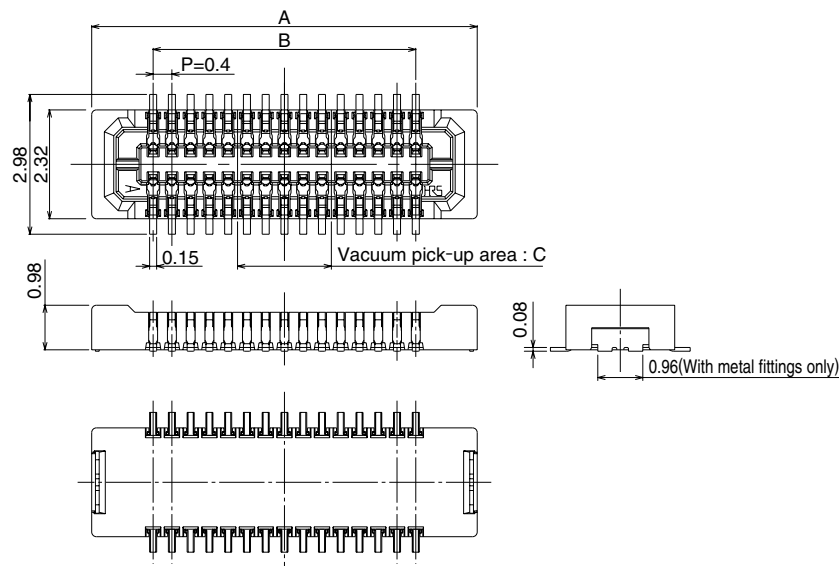
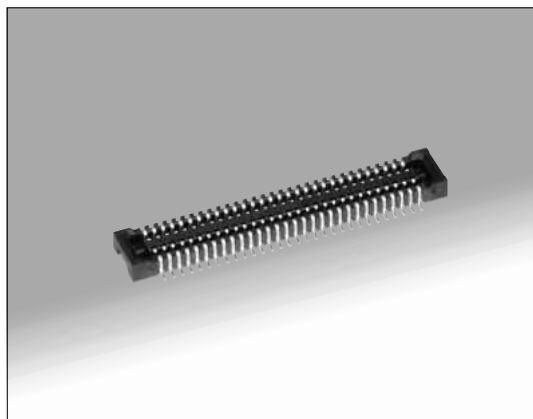

◆ Recommended metal mask dimensions

With metal fittings

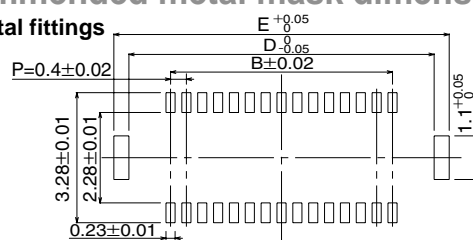

Without metal fittings

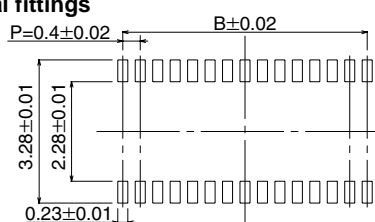

◆ Recommended PCB mounting pattern

With metal fittings

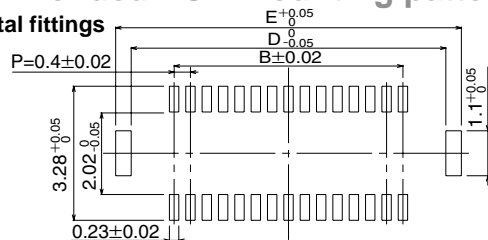

Without metal fittings

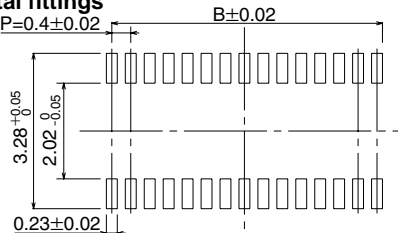

● With metal fittings

All dimensions: mm

Part Number	CL No.	Number of Contacts	A	B	C	D	E	RoHS
DF37NB-10DS-0.4V(51)	CL684-3301-6-51	10	4.22	1.6	0.8	3.7	4.46	YES
DF37NB-16DS-0.4V(51)	CL684-3302-9-51	16	5.42	2.8	1.2	4.9	5.66	
DF37NB-20DS-0.4V(51)	CL684-3303-1-51	20	6.22	3.6	1.6	5.7	6.46	
DF37NB-24DS-0.4V(51)	CL684-3304-4-51	24	7.02	4.4	2	6.5	7.26	
DF37NB-30DS-0.4V(51)	CL684-3305-7-51	30	8.22	5.6	2	7.7	8.46	
DF37NB-34DS-0.4V(51)	CL684-3082-4-51	34	9.02	6.4	2.4	8.5	9.26	
DF37NB-40DS-0.4V(51)	CL684-3306-0-51	40	10.22	7.6	2.4	9.7	10.46	
DF37NB-50DS-0.4V(51)	CL684-3307-2-51	50	12.22	9.6	2.8	11.7	12.46	
DF37NB-60DS-0.4V(51)	CL684-3308-5-51	60	14.22	11.6	3.2	13.7	14.46	
DF37NB-70DS-0.4V(51)	CL684-3409-2-51	70	16.22	13.6	3.6	15.7	16.46	
DF37NB-74DS-0.4V(51)	CL684-3080-9-51	74	17.02	14.4	4	16.5	17.26	

● Without metal fittings

All dimensions: mm

Part Number	CL No.	Number of Contacts	A	B	C	RoHS
DF37NC-10DS-0.4V(51)	CL684-3309-8-51	10	4.22	1.6	0.8	YES
DF37NC-16DS-0.4V(51)	CL684-3310-7-51	16	5.42	2.8	1.2	
DF37NC-20DS-0.4V(51)	CL684-3311-0-51	20	6.22	3.6	1.6	
DF37NC-24DS-0.4V(51)	CL684-3312-2-51	24	7.02	4.4	2	
DF37NC-30DS-0.4V(51)	CL684-3313-5-51	30	8.22	5.6	2	
DF37NC-34DS-0.4V(51)	CL684-3083-7-51	34	9.02	6.4	2.4	
DF37NC-40DS-0.4V(51)	CL684-3314-8-51	40	10.22	7.6	2.4	
DF37NC-50DS-0.4V(51)	CL684-3315-0-51	50	12.22	9.6	2.8	
DF37NC-60DS-0.4V(51)	CL684-3316-3-51	60	14.22	11.6	3.2	
DF37NC-70DS-0.4V(51)	CL684-3084-0-51	70	16.22	13.6	3.6	
DF37NC-74DS-0.4V(51)	CL684-3081-1-51	74	17.02	14.4	4	

Note 1: Tape and reel packaging (8,000 pieces/reel).
 Order by number of reels.

Note 2: This connector is NOT polarized.

■ Headers

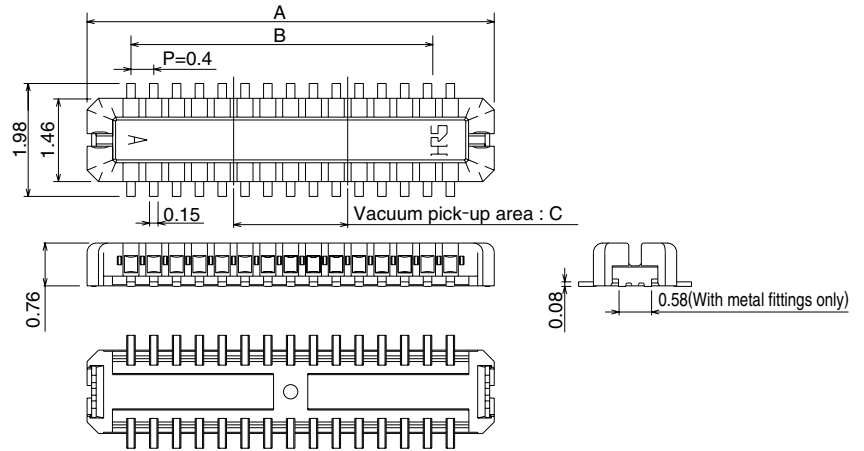
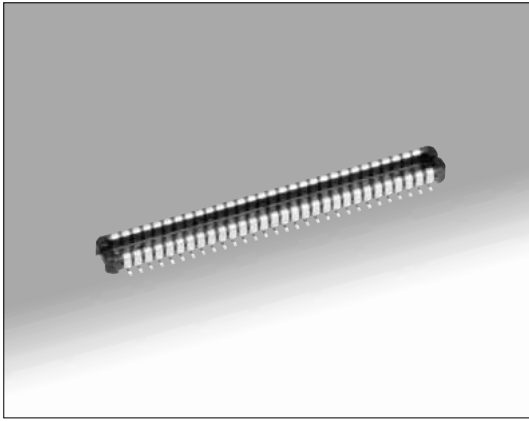

◆ Recommended metal mask dimensions

With metal fittings

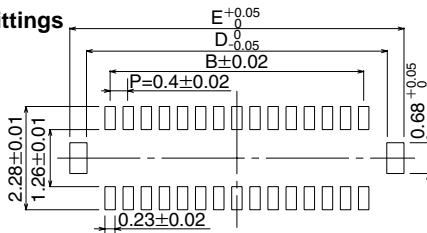

Without metal fittings

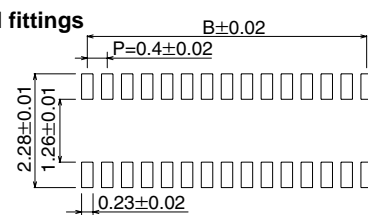

◆ Recommended PCB mounting pattern

With metal fittings

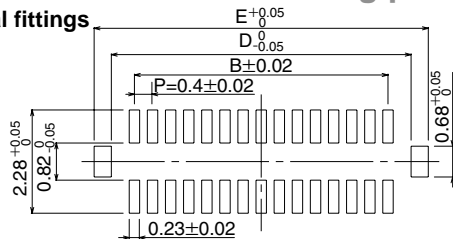

Without metal fittings

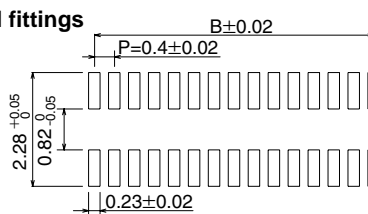

● With metal fittings

All dimensions: mm

Part Number	CL No.	Number of Contacts	A	B	C	D	E	RoHS
DF37B-10DP-0.4V(51)	CL684-3037-0-51	10	3.14	1.6	0.8	2.62	3.38	YES
DF37B-16DP-0.4V(51)	CL684-3057-7-51	16	4.34	2.8	1.2	3.82	4.58	
DF37B-20DP-0.4V(51)	CL684-3008-1-51	20	5.17	3.6	1.6	4.62	5.38	
DF37B-24DP-0.4V(51)	CL684-3009-4-51	24	5.94	4.4	2	5.42	6.18	
DF37B-30DP-0.4V(51)	CL684-3010-3-51	30	7.14	5.6	2	6.62	7.38	
DF37B-34DP-0.4V(51)	CL684-3064-2-51	34	7.94	6.4	2.4	7.42	8.18	
DF37B-40DP-0.4V(51)	CL684-3011-6-51	40	9.14	7.6	2.4	8.62	9.38	
DF37B-50DP-0.4V(51)	CL684-3012-9-51	50	11.14	9.6	2.8	10.62	11.38	
DF37B-60DP-0.4V(51)	CL684-3013-1-51	60	13.14	11.6	3.2	12.62	13.38	
DF37B-70DP-0.4V(51)	CL684-3014-4-51	70	15.14	13.6	3.6	14.62	15.38	
DF37B-74DP-0.4V(51)	CL684-3071-8-51	74	15.94	14.4	4	15.42	16.18	

● Without metal fittings

All dimensions: mm

Part Number	CL No.	Number of Contacts	A	B	C	RoHS
DF37C-10DP-0.4V(51)	CL684-3039-5-51	10	3.14	1.6	0.8	YES
DF37C-16DP-0.4V(51)	CL684-3058-0-51	16	4.34	2.8	1.2	
DF37C-20DP-0.4V(51)	CL684-3024-8-51	20	5.17	3.6	1.6	
DF37C-24DP-0.4V(51)	CL684-3025-0-51	24	5.94	4.4	2	
DF37C-30DP-0.4V(51)	CL684-3026-3-51	30	7.14	5.6	2	
DF37C-34DP-0.4V(51)	CL684-3085-2-51	34	7.94	6.4	2.4	
DF37C-40DP-0.4V(51)	CL684-3027-6-51	40	9.14	7.6	2.4	
DF37C-50DP-0.4V(51)	CL684-3028-9-51	50	11.14	9.6	2.8	
DF37C-60DP-0.4V(51)	CL684-3029-1-51	60	13.14	11.6	3.2	
DF37C-70DP-0.4V(51)	CL684-3030-0-51	70	15.14	13.6	3.6	
DF37C-74DP-0.4V(51)	CL684-3073-3-51	74	15.94	14.4	4	

Note 1: Tape and reel packaging (8,000 pieces/reel).

Order by number of reels.

Note 2: This connector is NOT polarized.

■ Packaging Specifications

◆ Embossed Carrier Tape Dimensions

● Receptacle (20 and above positions)

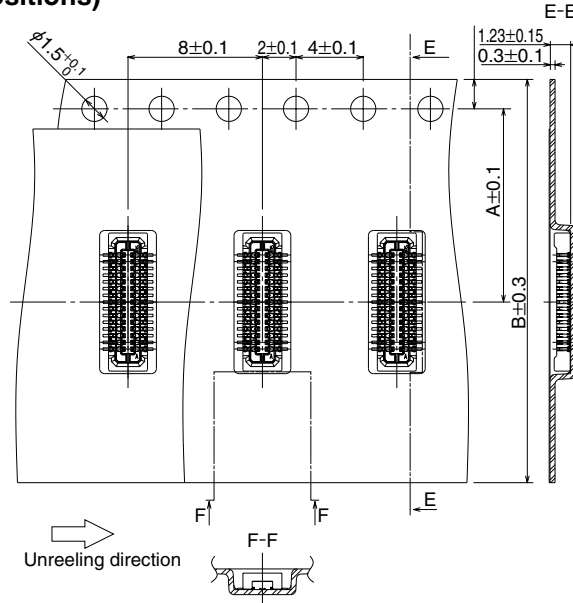

● Receptacle (less than 20 positions)

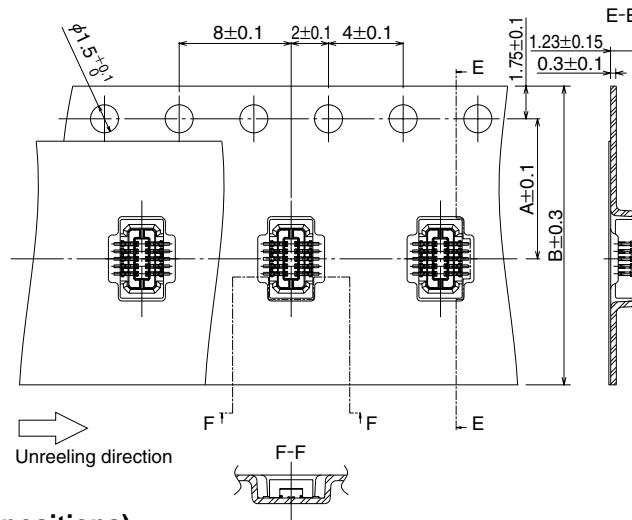

● Receptacle (more than 60 positions)

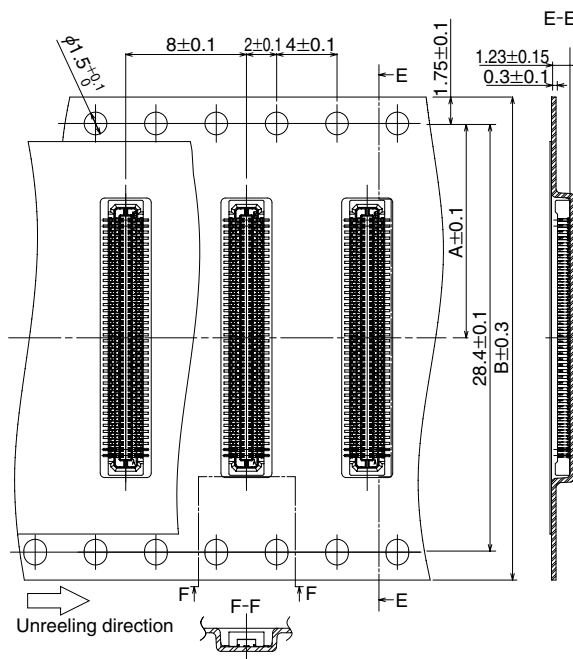

● Reel Dimensions

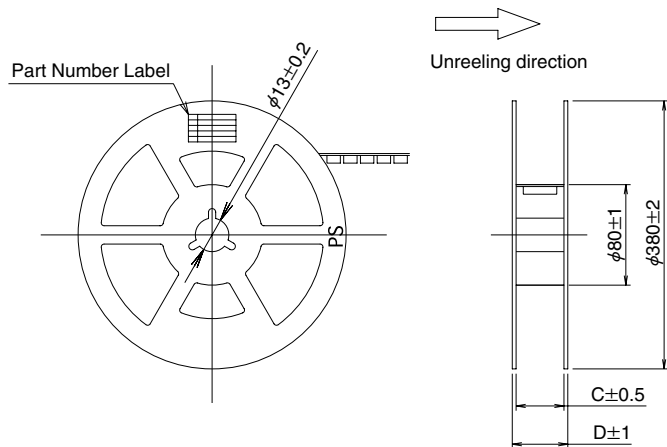

All dimensions: mm

Part Number	A	B	C	D
DF37N#-10DS-0.4V(51)	7.5	16	17.5	21.5
DF37N#-16DS-0.4V(51)	7.5	16	17.5	21.5
DF37N#-20DS-0.4V(51)	7.5	16	17.5	21.5
DF37N#-24DS-0.4V(51)	7.5	16	17.5	21.5
DF37N#-30DS-0.4V(51)	11.5	24	25.5	29.5
DF37N#-34DS-0.4V(51)	11.5	24	25.5	29.5
DF37N#-40DS-0.4V(51)	11.5	24	25.5	29.5
DF37N#-50DS-0.4V(51)	11.5	24	25.5	29.5
DF37N#-60DS-0.4V(51)	11.5	24	25.5	29.5
DF37N#-70DS-0.4V(51)	14.2	32	33.5	37.5
DF37N#-74DS-0.4V(51)	14.2	32	33.5	37.5

#: B or C

Tape and reel packaging (8,000 pieces/reel).

◆ Embossed Carrier Tape Dimensions

● Header (less than 74 positions)

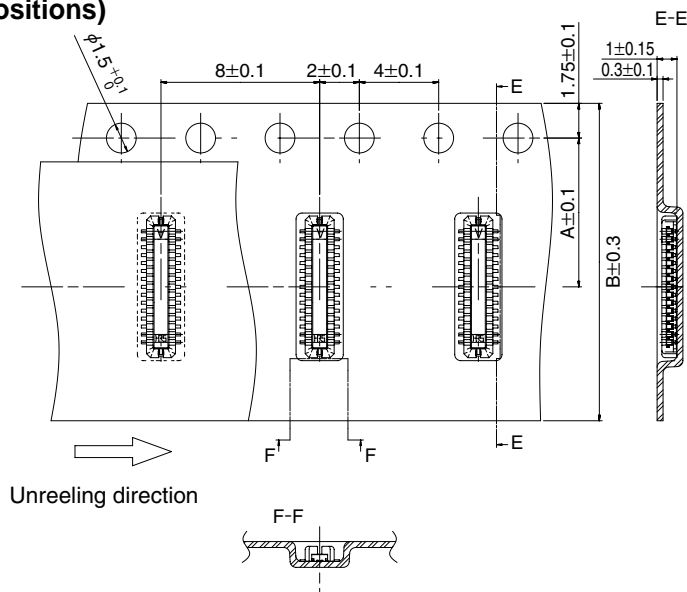

● Header (74 positions and above)

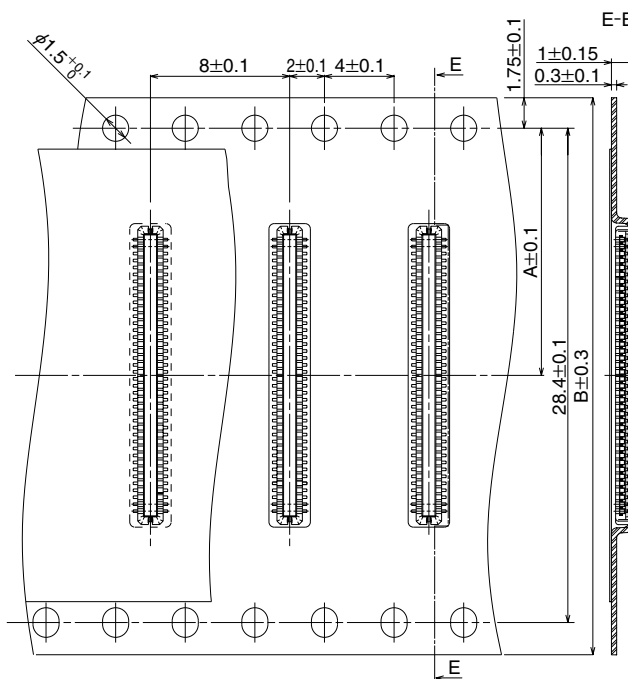

● Reel Dimensions

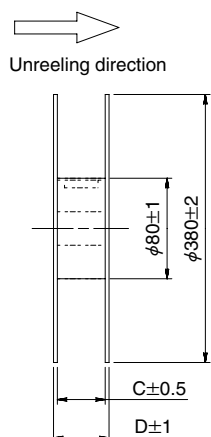
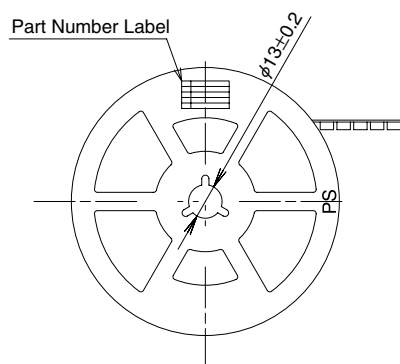

All dimensions: mm

Part Number	A	B	C	D
DF37#-10DP-0.4V(51)	5.5	12	13.5	17.5
DF37#-16DP-0.4V(51)	7.5	16	17.5	21.5
DF37#-20DP-0.4V(51)	7.5	16	17.5	21.5
DF37#-24DP-0.4V(51)	7.5	16	17.5	21.5
DF37#-30DP-0.4V(51)	11.5	24	25.5	29.5
DF37#-34DP-0.4V(51)	11.5	24	25.5	29.5
DF37#-40DP-0.4V(51)	11.5	24	25.5	29.5
DF37#-50DP-0.4V(51)	11.5	24	25.5	29.5
DF37#-60DP-0.4V(51)	11.5	24	25.5	29.5
DF37#-70DP-0.4V(51)	11.5	24	25.5	29.5
DF37#-74DP-0.4V(51)	14.2	32	33.5	37.5

#: B or C

Tape and reel packaging (8,000 pieces/reel).

◆ Usage Recommendations

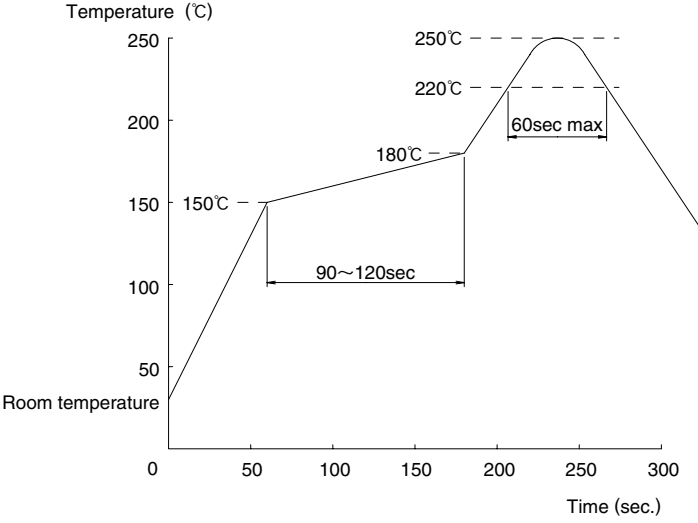
<p>1.Recommended temperature profile</p>	 <p>Note 1: Up to 2 cycles of Reflow soldering are possible under the same conditions, provided that there is a return to normal temperature between the first and second cycle.</p> <p>Note 2: The temperature profile indicates the board surface temperature at the point of contacts with the connector terminals.</p>
<p>2.Recommended manual soldering</p>	<p>Manual soldering: $340 \pm 10^{\circ}\text{C}$ for 3 seconds</p>
<p>3.Recommended screen thickness and open area ratio (Pattern area ratio)</p>	<p>Thickness: 0.12 mm Open area ratio: Receptacle:80%, Plug: 70%</p>
<p>4.Board warpage</p>	<p>Maximum of 0.02 mm at the connector center, with both ends of the connector as reference points.</p>
<p>5.Cleaning conditions</p>	<p>Cleaning is not recommended. When cleaning, please evaluate as it can deteriorate the performance including mechanical operation and environmental resistance.</p>
<p>6.Precautions</p>	<ul style="list-style-type: none"> ■ Mating and un-mating of the connectors when not soldered on the boards is not recommended as this may cause deformation of the terminals, damage to the contacts or insulators. ■ Mated connectors should not carry weight of the board by themselves. Provide some other support of the boards. ■ When mating/un-mating do not twist or lift by the corners. Apply the forces evenly across the entire length and width of the connectors taking care NOT to damage or deform soldered terminations. ■ Exercise extreme caution when mating/ un-mating when the connector is mounted on a nonrigid (flexible) substrate. Slight discoloration on the insulating materials will not affect form, fit or function of the connectors. ■ Do NOT pull on the flexible substrate.

◆ Handling Precautions when Mating Connectors

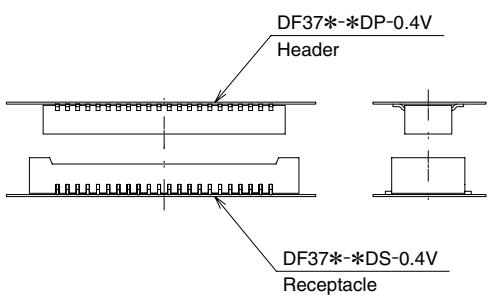
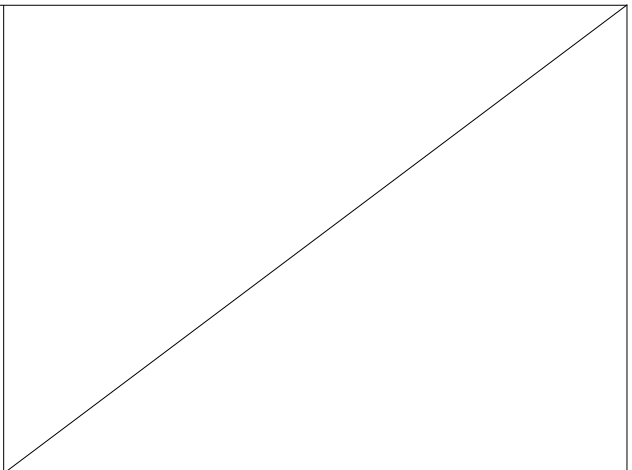
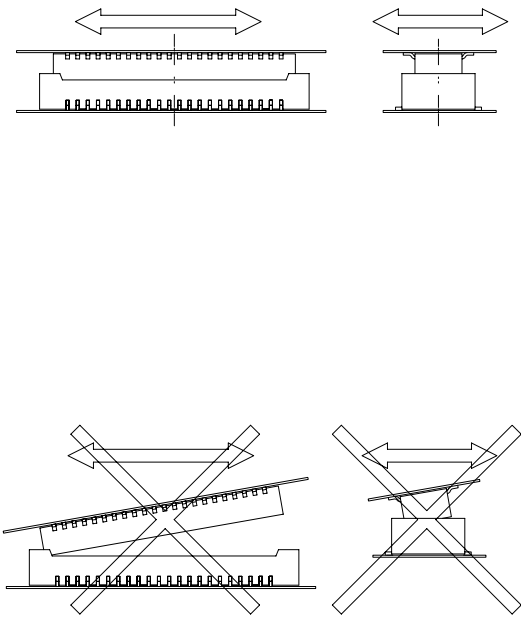
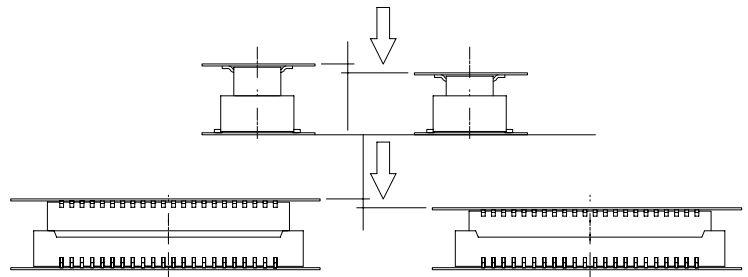
 <p>DF37*-DP-0.4V Header</p> <p>DF37*-DS-0.4V Receptacle</p>	
	<p>Keep the connectors parallel to each other when positioning. The connectors will self-align in horizontal directions.</p> <p>Do not attempt to mate the connectors starting at one end or side.</p>
	<p>Press-down even until fully mated.</p>

◆ Handling Precautions When Un-mating Connectors

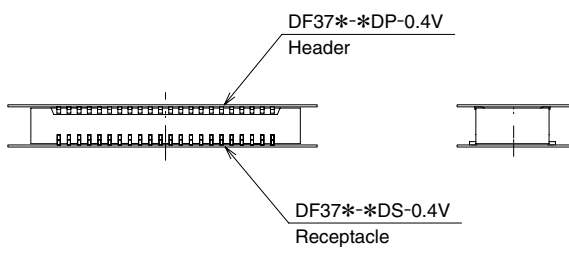
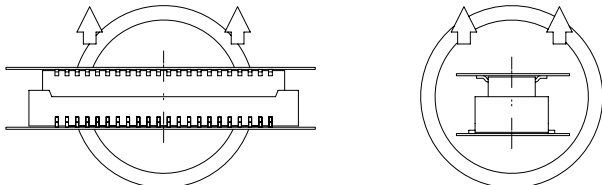
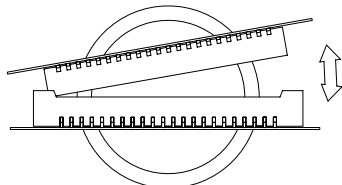
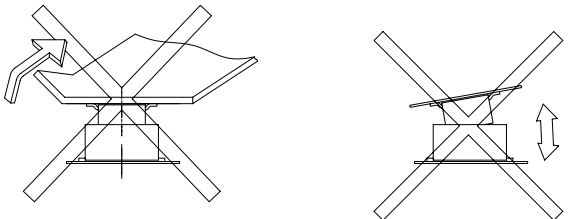
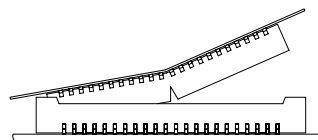
 <p>DF37*-DP-0.4V Header</p> <p>DF37*-DS-0.4V Receptacle</p>	<p>Fully mated</p>
	<p>Lift even, keeping both connectors parallel to each other</p>
 <p>Pitch orientation</p>	<p>When handling, circumstances may prevent the connectors from being kept parallel when un-mating. One end may be lifted as shown. However, to use this procedure the connector must be mounted on sufficiently rigid circuit board.</p> <p>Any deflection of the board during this operation may result in damage to the connector or solder joints.</p>
 <p>Corner orientation</p> <p>Width orientation</p>	<p>Do not attempt to start the un-mating of the connectors from one side or corner.</p> <p>Failure to exercise caution when un-mating the connectors mounted on the non-rigid FPC may also result in connector breakage.</p> <p>It is the responsibility of the user to perform verification of the repeated mating / un-mating cycles with the connectors mounted on the applicable FPC.</p>
	<p>When the rigidity of the FPC is low, there is a risk that the connector could break as illustrated in the diagram at left.</p> <p>Please use the connectors after performing a check of repeated operation with the FPC that the customer will be using.</p> <p>Evaluative results of FPC rigidity and various items are available. Please inquire.</p>