



100 Hz to 1.00 MHz
Fixed Frequency

32-Pin DIP
8-, 6-, 4-Pole Filters

Description

The D01 Series of small, fixed-frequency, linear active DIP filters provide high performance linear, multi-pole filtering in a compact package, with a broad range of pole configurations. These Butterworth and Bessel low-pass filters combine the excellent performance of linear multi-pole filter design with the space saving of the dual in-line package (DIP). Each model comes factory tuned to a user-specified corner frequency between 100Hz and 1 MHz. These fully self-contained units require no external components or adjustments. They operate with dynamic input voltage range from non-critical $\pm 2.5V$ to $\pm 7.5V$ power supplies.

Features/Benefits:

- Low harmonic distortion and wide signal-to-noise ratio to 12 bit resolution
- Compact DIP design minimizes board space requirements
- Plug-in ready-to-use, reducing engineering design and manufacturing time
- Factory tuned, no external clocks or adjustments needed
- Broad range of pole configurations and corner frequencies to meet a wide range of applications

Applications

- Anti-alias filtering
- Data acquisition systems
- Video systems
- Communication systems and electronics
- Medical electronics equipment and research
- Aerospace, navigation and sonar applications
- Sound and vibration testing
- Real and compressed time data analysis
- Noise elimination
- Signal reconstruction

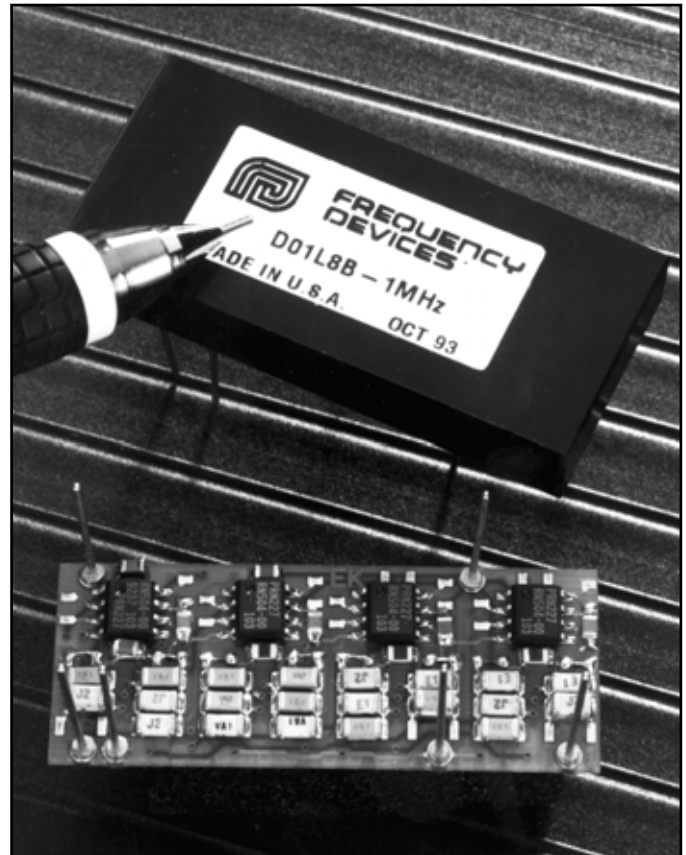

Available Low-Pass Models:

D01L8B	8-pole Butterworth2
D01L6B	6-pole Butterworth2
D01L4B	4-pole Butterworth2
D01L8L	8-pole Bessel3
D01L6L	6-pole Bessel3
D01L4L	4-pole Bessel3

General Specifications:

Pin-out/package data & ordering information4



Fixed Frequency

Model	D01L8B	D01L6B	D01L4B	
Product Specifications				
Transfer Function	8-Pole, Butterworth	6-Pole, Butterworth	4-Pole, Butterworth	
Size	1.80" x 0.80" x 0.30"	1.80" x 0.80" x 0.30"	1.80" x 0.80" x 0.30"	
Range f_c	100 Hz to 1 MHz	100 Hz to 1 MHz	100 Hz to 1 MHz	
Theoretical Transfer Characteristics	Appendix A Page 9	Appendix A Page 8	Appendix A Page 7	
Passband Ripple (theoretical)	0.0 dB	0.0 dB	0.0 dB	
DC Voltage Gain (non-inverting)	0 ± 0.1 dB max. 0 ± 0.02 dB typ.	0 ± 0.1 dB max. 0 ± 0.02 dB typ.	0 ± 0.1 dB max. 0 ± 0.2 dB typ.	
Stopband Attenuation Rate	48 dB/octave	36 dB/octave	24 dB/octave	
Cutoff Frequency Stability	f_c ± 5% max. ± 0.02%/°C	f_c ± 5% max. ± 0.02%/°C	f_c ± 5% max. ± 0.02%/°C	
Amplitude Phase	-3 dB -360°	-3 dB -270°	-3 dB -180°	
Filter Attenuation (theoretical)	0.12 dB 0.80 f_c 3.01 dB 1.00 f_c 60.0 dB 2.37 f_c 80.0 dB 3.16 f_c	0.12 dB 0.80 f_c 3.01 dB 1.00 f_c 60.0 dB 3.16 f_c 80.0 dB 4.64 f_c	0.12 dB 0.80 f_c 3.01 dB 1.00 f_c 60.0 dB 5.62 f_c 80.0 dB 10.0 f_c	
Phase Match¹				
Amplitude Accuracy¹				
Total Harmonic Distortion @ 2.5 V_{RMS}	1 kHz < -80 dB typ. 100 kHz < -65 dB typ.	1 kHz < -80 dB typ. 100 kHz < -65 dB typ.	1 kHz < -80 dB typ. 100 kHz < -65 dB typ.	
Wide Band Noise (20 Hz - 4 MHz)	250 μVrms typ.	160 μVrms typ.	70 μVrms typ.	
Narrow Band Noise (20 Hz - 100 kHz)	30 μVrms typ.	20 μVrms typ.	20 μVrms typ.	
Filter Mounting Assembly	NA	NA	NA	

1. Phase Match and Amplitude Accuracy in the pass band are within ± 5% max. of the theoretical transfer characteristics.

NA - Not available



Fixed Frequency

Model	D01L8L	D01L6L	D01L4L	
Product Specifications				
Transfer Function	8-Pole, Bessel	6-Pole, Bessel	4-Pole, Bessel	
Size	1.80" x 0.80" x 0.30"	1.80" x 0.80" x 0.30"	1.80" x 0.80" x 0.30"	
Range f_c	100 Hz to 1 MHz	100 Hz to 1 MHz	100 Hz to 1 MHz	
Theoretical Transfer Characteristics	Appendix A Page 4	Appendix A Page 3	Appendix A Page 2	
Passband Ripple (theoretical)	0.0 dB	0.0 dB	0.0 dB	
DC Voltage Gain (non-inverting)	0 ± 0.1 dB max. 0 ± 0.2 dB typ.	0 ± 0.1 dB max. 0 ± 0.2 dB typ.	0 ± 0.1 dB max. 0 ± 0.2 dB typ.	
Stopband Attenuation Rate	48 dB min.	36 dB/octave	24 dB/octave	
Cutoff Frequency Stability Amplitude Phase	f_c ± 5% max. ± 0.02%/°C -3 dB -182°	f_c ± 5% max. ± 0.02%/°C -3 dB -155°	f_c ± 5% max. ± 0.02%/°C -3 dB -121°	
Filter Attenuation (theoretical)	1.91 dB 0.80 f_c 3.01 dB 1.00 f_c 60.0 dB 4.52 f_c 80.0 dB 6.07 f_c	1.91 dB 0.80 f_c 3.01 dB 1.00 f_c 60.0 dB 5.41 f_c 80.0 dB 7.99 f_c	1.91 dB 0.80 f_c 3.01 dB 1.00 f_c 60.0 dB 8.48 f_c 80.0 dB 15.12 f_c	
Phase Match¹				
Amplitude Accuracy¹				
Total Harmonic Distortion @ 2.5 V_{RMS}	1 kHz < -80 dB typ. 100 kHz < -65 dB typ.	1 kHz < -80 dB typ. 100 kHz < -65 dB typ.	1 kHz < -80 dB typ. 100 kHz < -65 dB typ.	
Wide Band Noise	250 μV_{RMS} typ.	160 μV_{RMS} typ.	70 μV_{RMS} typ.	
Narrow Band Noise	30 μV_{RMS} typ.	20 μV_{RMS} typ.	20 μV_{RMS} typ.	
Filter Mounting Assembly	NA	NA	NA	

1. Phase Match and Amplitude Accuracy in the pass band are within ± 5% max. of the theoretical transfer characteristics.
NA - Not available



D01 Series

Specification

(25°C and $V_s \pm 5$ Vdc)

Pin-Out and Package Data Ordering Information

Analog Input Characteristics ¹

Impedance	250 k Ω min.
Voltage Range	± 3.5 Vpeak
Max. Safe Voltage	$\pm V_s$

Analog Output Characteristics

Impedance (Closed Loop)	<1 Ω typ.
Linear Operating Range	± 5 V
Maximum Current ²	± 30 mA
Offset Voltage ³	± 10 mV max.
Offset Temp. Coeff.	50 mV/°C

Power Supply ($\pm V$)

Rated Voltage	± 7.5 Vdc
Operating Range	± 2.5 to ± 7.5 Vdc
Maximum Safe Voltage	± 7.5 Vdc
Quiescent Current	
8-Pole	± 30 mA max.
6-Pole	± 23 mA max.
4-Pole	± 15 mA max.

Temperature

Operating	0 to +70°C
Storage	-25 to +85°C

Notes:

1. Input and output signal voltage referenced to supply common.
2. Output is short circuit protected to common.
DO NOT CONNECT TO $\pm V_s$.
3. Adjustable to zero.
4. Units operate with or without of fset pin connected.

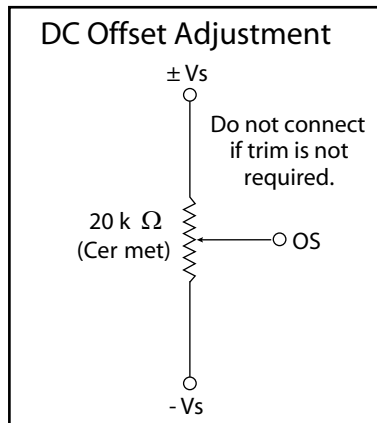

D01 package OUTLINE

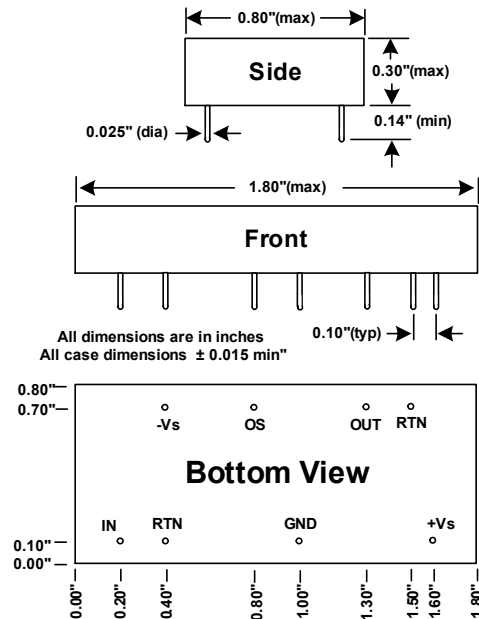

Ordering Information

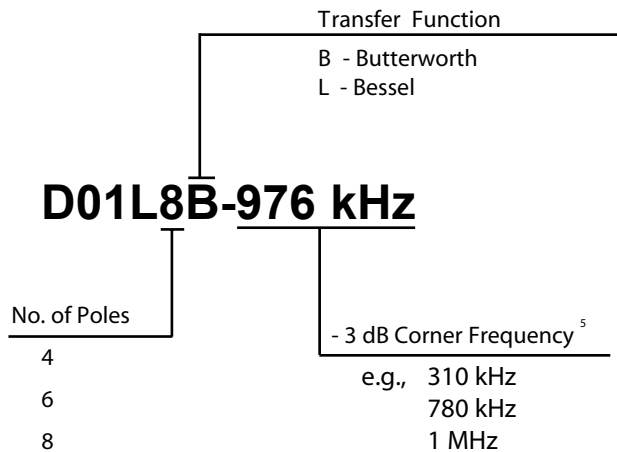

5. How to Specify Corner Frequencies: Corner frequencies are specified by attaching a three digit frequency designator to the basic model number. Corner frequencies can range from 100Hz to 1 MHz.

We hope the information given here will be helpful. The information is based on data and our best knowledge, and we consider the information to be true and accurate. Please read all statements, recommendations or suggestions herein in conjunction with our conditions of sale which apply to all goods supplied by us. We assume no responsibility for the use of these statements, recommendations or suggestions, nor do we intend them as a recommendation for any use which would infringe any patent or copyright. IN-00D01-04



Appendix A

Theoretical Transfer Characteristics

f/fc (Hz)	Amp (dB)	Phase (deg)	Delay ¹ (sec)
0.00	0.00	0.00	.336
0.10	-0.028	-12.1	.336
0.20	-0.111	-24.2	.336
0.30	-0.251	-36.3	.336
0.40	-0.448	-48.4	.336
0.50	-0.705	-60.6	.336
0.60	-1.02	-72.7	.336
0.70	-1.41	-84.8	.336
0.80	-1.86	-96.8	.335
0.85	-2.11	-103	.334
0.90	-2.40	-109	.333
0.95	-2.69	-115	.332
1.00	-3.01	-121	.330
1.10	-3.71	-133	.325
1.20	-4.51	-144	.318
1.30	-5.39	-156	.308
1.40	-6.37	-166	.295
1.50	-7.42	-177	.280
1.60	-8.54	-187	.263
1.70	-9.71	-195	.246
1.80	-10.9	-204	.228
1.90	-12.2	-212	.211
2.00	-13.4	-219	.194
2.25	-16.5	-235	.158
2.50	-19.5	-248	.129
2.75	-22.4	-259	.107
3.00	-25.1	-267	.089
3.25	-27.6	-275	.076
3.50	-30.0	-281	.065
4.00	-34.4	-291	.049
5.00	-41.9	-305	.031
6.00	-48.1	-315	.021
7.00	-53.4	-321	.016
8.00	-58.0	-326	.012
9.00	-62.0	-330	.009
10.0	-65.7	-333	.008

Frequency Response

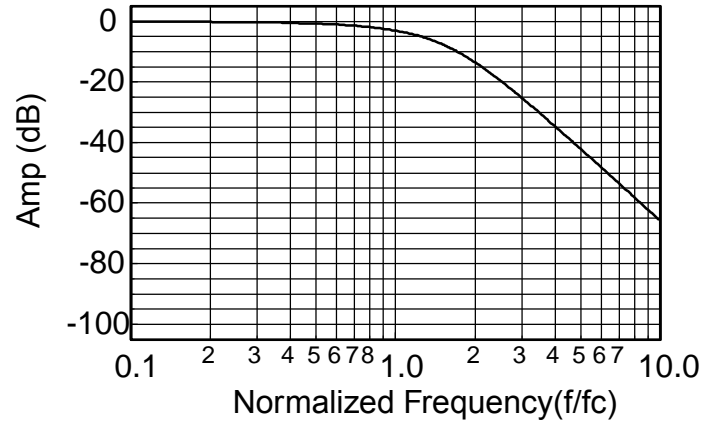

Delay (Normalized)

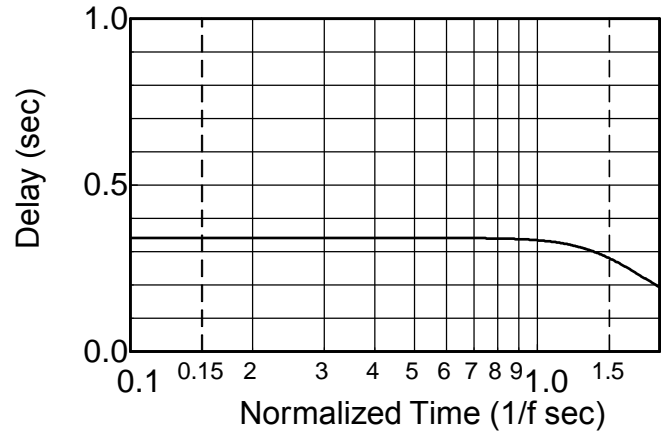

Step Response

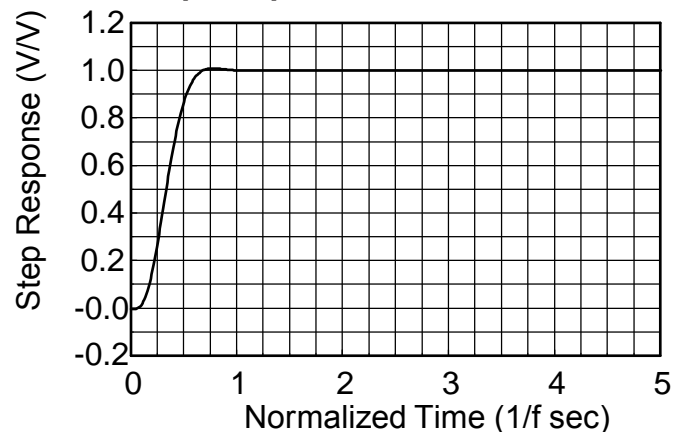

1. Normalized Group Delay:

The above delay data is normalized to a corner frequency of 1.0Hz. The actual delay is the normalized delay divided by the actual corner frequency (fc).

$$\text{Actual Delay} = \frac{\text{Normalized Delay}}{\text{Actual Corner Frequency (fc) in Hz}}$$



Appendix A

Theoretical Transfer Characteristics

f/fc (Hz)	Amp (dB)	Phase (deg)	Delay ¹ (sec)
0.00	0.00	0.00	.430
0.10	-0.029	-15.5	.430
0.20	-0.116	-31.0	.430
0.30	-0.261	-46.5	.430
0.40	-0.465	-62.0	.430
0.50	-0.728	-77.4	.430
0.60	-1.05	-92.9	.430
0.70	-1.44	-108	.430
0.80	-1.89	-124	.430
0.85	-2.15	-132	.430
0.90	-2.42	-139	.430
0.95	-2.70	-147	.430
1.00	-3.01	-155	.430
1.10	-3.68	-170	.429
1.20	-4.44	-186	.428
1.30	-5.29	-201	.426
1.40	-6.23	-216	.422
1.50	-7.29	-232	.416
1.60	-8.46	-246	.401
1.70	-9.74	-261	.393
1.80	-11.1	-275	.376
1.90	-12.6	-287	.357
2.00	-14.2	-300	.335
2.25	-18.3	-328	.279
2.50	-22.6	-351	.228
2.75	-26.7	-369	.187
3.00	-30.7	-385	.156
3.25	-34.5	-398	.131
3.50	-38.1	-408	.111
4.00	-44.7	-426	.083
5.00	-55.9	-449	.052
6.00	-65.2	-465	.036
7.00	-73.2	-476	.026
8.00	-80.1	-484	.020
9.00	-86.2	-490	.015
10.0	-91.6	-495	.013

Frequency Response

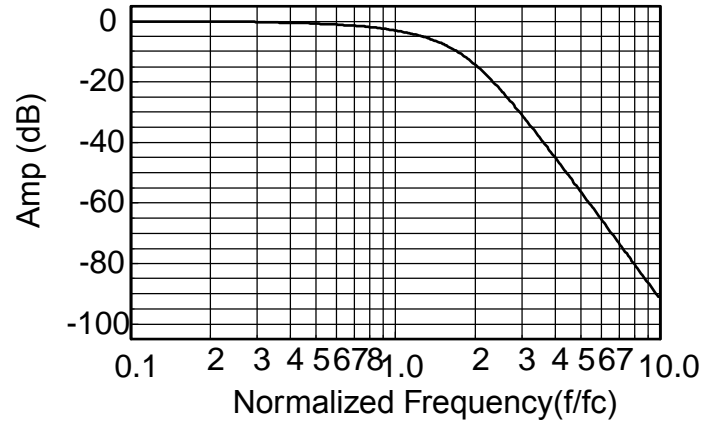

Delay (Normalized)

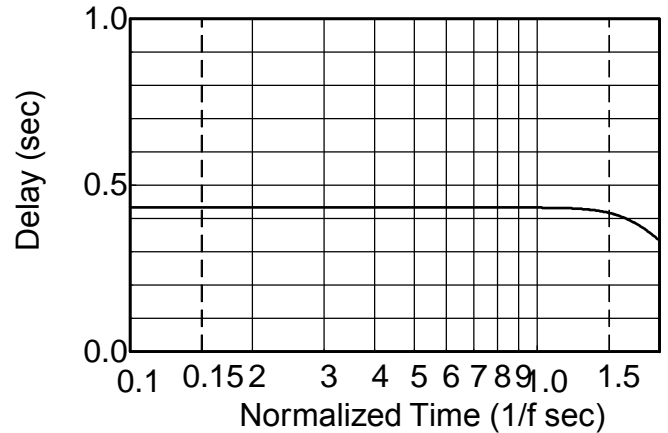

Step Response

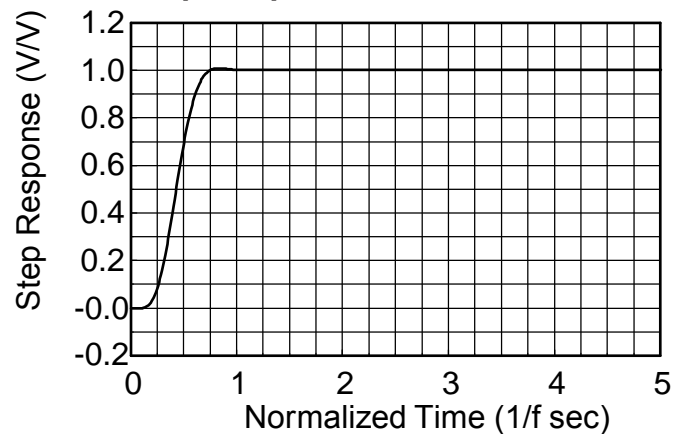

1. Normalized Group Delay:

The above delay data is normalized to a corner frequency of 1.0Hz. The actual delay is the normalized delay divided by the actual corner frequency (fc).

$$\text{Actual Delay} = \frac{\text{Normalized Delay}}{\text{Actual Corner Frequency (fc) in Hz}}$$



Appendix A

Theoretical Transfer Characteristics

f/fc (Hz)	Amp (dB)	Phase (deg)	Delay ¹ (sec)
0.00	0.00	0.00	.506
0.10	-0.029	-18.2	.506
0.20	-0.117	-36.4	.506
0.30	-0.264	-54.7	.506
0.40	-0.470	-72.9	.506
0.50	-0.737	-91.1	.506
0.60	-1.06	-109	.506
0.70	-1.45	-128	.506
0.80	-1.91	-146	.506
0.85	-2.16	-155	.506
0.90	-2.42	-164	.506
0.95	-2.71	-173	.506
1.00	-3.01	-182	.506
1.10	-3.67	-200	.506
1.20	-4.40	-219	.506
1.30	-5.20	-237	.506
1.40	-6.10	-255	.505
1.50	-7.08	-273	.504
1.60	-8.16	-291	.502
1.70	-9.36	-309	.498
1.80	-10.7	-327	.492
1.90	-12.1	-345	.482
2.00	-13.7	-362	.468
2.25	-18.1	-402	.417
2.50	-23.1	-436	.352
2.75	-28.3	-465	.291
3.00	-33.4	-489	.241
3.25	-38.3	-509	.201
3.50	-43.1	-526	.170
4.00	-51.8	-552	.126
5.00	-66.8	-587	.077
6.00	-79.2	-610	.052
7.00	-89.8	-626	.038
8.00	-99.0	-638	.029
9.00	-107	-647	.023
10.0	-114	-655	.018

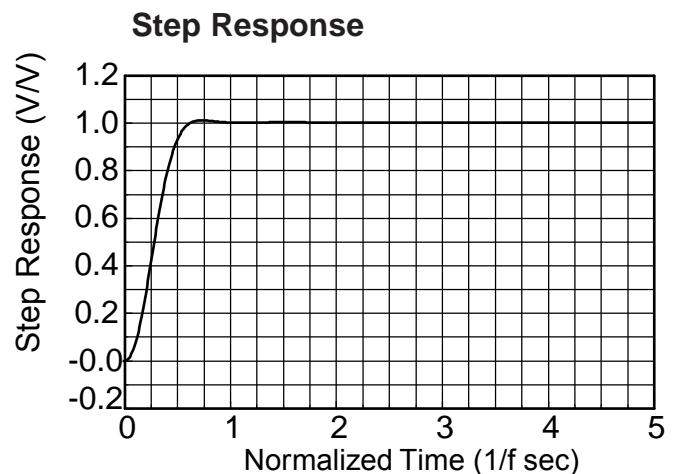
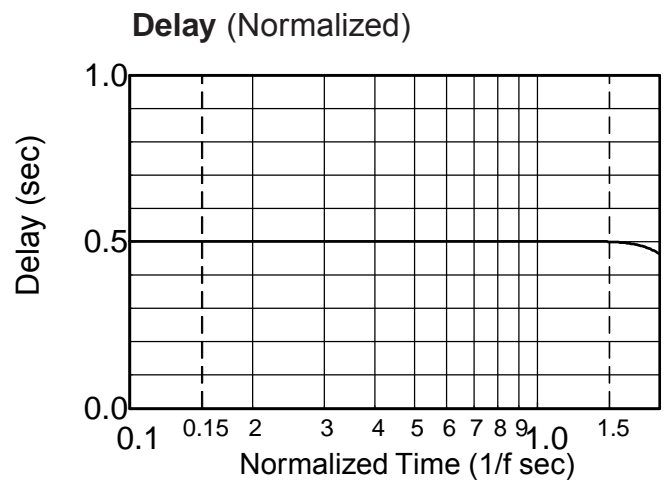
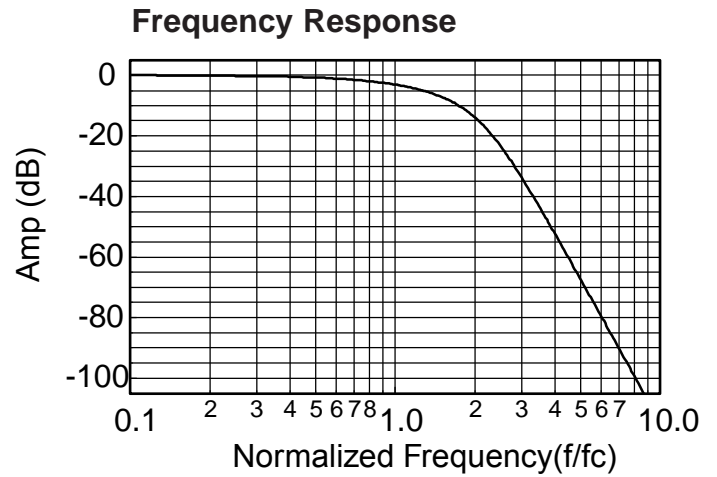

¹ **Normalized Group Delay:**
The above delay data is normalized to a corner frequency of 1.0Hz. The actual delay is the normalized delay divided by the actual corner frequency (fc).

$$\text{Actual Delay} = \frac{\text{Normalized Delay}}{\text{Actual Corner Frequency (fc) in Hz}}$$



Appendix A

Theoretical Transfer Characteristics

f/fc (Hz)	Amp (dB)	Phase (deg)	Delay ¹ (sec)
0.00	0.00	0.00	.416
0.10	0.00	-15.0	.418
0.20	0.00	-30.1	.423
0.30	-0.00	-45.5	.433
0.40	-0.003	-61.4	.449
0.50	-0.017	-78.0	.474
0.60	-0.072	-95.7	.511
0.70	-0.243	-115	.558
0.80	-0.674	-136	.604
0.85	-1.047	-147	.619
0.90	-1.555	-158	.622
0.95	-2.21	-169	.612
1.00	-3.01	-180	.588
1.10	-4.97	-200	.513
1.20	-7.24	-217	.427
1.30	-9.62	-231	.350
1.40	-12.0	-242	.289
1.50	-14.3	-252	.241
1.60	-16.4	-260	.204
1.70	-18.5	-266	.175
1.80	-20.5	-272	.152
1.90	-22.3	-277	.134
2.00	-24.1	-282	.119
2.25	-28.2	-291	.091
2.50	-31.8	-299	.072
2.75	-35.1	-304	.059
3.00	-38.2	-309	.049
3.25	-41.0	-313	.041
3.50	-43.5	-317	.035
4.00	-48.2	-322	.027
5.00	-55.9	-330	.017
6.00	-62.3	-335	.012
7.00	-67.6	-339	.009
8.00	-72.2	-341	.007
9.00	-76.3	-343	.005
10.0	-80.0	-345	.004

Frequency Response

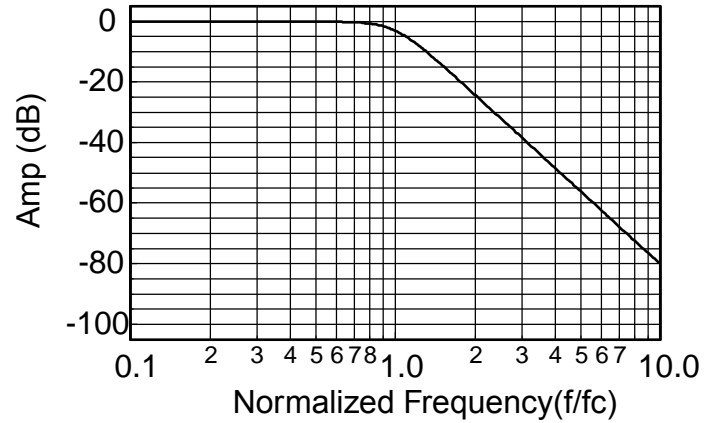

Delay (Normalized)

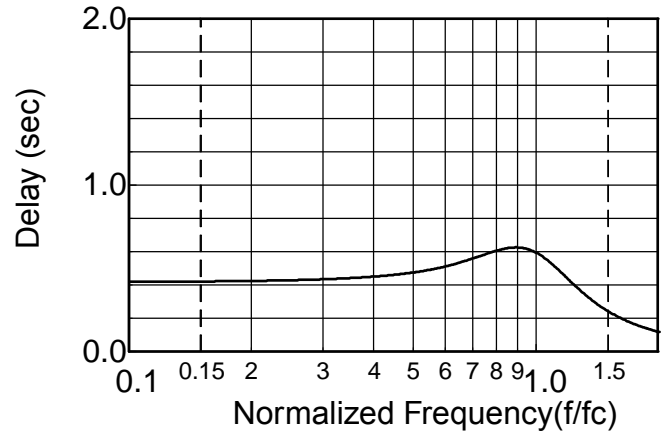

Step Response

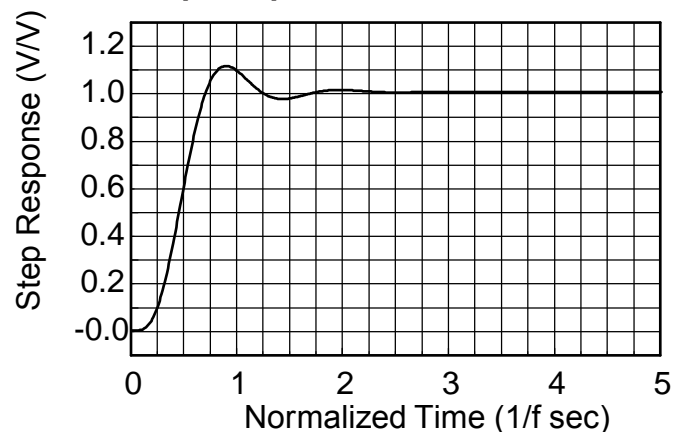

1. Normalized Group Delay:

The above delay data is normalized to a corner frequency of 1.0Hz. The actual delay is the normalized delay divided by the actual corner frequency (fc).

$$\text{Actual Delay} = \frac{\text{Normalized Delay}}{\text{Actual Corner Frequency (fc) in Hz}}$$



Appendix A

Theoretical Transfer Characteristics

f/fc (Hz)	Amp (dB)	Phase (deg)	Delay ¹ (sec)
0.00	0.00	0.00	.615
0.10	0.00	-22.2	.617
0.20	0.00	-44.5	.624
0.30	0.00	-67.2	.637
0.40	0.00	-90.4	.656
0.50	-0.001	-115	.685
0.60	-0.009	-140	.731
0.70	-0.060	-167	.803
0.80	-0.289	-198	.911
0.85	-0.578	-215	.970
0.90	-1.080	-233	1.02
0.95	-1.88	-252	1.03
1.00	-3.01	-270	1.00
1.10	-6.17	-304	.845
1.20	-9.96	-331	.660
1.30	-13.9	-352	.518
1.40	-17.6	-368	.417
1.50	-21.2	-382	.345
1.60	-24.5	-393	.291
1.70	-27.7	-403	.251
1.80	-30.6	-412	.219
1.90	-33.5	-419	.193
2.00	-36.1	-425	.171
2.25	-42.3	-439	.132
2.50	-47.8	-450	.105
2.75	-52.7	-458	.086
3.00	-57.3	-465	.071
3.25	-61.4	-471	.060
3.50	-65.3	-476	.052
4.00	-72.2	-484	.039
5.00	-83.9	-496	.025
6.00	-93.4	-503	.017
7.00	-101	-508	.012
8.00	-108	-512	.0097
9.00	-115	-515	.0076
10.0	-120	-518	.0062

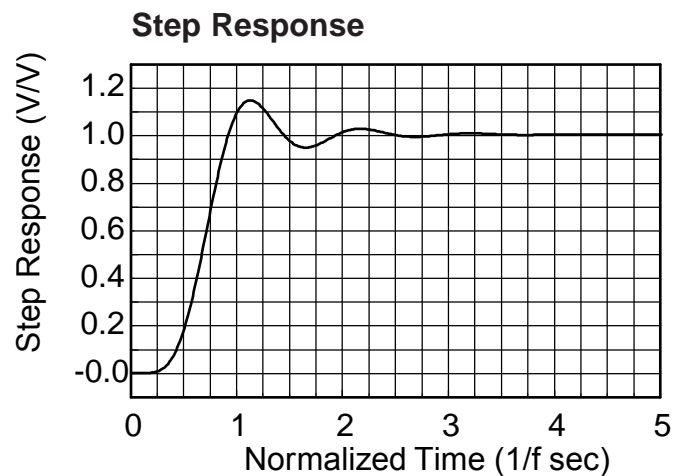
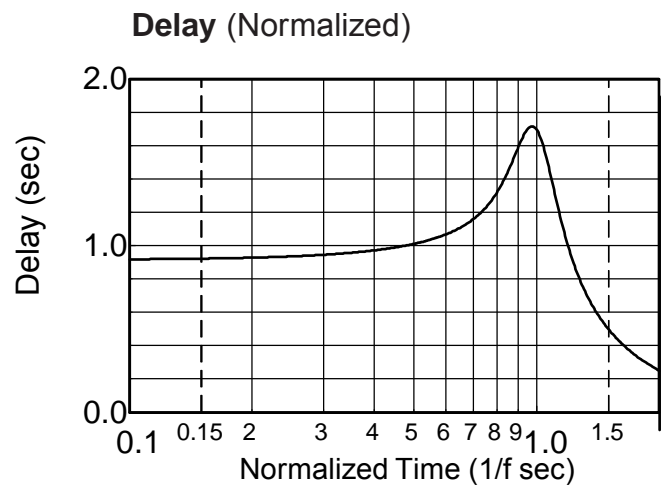
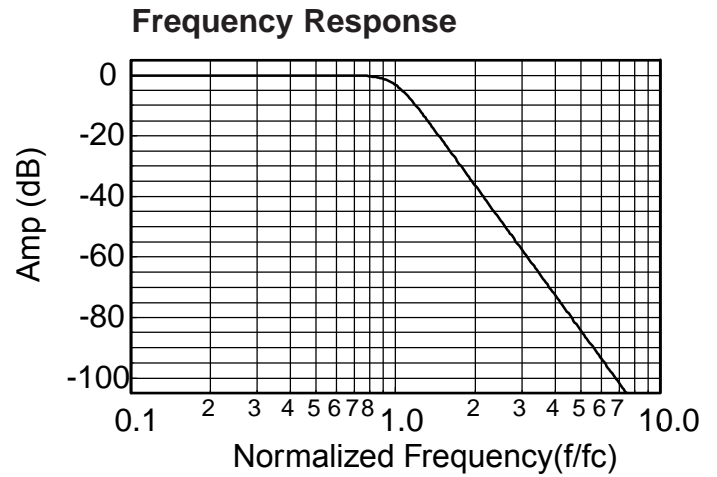

1. Normalized Group Delay:

The above delay data is normalized to a corner frequency of 1.0Hz. The actual delay is the normalized delay divided by the actual corner frequency (fc).

$$\text{Actual Delay} = \frac{\text{Normalized Delay}}{\text{Actual Corner Frequency (fc) in Hz}}$$



Appendix A

Theoretical Transfer Characteristics

f/fc (Hz)	Amp (dB)	Phase (deg)	Delay ¹ (sec)
0.00	0.00	0.00	.816
0.10	0.00	-29.4	.819
0.20	0.00	-59.0	.828
0.30	0.00	-89.1	.843
0.40	0.00	-120	.867
0.50	0.00	-152	.903
0.60	-0.001	-185	.956
0.70	-0.014	-221	1.04
0.80	-0.121	-261	1.19
0.85	-0.311	-283	1.29
0.90	-0.738	-307	1.40
0.95	-1.58	-333	1.48
1.00	-3.01	-360	1.46
1.10	-7.48	-408	1.17
1.20	-12.9	-445	.873
1.30	-18.2	-472	.672
1.40	-23.4	-494	.540
1.50	-28.2	-511	.448
1.60	-32.7	-526	.380
1.70	-36.9	-539	.328
1.80	-40.8	-550	.287
1.90	-44.6	-560	.253
2.00	-48.2	-568	.226
2.25	-56.3	-586	.174
2.50	-63.7	-600	.139
2.75	-70.3	-611	.113
3.00	-76.3	-621	.094
3.25	-81.9	-629	.080
3.50	-87.1	-635	.069
4.00	-96.3	-646	.052
5.00	-112	-661	.033
6.00	-125	-671	.023
7.00	-135	-678	.017
8.00	-144	-683	.013
9.00	-153	-687	.010
10.0	-160	-691	.008

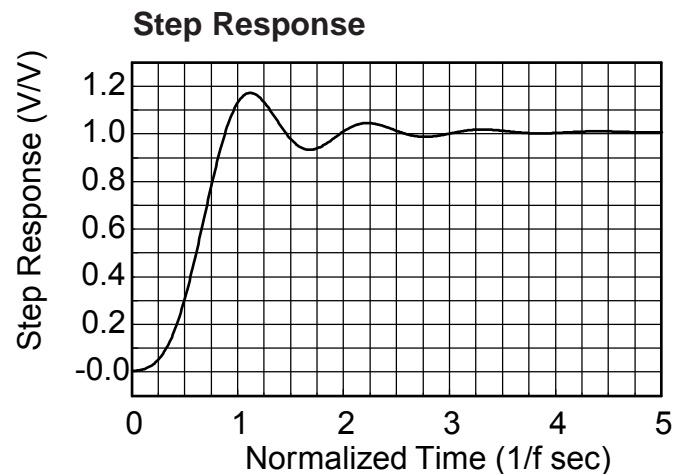
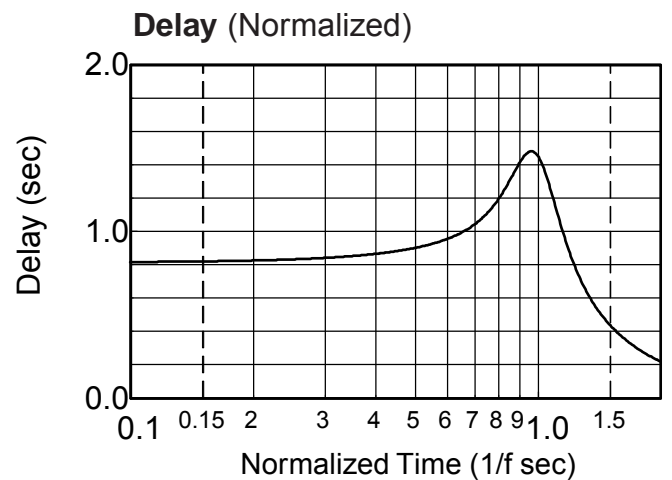
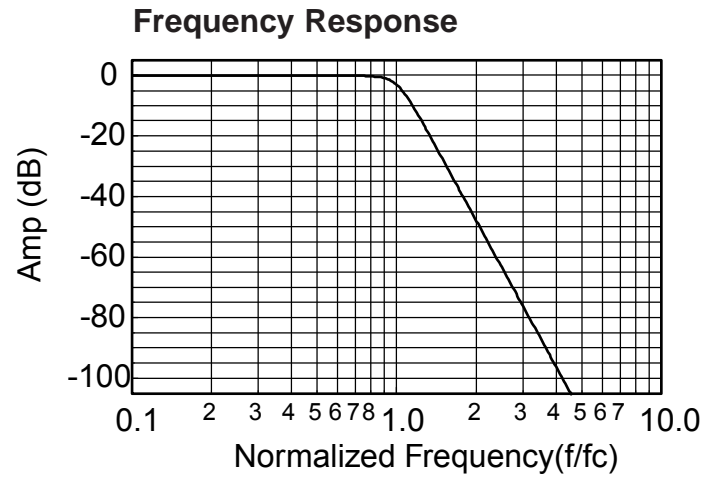

1. Normalized Group Delay:

The above delay data is normalized to a corner frequency of 1.0Hz. The actual delay is the normalized delay divided by the actual corner frequency (fc).

$$\text{Actual Delay} = \frac{\text{Normalized Delay}}{\text{Actual Corner Frequency (fc) in Hz}}$$