

PLEASE CHECK WWW.MOLEX.COM FOR LATEST PART INFORMATION

Part Number: [0481917000](#)
Status: **Active**
Overview:
Description: 0.80mm (.031") Pitch Edge Card Connector, Vertical, SMT, 40 Circuits, 0.38µm (15µ") Gold (Au) Plating, Lead Free

Agency Certification

CSA	LR 19980
UL	E29179

General

Product Family	Edge Card Connectors
Series	48191
Component Type	Edgecard to PCB
Overview	edge_card_connectors
Product Name	Edge Card

Physical

Circuits (Loaded)	40
Circuits (maximum)	40
Circuits Detail	All Signal
Durability (mating cycles max)	100
Entry Angle	Vertical (Top Entry)
Flammability	94V-0
Keying to Mating Part	Yes
Material - Plating Mating	Gold
Material - Plating Termination	Tin
PCB Locator	Yes
PCB Retention	Yes
Packaging Type	Tube
Pitch - Mating Interface (in)	0.031 In
Pitch - Mating Interface (mm)	0.80 mm
Pitch - Term. Interface (in)	0.031 In
Pitch - Term. Interface (mm)	0.80 mm
Plating min: Mating (µin)	15
Plating min: Mating (µm)	0.38
Plating min: Termination (µin)	100
Plating min: Termination (µm)	2.50
Temperature Range - Operating	-40°C to +105°C
Termination Interface: Style	Surface Mount

Electrical

Current - Maximum per Contact	1.7A
Voltage - Maximum	400V AC (RMS)

Material Info

Reference - Drawing Numbers

Packaging Specification	PK-48191-001
Product Specification	PS-48191-001
Sales Drawing	SD-48191-001
Test Summary	TS-48191-001

EU RoHS
ELV and RoHS
Compliant
REACH SVHC
 Not Reviewed
Halogen-Free
Status
Not Reviewed

China RoHS



Need more information on product environmental compliance?

Email productcompliance@molex.com
 For a multiple part number RoHS Certificate of Compliance, [click here](#)

Please visit the [Contact Us](#) section for any non-product compliance questions.

Search Parts in this Series
[48191Series](#)

Mates With
 1.60mm (.063") Thick Edge Card Module

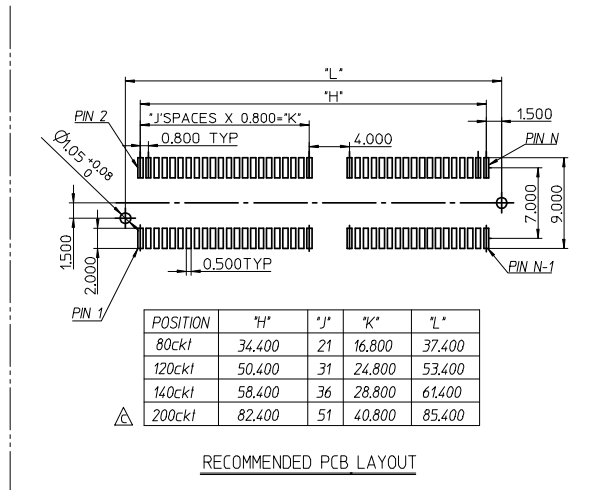
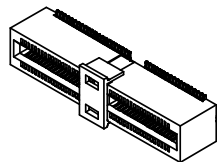
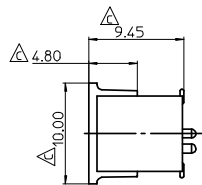
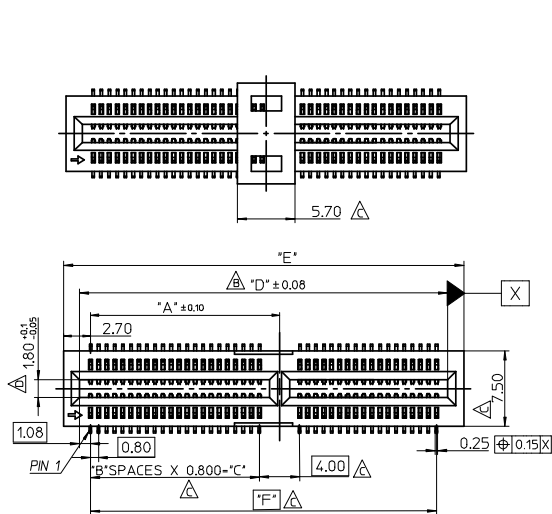

RECOMMENDED PCB LAYOUT

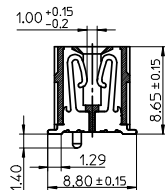
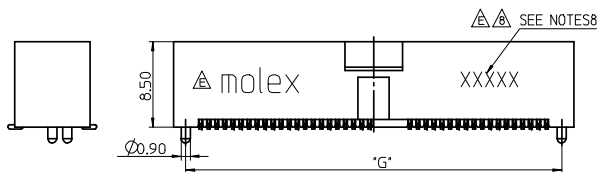

NOTES:

- MATERIAL:
HOUSING: LIQUID CRYSTAL POLYMER 30% GLASS FIBER UL 94V-0 RATED
COLOR: BLACK
CONTACT: PHOSPHOR BRONZE.
- PLATING:
TERMINAL :
CONTACT AREA: SEE TABLE
SOLDER TAIL AREA : 100 MICRONCH MIN. TIN OVER 50 MICRONCH MIN. NICKEL.OVERALL
- PRODUCT SPECIFICATION: PS-48191-001
- PACKAGING SPECIFICATION: PK-48191-001
- TEST SUMMARY : TS-48191-001
- COPLANARITY SHOULD BE 0.1mm MAX
- LEAD FREE AND ROHS COMPLIANCE PRODUCT.
- DATE CODE:XX<YEAR> XX<WEEK> X<LOCATION>

No OF POS	"A"	"B"	"C"	"D"	"E"	"F"	"G"
80ckt	18.80	21	16.80	36.55	39.80	34.40	37.40
120ckt	26.80	31	24.80	52.55	55.80	50.40	53.40
140ckt	30.80	36	28.80	60.55	63.80	58.40	61.40
200ckt	42.80	51	40.80	84.55	87.80	82.40	85.40

48191-6000	200	GOLD 15 MICRONCH
48191-4000	140	GOLD 15 MICRONCH
48191-3000	120	GOLD 15 MICRONCH
48191-2000	80	GOLD 15 MICRONCH
MOLEX P/N	CKT	CONTACT PLATING

REMOVE MATERIAL NO. EC NO: SH2008-0651 DRWN:LIU10 CHKD:YLZHU APPR:HWANG 2008/06/25 2008/08/07	QUALITY SYMBOLS ▽=0 ▽=0	GENERAL TOLERANCES (UNLESS SPECIFIED)		DIMENSION STYLE MM ONLY		SCALE 1:1	DESIGN UNITS METRIC	THIRD ANGLE PROJECTION		
		4 PLACES ± --- ± ---		DRAWN BY TOM		DATE 2005/10/15		TITLE 0.8MM EDGE CARD CONNECTOR SMT TYPE		
		3 PLACES ± --- ± ---		CHECKED BY ALLEN		DATE 2005/10/15		MOLEX INCORPORATED		
		2 PLACES ± 0.25 ± ---		APPROVED BY WILSON		DATE 2005/10/15		MATERIAL NO. SEE TABLE		DOCUMENT NO. SD-48191-001
1 PLACE ± 0.25 ± ---		ANGULAR ± 3 °		DRAFT WHERE APPLICABLE MUST REMAIN WITHIN DIMENSIONS		SHEET NO. 1 OF 3		THIS DRAWING CONTAINS INFORMATION THAT IS PROPRIETARY TO MOLEX INCORPORATED AND SHOULD NOT BE USED WITHOUT WRITTEN PERMISSION		

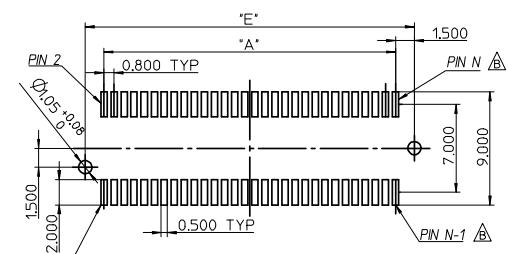
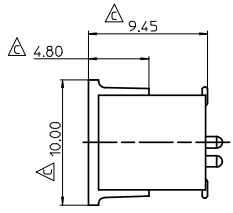
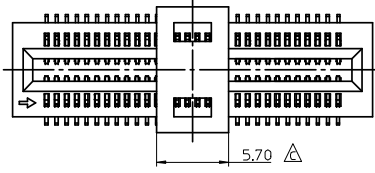

POSITION	"A"	"E"
40ckt	15.200	18.200
60ckt	23.200	26.200
70ckt	27.200	30.200

RECOMMENDED PCB LAYOUT

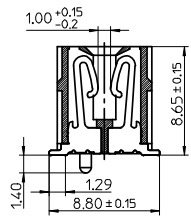
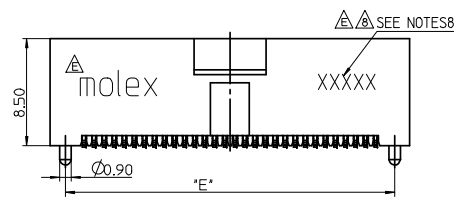
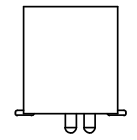
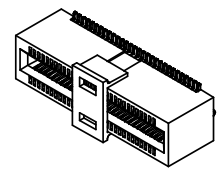
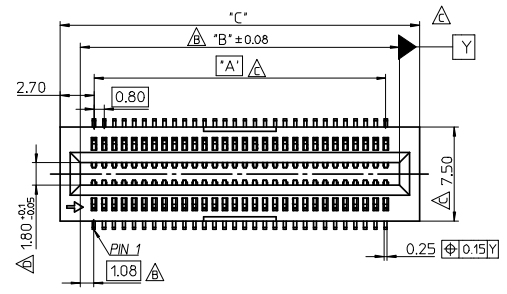

No OF POS	"A"	"B"	"C"	"E"
40ckt	15.20	17.35	20.60	18.20
60ckt	23.20	25.35	28.60	26.20
70ckt	27.20	29.35	32.60	30.20

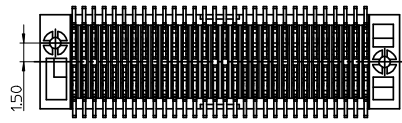

48191-5000	70	GOLD 15 MICRINCH
48191-1000	60	GOLD 15 MICRINCH
48191-7000	40	GOLD 15 MICRINCH
MOLEX P/N	CKT	CONTACT PLATING

REMOVE MATERIAL NO. EC NO: SH2008-0651 TDRW: LLIU10 2008/06/20 CHKD: YLZHU 2008/06/25 APPR: HWANG 2008/08/07	QUALITY SYMBOLS ▽=0 ◁=0	GENERAL TOLERANCES (UNLESS SPECIFIED)		DIMENSION STYLE MM ONLY		SCALE 1:1	DESIGN UNITS METRIC	THIRD ANGLE PROJECTION			
		4 PLACES ± --- ± --- 3 PLACES ± --- ± --- 2 PLACES ± 0.25 ± --- 1 PLACE ± 0.25 ± ---	mm INCH	DRAWN BY TOM	DATE 2005/10/15	TITLE 0.8MM EDGE CARD CONNECTOR SMT TYPE					
		ANGULAR ± 3 °		CHECKED BY ALLEN	DATE 2005/10/15	APPROVED BY WILSON					
		DRAFT WHERE APPLICABLE MUST REMAIN WITHIN DIMENSIONS		MATERIAL NO. SEE TABLE		DOCUMENT NO. SD-48191-001		SHEET NO. 2 OF 3			

△ RECOMMENDED PCB MODULE LAYOUT (FOR 80~200CKT)

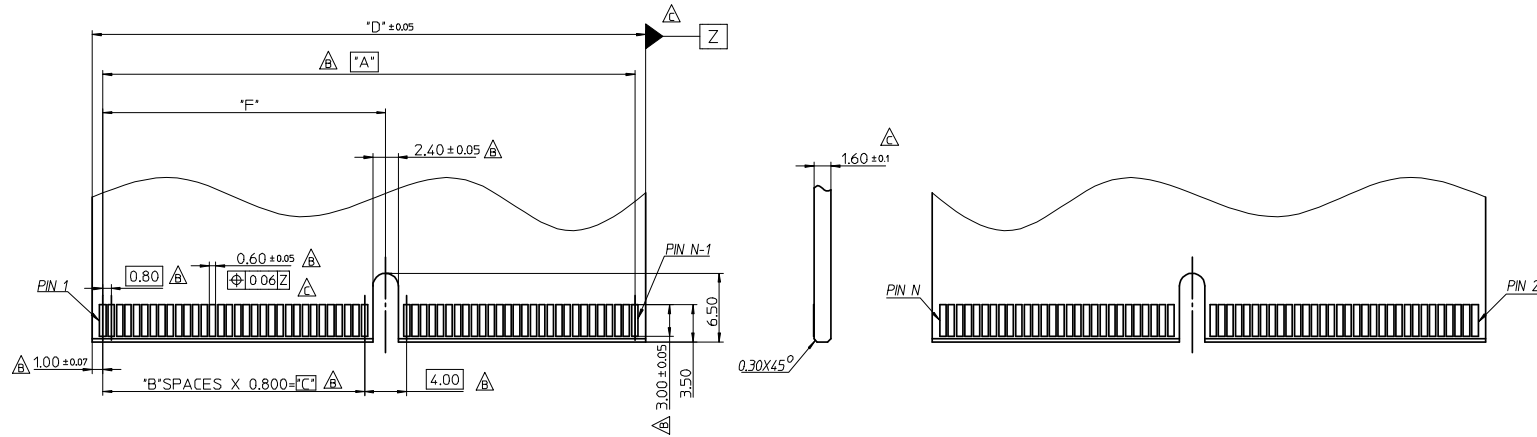

▽ △ RECOMMENDED PCB MODULE LAYOUT (FOR 40~70CKT)

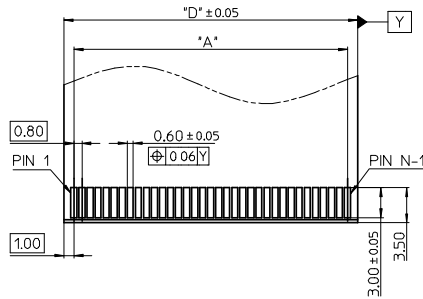

POSITION	"A"	"B"	"C"	"D"	"F"
40ckt	15.200	N/A	N/A	17.200	N/A
60ckt	23.200	N/A	N/A	25.200	N/A
70ckt	27.200	N/A	N/A	29.200	N/A
80ckt	34.400	21	16.800	36.400	18.800
120ckt	50.400	31	24.800	52.400	26.800
140ckt	58.400	36	28.800	60.400	30.800
200ckt	82.400	51	40.800	84.400	42.800

REMOVE MATERIAL NO. EC NO: SH2008-0651 DRWN: LIU10 2008/06/20 CHKD: YLZHU 2008/06/25 APPR: HWANG 2008/08/07	QUALITY SYMBOLS ▽ = 0 ∇ = 0	GENERAL TOLERANCES (UNLESS SPECIFIED)		DIMENSION STYLE MM ONLY	SCALE 1:1	DESIGN UNITS METRIC	THIRD ANGLE PROJECTION	
				DRAWN BY TOM	DATE 2005/10/15	TITLE 0.8MM EDGE CARD CONNECTOR SMT TYPE		
				CHECKED BY ALLEN	DATE 2005/10/15	MOLEX INCORPORATED		
				APPROVED BY WILSON	DATE 2005/10/15	MATERIAL NO. SEE TABLE	DOCUMENT NO. SD-48191-001	SHEET NO. 3 OF 3
		DRAFT WHERE APPLICABLE MUST REMAIN WITHIN DIMENSIONS		THIS DRAWING CONTAINS INFORMATION THAT IS PROPRIETARY TO MOLEX INCORPORATED AND SHOULD NOT BE USED WITHOUT WRITTEN PERMISSION				