

Features

1. Compact
(adoption of small jack for mini plug JIS C6560)
2. Thin type transmitter unit.
3. Both optical and electrical signal can be distinguished and transmitted.
4. Signal transmission speed :
MAX. 13.2 Mbps (NRZ signal)
5. Operating voltage : 2.75 to 5.25 V
6. L/F pitch : 2.0 mm

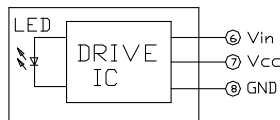
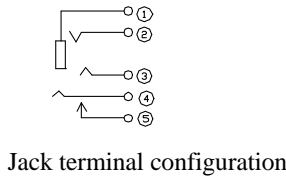

Internal equivalent circuit

Outline Dimensions

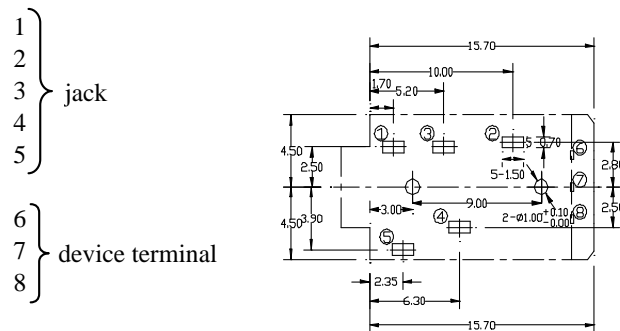
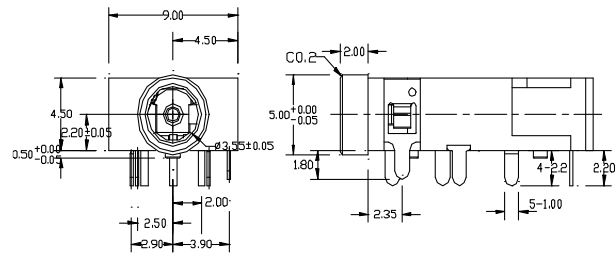

NOTES:

Tolerance is $\pm 0.3\text{mm}$ unless otherwise noted.

Absolute Maximum Ratings

(Photoelectric conversion element)

@TA=25°C

Parameter	Symbol	Rating	Unit
Supply voltage	V _{cc}	-0.5 to + 7.0	V
Input voltage	V _{in}	-0.5 to V _{cc} +0.5	V
Operating temperature	T _{opr}	-20 to +70	°C
Storage temperature	T _{stg}	-30 to +80	°C
Soldering temperature ^{*1}	T _{sol}	260	°C

*1 For 5s (2 times or less)

Absolute Maximum Rating(Jack)

Parameter	Symbol	Rating	Unit
Total power dissipation	P _{tot}	D.C. 12V, 1A	-
Operating temperature	T _{opr}	-20 to +70	°C
Storage temperature	T _{stg}	-30 to +80	°C
Soldering temperature ^{*1}	T _{sol}	260	°C
Isolation voltage ^{*2}	V _{iso}	A.C. 500V rms	-

*1 For 5s (2 times or less)

*2 For 1 min

Recommended Operating Conditions

Parameter	Symbol	MIN.	TYP.	MAX.	Unit
Operating supply voltage	V _{cc}	2.75	---	5.25	V
Operating transfer rate	T	---	---	13.2	Mbps

Electro-Optical Characteristics

Parameter	Symbol	Conditions	MIN.	TYP.	MAX.	Unit
Peak emission wavelength	λ_p		630	660	690	nm
Optical power output coupling with fiber	P _c	Refer to Fig. 1	-21	-18	-15	dBm
Dissipation current	I _{cc}	Refer to Fig. 2	---	8	13	mA
High level input voltage	V _{iH}	Refer to Fig. 2	2.0	---	V _{cc}	V
Low level input voltage	V _{iL}	Refer to Fig. 2	---	---	0.8	V
Low to High delay time	t _{pLH}	Refer to Fig. 3	---	100	180	ns
High to Low delay time	t _{pHL}	Refer to Fig. 3	---	100	180	ns
Pulse width distortion	Δ_{tw}	Refer to Fig. 3	-15	---	+15	ns

Fig. 1 Measuring Method of Optical Output Coupling with Fiber

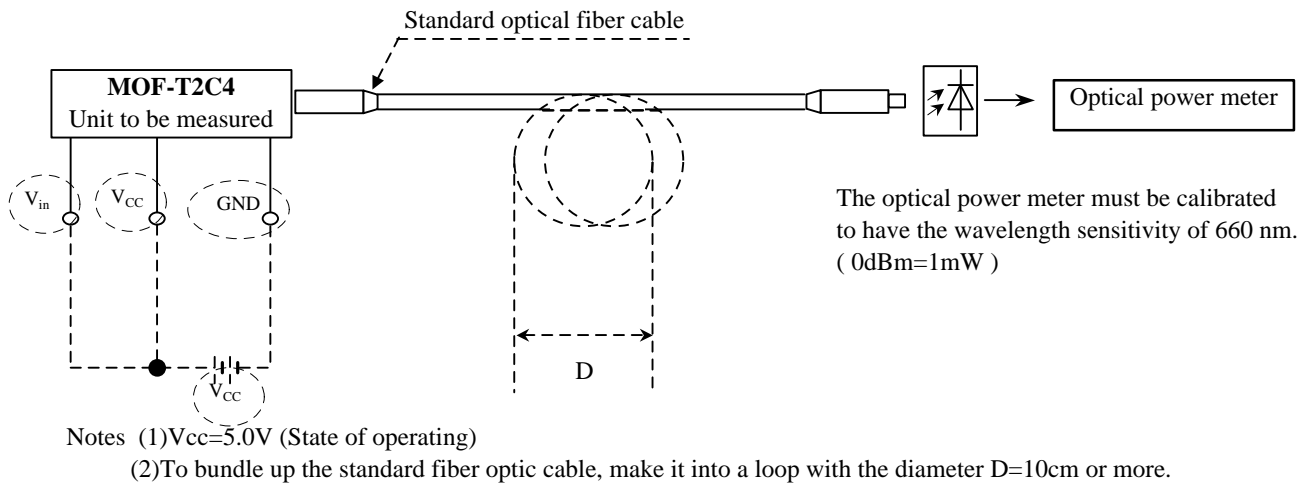
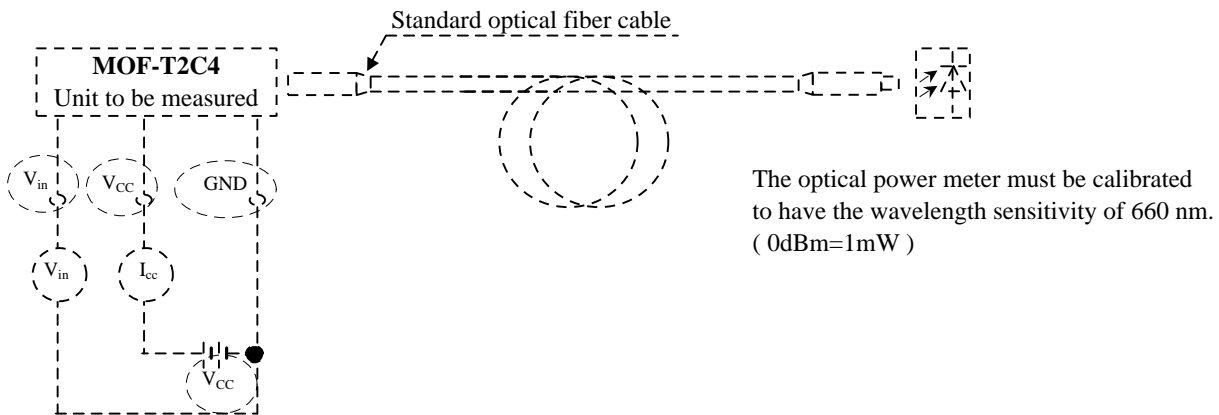

Fig. 2 Measuring Method of Input Voltage and Supply Current



Input conditions and judgement method

Conditions	Judgement method
$V_{in}=2.0V$ or more	$-21dBm \leq P_c \leq -15dBm$, $I_{cc}=13mA$ or less
$V_{in}=0.8V$ or less	$P_c \leq -36dBm$, $I_{cc}=13mA$ or less

Note: $V_{cc}=5.0V$ (State of operating)

Fig.3 Measuring Method of Pulse Response

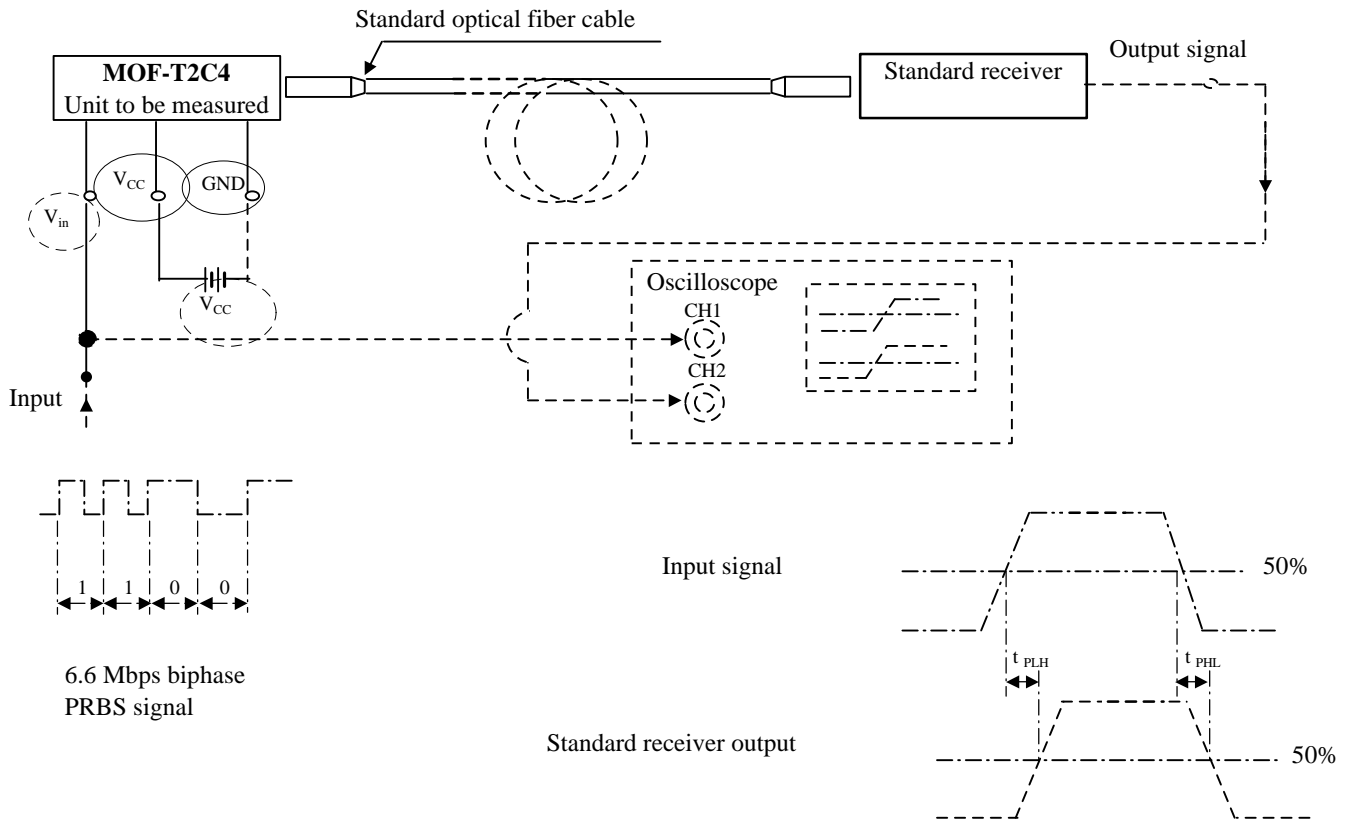

Test item

Test item	Symbol	Test condition
Low to High pulse delay time	t_{PLH}	Refer to the above prescriptions
High to Low pulse delay time	t_{PHL}	Refer to the above prescriptions
Pulse width distortion	Δtw	$\Delta tw = t_{PHL} - t_{PLH}$

- Notes (1) The waveform write time shall be 4 seconds. But do not allow the waveform to be distorted by increasing the brightness too much.
 (2) $V_{cc} = 5.0$ V (State of operating)
 (3) The probe for the oscilloscope must be more than 1M and less than 10pF.