

Product Features

- 50 ~ 4000 MHz
- 18dB Gain@900MHz
- 34.5dBm P1dB@900MHz
- 47dBm Output IP3
- GaAs HFET

Application

- CDMA, W-CDMA Medium Power Amplifier
- High Linearity Drive Amplifier
- ISM
- MMDS
- Wi-Fi, Wi-Max



Package : SP-12

Description

The RT230PD is designed for base stations and cell extenders and operating frequency range is from 50MHz to 4GHz. RT230PD is GaAs HFET in SP-12 type package which has superior performance against the heat at high temperature for its high reliability. It also has high efficiency, high gain and has a strong advantage using it as drive device at high frequency.

RT230PD is 100% RF&DC tested.

Absolute Maximum Ratings

Parameter	Symbol	Rating	Unit
Drain to Source Voltage	Vds	+12	V
Gate to Source Voltage Range	Vgs	0 to -5.0	V
Power Dissipation	Pt	7.5	W
Storage Temperature	Tstg	-65 to +175	°C
Channel Temperature	Tch	+175	°C

Electrical Characteristics

Parameter	Symbol	Min	Typ	Max	Unit
Saturated Drain Current	Idss		1100		mA
Transconductance	gm	-	790		mS
Pinch-off Voltage	Vp	-1	-1.8	-3	V
Breakdown Voltage Gate-Source	Bvgs	-18		-25	V
Breakdown Voltage Gate-Drain	Bvgd	-18		-25	V
Output Power @ 1dB G.C.P	P1dB	34	34.5		dBm
Power Gain @ 1dB G.C.P	G1dB		14.5		dB
Power added efficiency	η_{add}		50		%
Thermal Resistance	Rth		18	20	°C/W

* Test Conditions : $V_d=9V$, $I_d=450mA$, $T_a=+25^\circ C$, Frequency=2.3GHz

Electrical Specifications

Parameter	UNIT	Typical		
Frequency Range	MHz	900	1900	2600
Gain	dB	18	16.5	14.5
Input Return Loss	dB	-15	-20	-20
Output IP3	dBm	+47	+47	+47
1dB Compression Point	dBm	+34.5	+34.5	+34
Channel Power	dBm	27.5	25.5	
Noise Figure	dB	2.5	2.5	3.0
DC Current	mA	450	450	450
Supply Voltage	VDC	+9	+9	+9

*Test Conditions : ($V_d = +9V$, $I_d = 450mA$, $T_a = +25^\circ C$)

*OIP3 is measured with two tones, at an output power of 20dBm/tone separated by 1MHz

Application Circuit for RT230PD(824 ~ 896MHz)

Performance Charts ($V_d = +9V$, $I_d = 450mA$, $T_a = 25^\circ C$)

Typical Specifications				
Frequency Range	MHz	824	860	896
Gain	dB	18.5	18.3	18
Input Return Loss	dB	-15	-20	-16
Output P1dB	dBm		34.5	
Output IP3	dBm		47	
Noise Figure	dB		2.5	
Channel Power@-45dBc ACPR	dBm		27.5	

Application Circuit

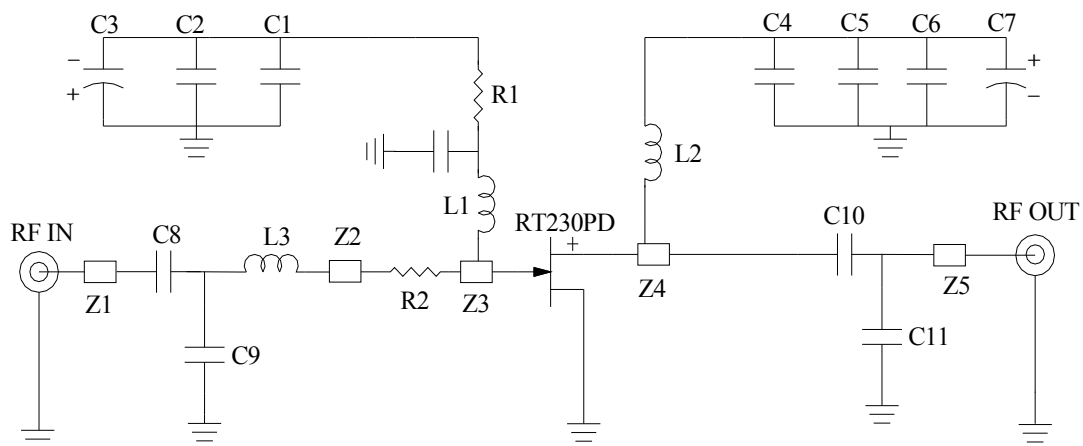

Bill of Material					
Text	Value	Size(mm)	Text	Value	Size(mm)
C4	100pF	1608	L1	18nH	1608
C1,C5	1000pF	1608	L2	18nH	2520
C2,C6	0.1uF	1608	L3	3.9nH	1608
C3,C7	4.7uF	3216	Z1	W x L	1.4 x 2.0
C8,C10	30pF	1608	Z2		1.4 x 1.5
C9	5pF	1608	Z3		1.4 x 2.0
C11	4pF	1608	Z4		1.4 x 6.0
R1	51 Ω	1608	Z5		1.4 x 3.0
R2	8.2 Ω	1608	Circuit Board Material : FR4($\epsilon_r=4.7$), 0.8mm		

Power Transistor

RT230PD

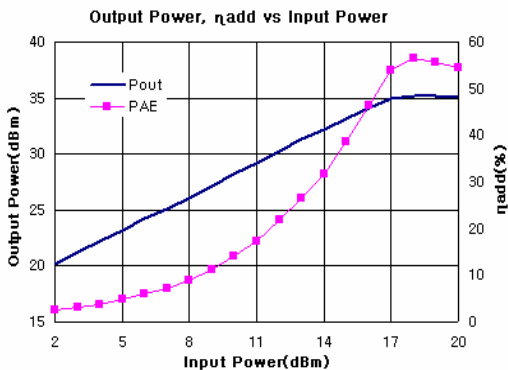
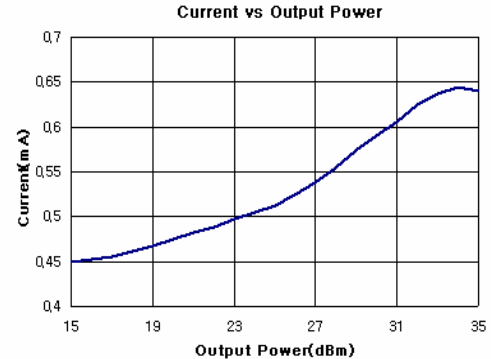
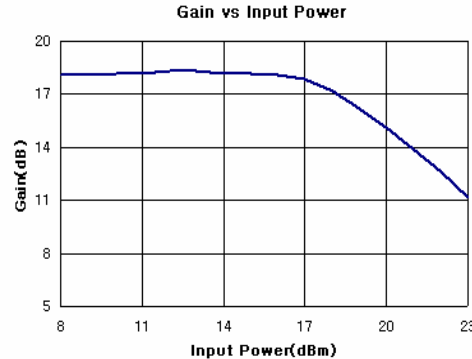
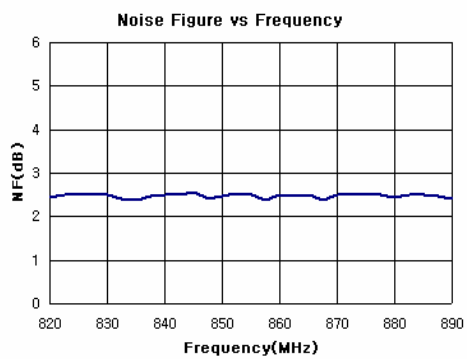
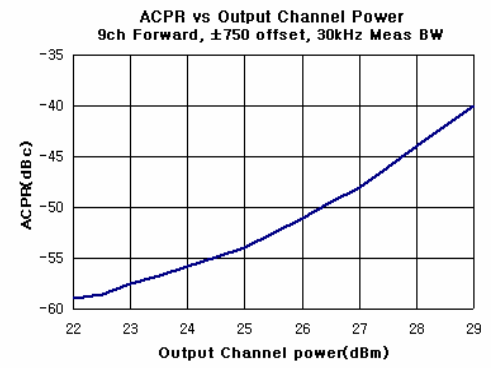
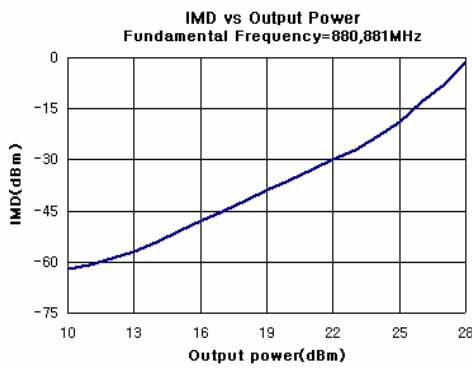
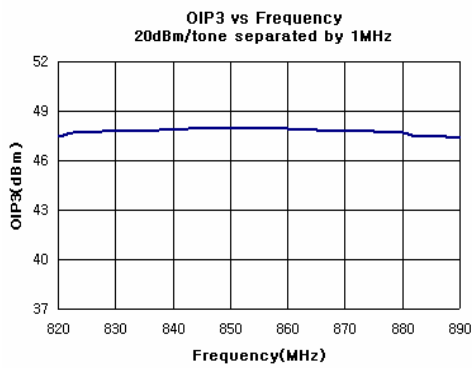
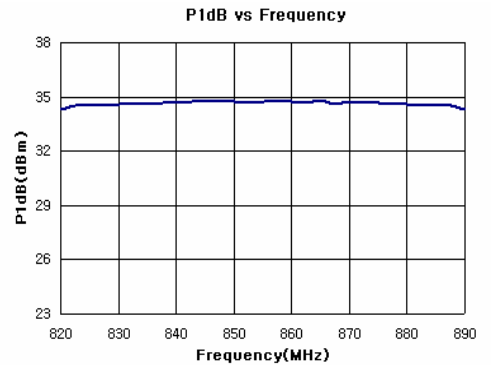
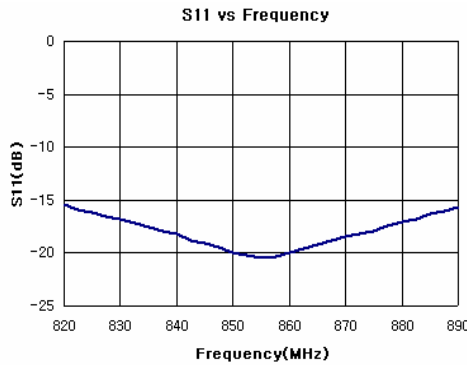
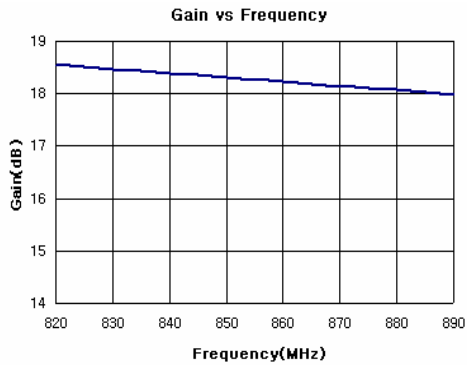

Application Circuit for RT230PD(890 ~ 960MHz)

Performance Charts ($V_d = +9V$, $I_d = 450mA$, $T_a = 25^\circ C$)

Typical Specifications				
Frequency Range	MHz	890	925	960
Gain	dB	18.2	18	17.8
Input Return Loss	dB	-14	-18	-16
Output P1dB	dBm		34.5	
Output IP3	dBm		47	
Noise Figure	dB		2.5	
Channel Power@-45dBc ACPR	dBm		27.5	

Application Circuit (890 ~ 960MHz)

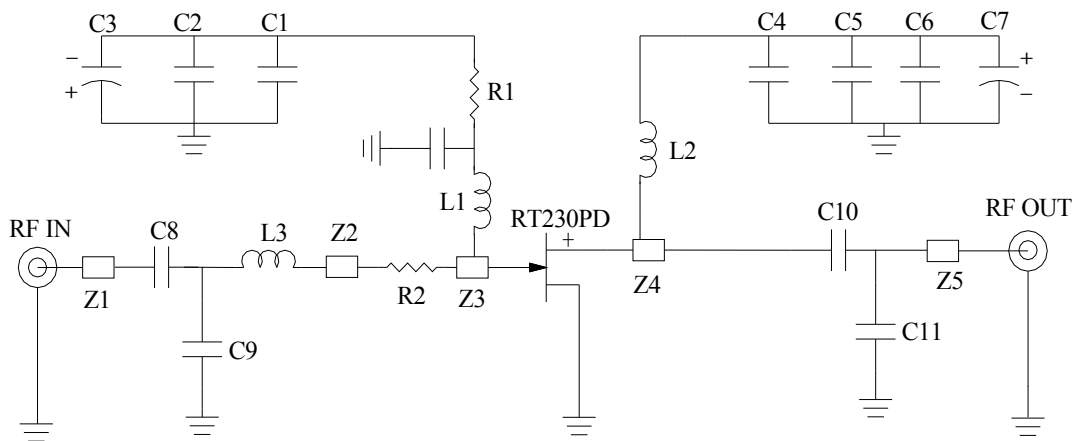

Bill of Material					
Text	Value	Size(mm)	Text	Value	Size(mm)
C4	100pF	1608	L1	18nH	1608
C1,C5	1000pF	1608	L2	18nH	2520
C2,C6	0.1uF	1608	L3	3.3nH	1608
C3,C7	4.7uF	3216	Z1	W x L	1.4 x 2.0
C8,C10	30pF	1608	Z2		1.4 x 1.5
C9	5pF	1608	Z3		1.4 x 2.0
C11	4pF	1608	Z4		1.4 x 6.0
R1	51 Ω	1608	Z5		1.4 x 3.0
R2	8.2 Ω	1608	Circuit Board Material : FR4($\epsilon_r=4.7$), 0.8mm		

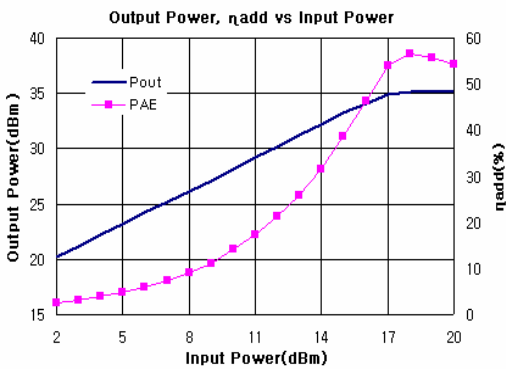
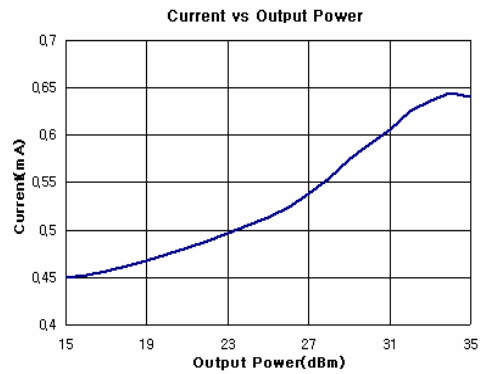
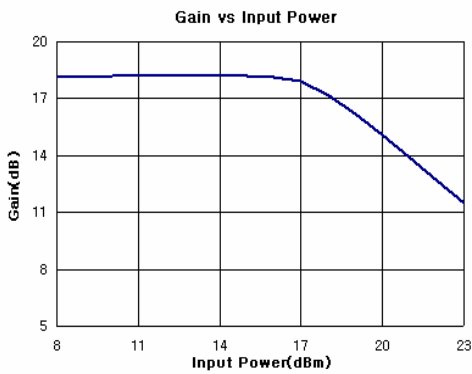
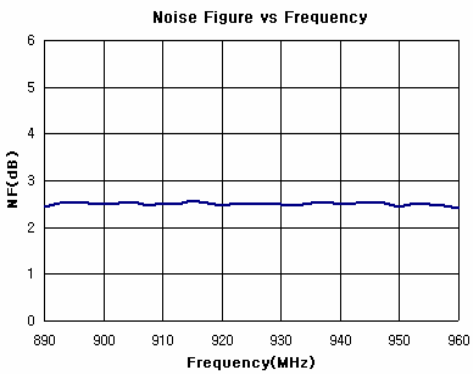
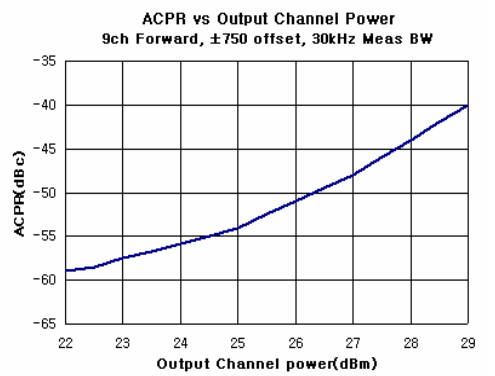
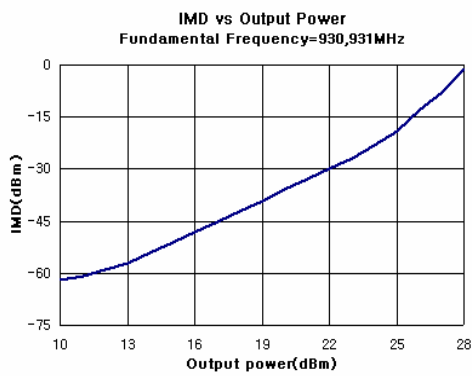
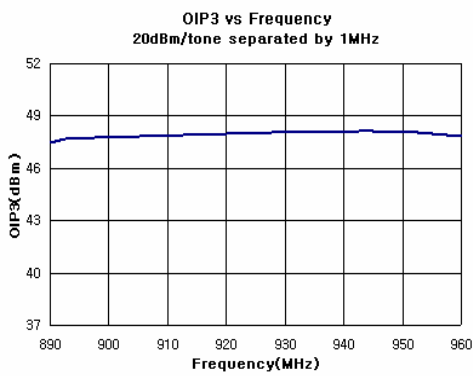
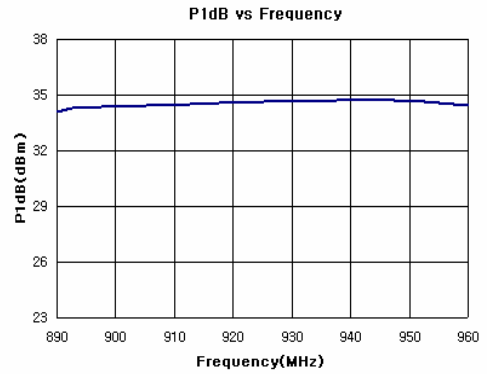
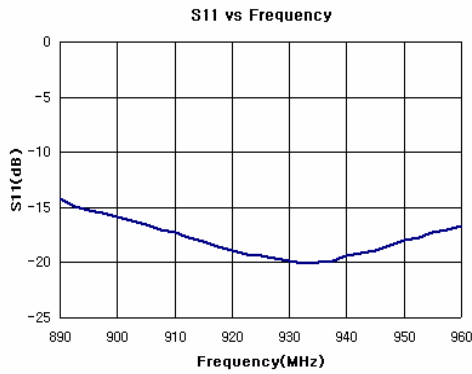
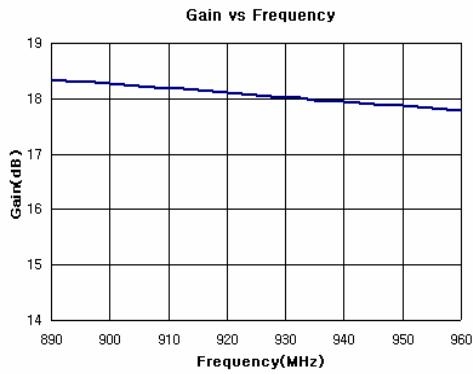

Application Circuit for RT230PD(1700 ~ 1800MHz)

Performance Charts ($V_d=9V$, $I_d=450mA$, $T_a=25^\circ C$)

Typical Specifications				
Frequency Range	MHz	1700	1750	1800
Gain	dB	16.8	17.3	16.5
Input Return Loss	dB	-13	-17	-11
Output P1dB	dBm		34.5	
Output IP3	dBm		47	
Noise Figure	dB		2.5	
Channel Power@ -45dBc ACPR	dBm		27.5	

Application Circuit (1700 ~ 1800MHz)

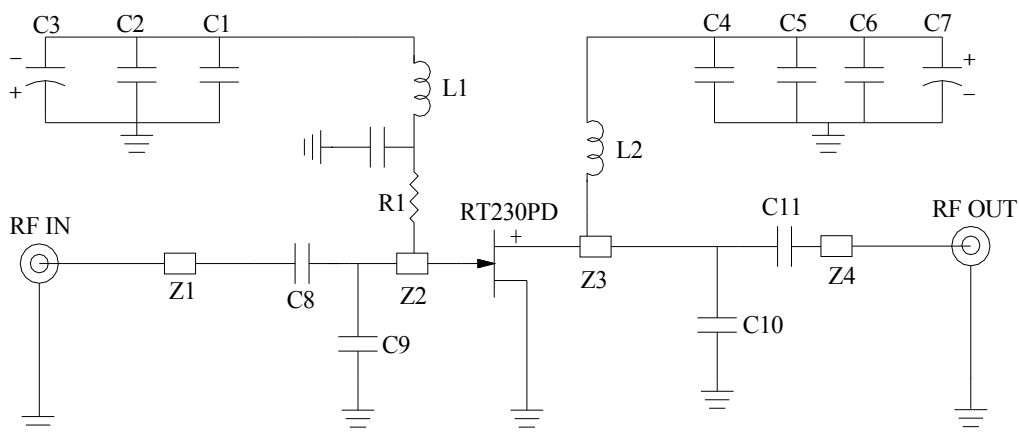

Bill of Material					
Text	Value	Size(mm)	Text	Value	Size(mm)
C4	100pF	1608	R1	51 Ω	1608
C1,C5	1000pF	1608	L1	18nH	1608
C2,C6	0.1uF	1608	L2	18nH	2520
C3,C7	4.7uF	3216	Z1	W x L	1.4 x 7.0
C8	10pF	1608	Z2		1.4 x 2.0
C9	3.6pF	1608	Z3		1.4 x 2.0
C10	1.5pF	1608	Z4		1.4 x 7.0
C11	5pF	1608	Circuit Board Material : FR4($\epsilon_r=4.7$), 0.8mm		

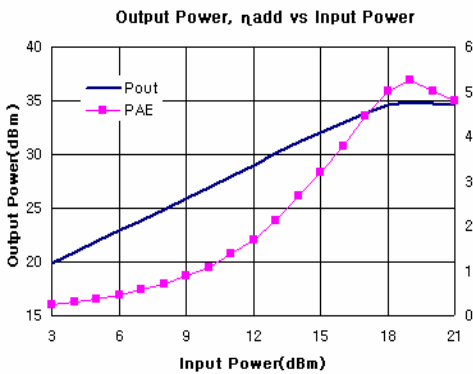
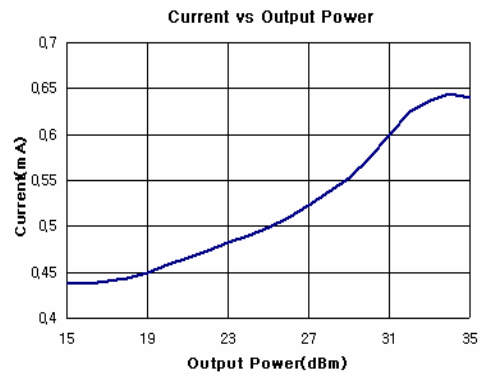
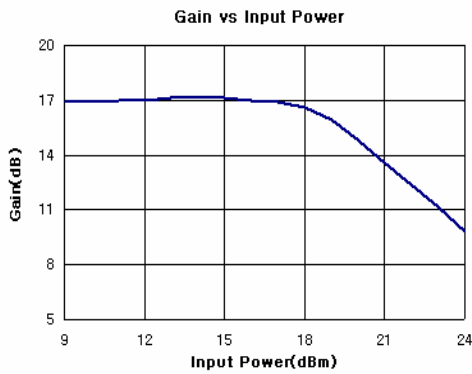
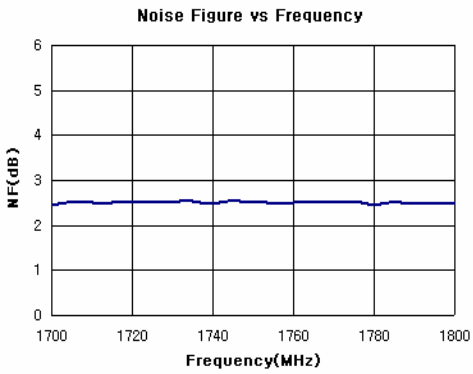
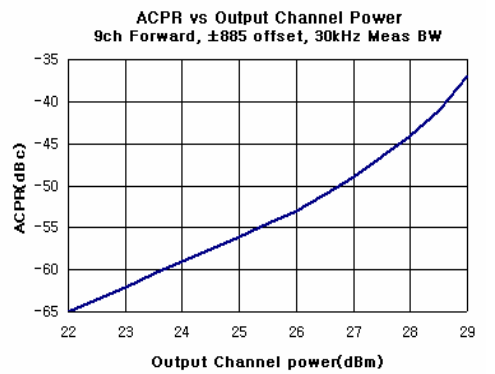
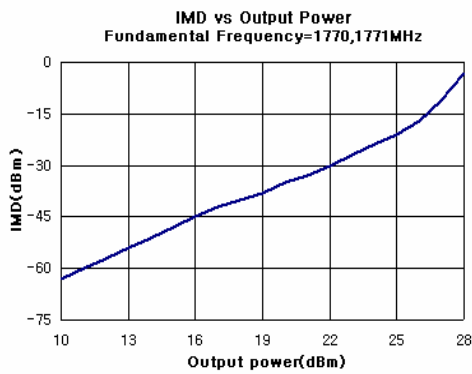
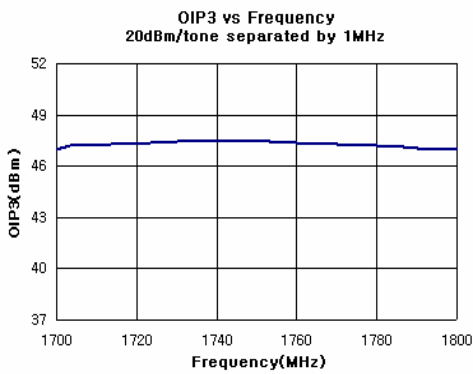
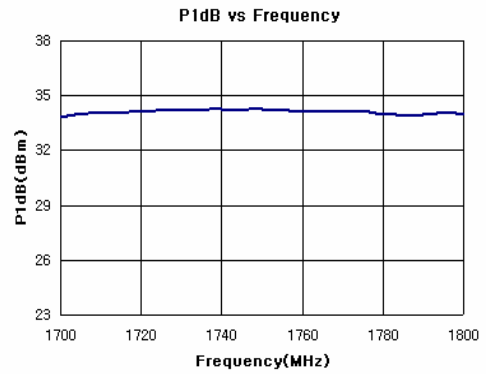
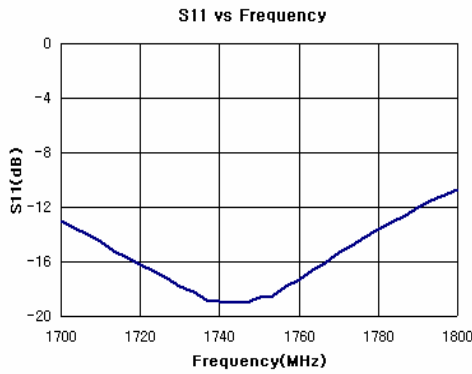
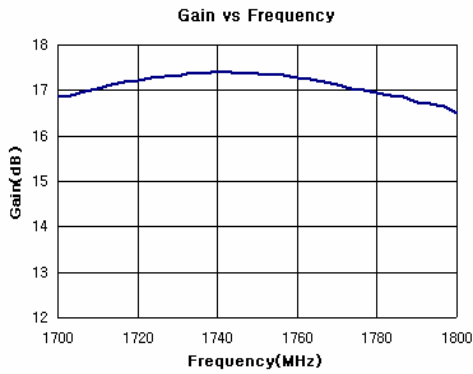

Application Circuit for RT230PD(1800 ~ 1900MHz)

Performance Charts ($V_d=9V$, $I_d=450mA$, $T_a=25^\circ C$)

Typical Specifications				
Frequency Range	MHz	1700	1750	1800
Gain	dB	16.9	17	16.6
Input Return Loss	dB	-10	-22	-13
Output P1dB	dBm		34.5	
Output IP3	dBm		47	
Noise Figure	dB		2.5	
Channel Power@ -45dBc ACPR	dBm		27.5	

Application Circuit (1800 ~ 1900MHz)

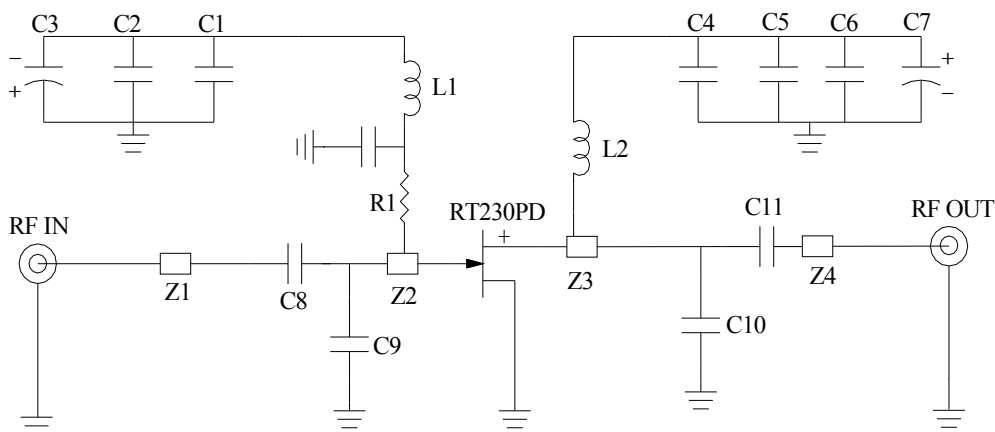

Bill of Material					
Text	Value	Size(mm)	Text	Value	Size(mm)
C4	100pF	1608	R1	51 Ω	1608
C1,C5	1000pF	1608	L1	18nH	1608
C2,C6	0.1uF	1608	L2	18nH	2520
C3,C7	4.7uF	3216	Z1	W x L	1.4 x 7.0
C8	10pF	1608	Z2		1.4 x 2.0
C9	3.0pF	1608	Z3		1.4 x 2.0
C10	1.5pF	1608	Z4		1.4 x 7.0
C11	5pF	1608	Circuit Board Material : FR4($\epsilon_r=4.7$), 0.8mm		

Gain vs Frequency

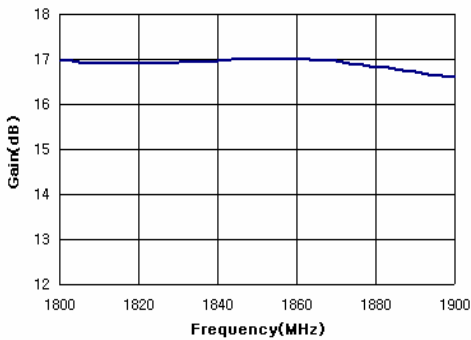

S11 vs Frequency

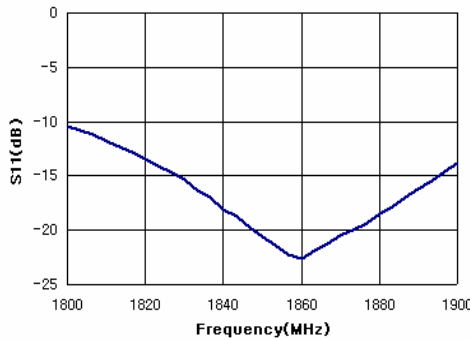

P1dB vs Frequency

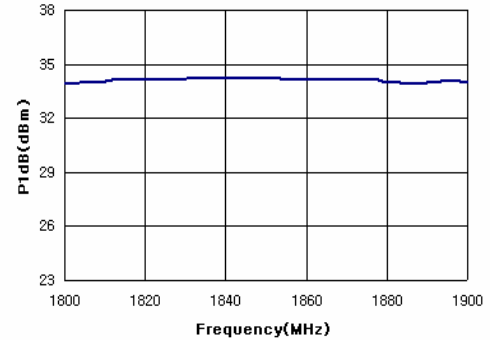

OIP3 vs Frequency
20dBm/tone separated by 1MHz

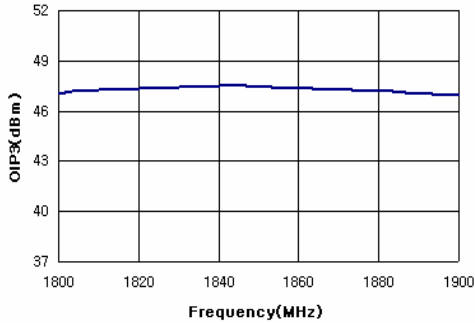

IMD vs Output Power
Fundamental Frequency=1860,1861MHz

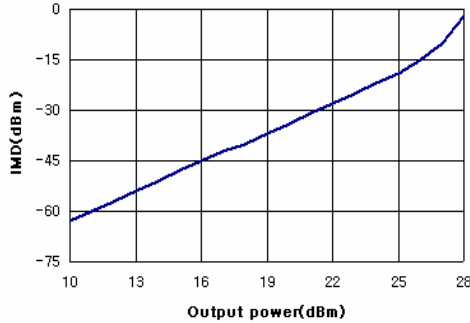

ACPR vs Output Channel Power
9ch Forward, ±885 offset, 30kHz Meas BW

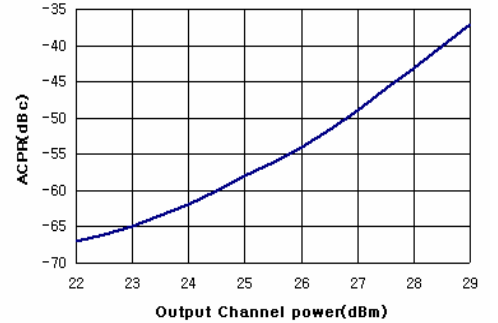

Noise Figure vs Frequency

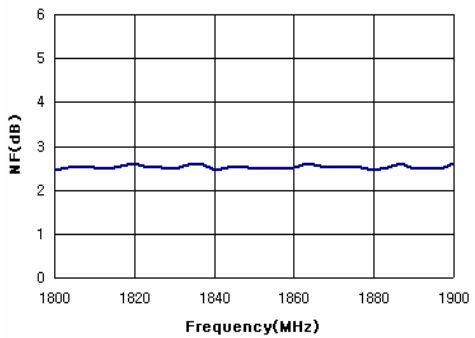

Gain vs Input Power

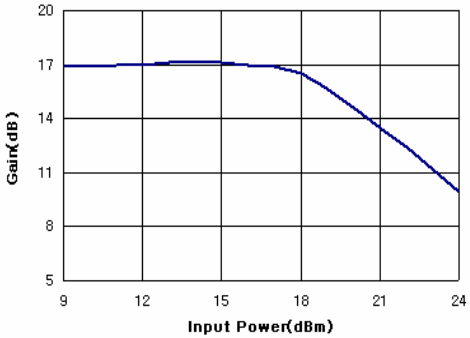

Current vs Output Power

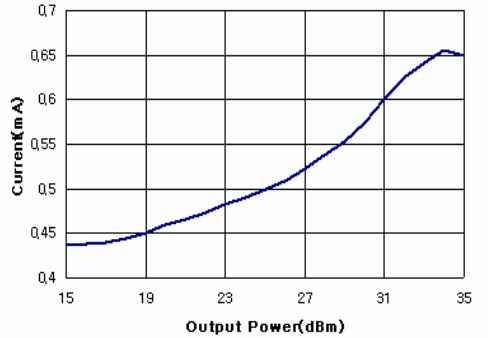

Output Power, η_{add} vs Input Power

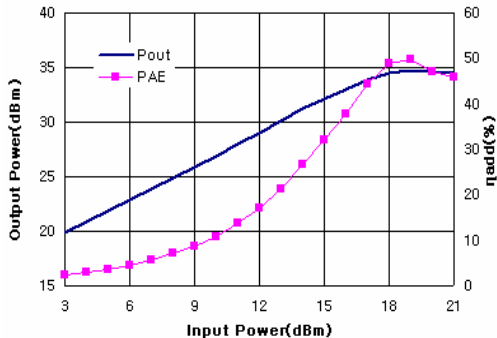

Application Circuit for RT230PD(1900 ~ 2000MHz)

Performance Charts ($V_d=9V$, $I_d=450mA$, $T_a=25^\circ C$)

Typical Specifications				
Frequency Range	MHz	1900	1950	2000
Gain	dB	16.5	16.7	15.9
Input Return Loss	dB	-15	-24	-12
Output P1dB	dBm		34.5	
Output IP3	dBm		47	
Noise Figure	dB		2.5	
Channel Power@ -45dBc ACLR	dBm		25	

Application Circuit (1900 ~ 2000MHz)

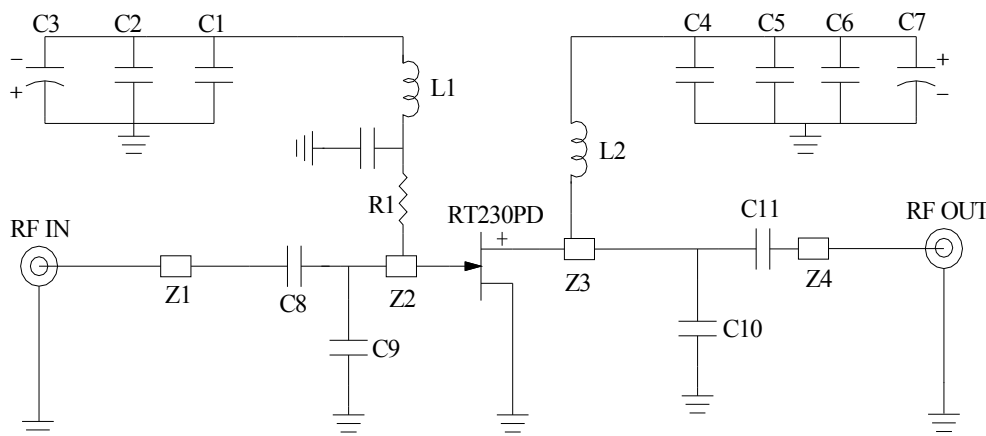

Bill of Material					
Text	Value	Size(mm)	Text	Value	Size(mm)
C4	100pF	1608	R1	51 Ω	1608
C1,C5	1000pF	1608	L1	18nH	1608
C2,C6	0.1uF	1608	L2	18nH	2520
C3,C7	4.7uF	3216	Z1	W x L	1.4 x 7.0
C8	10pF	1608	Z2		1.4 x 2.0
C9	2.7pF	1608	Z3		1.4 x 2.0
C10	1.5pF	1608	Z4		1.4 x 7.0
C11	5pF	1608	Circuit Board Material : FR4($\epsilon_r=4.7$), 0.8mm		

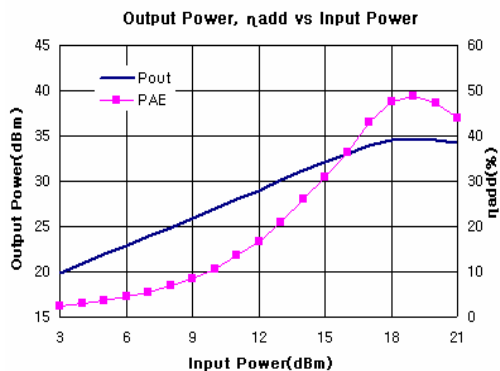
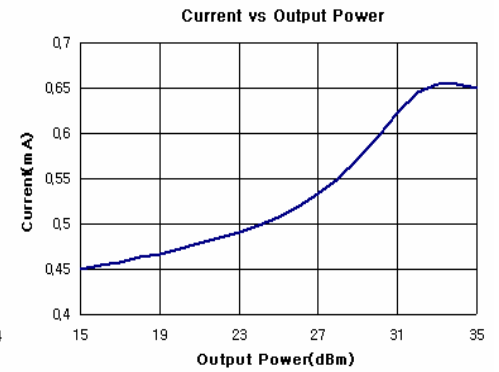
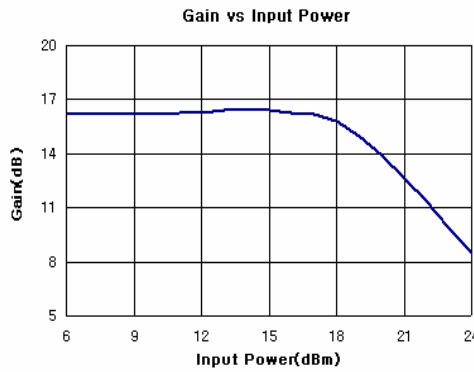
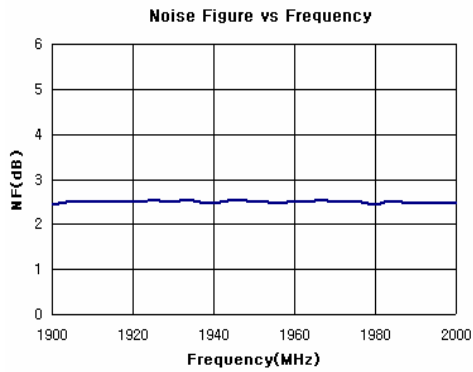
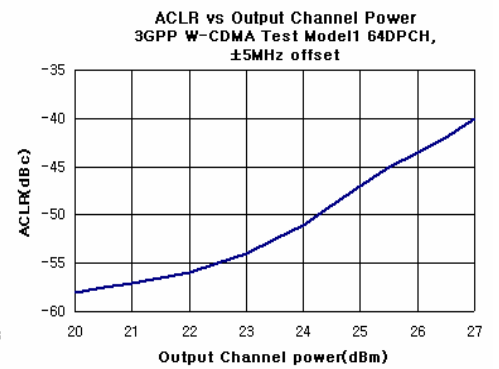
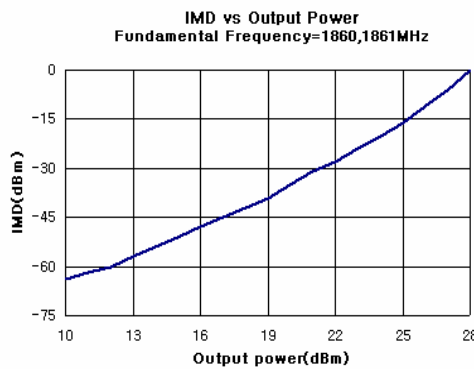
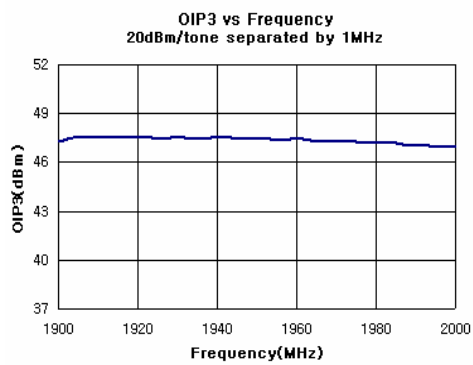
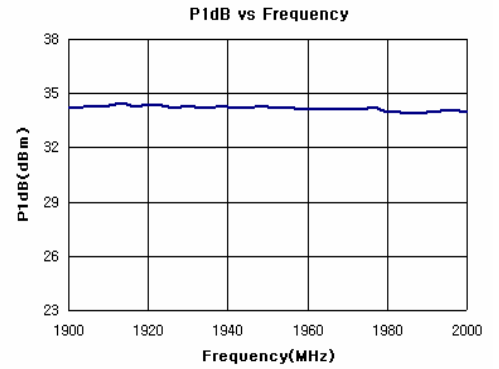
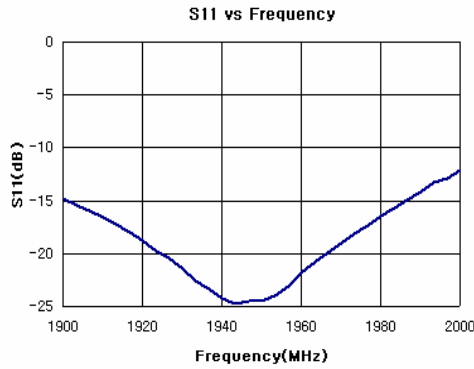
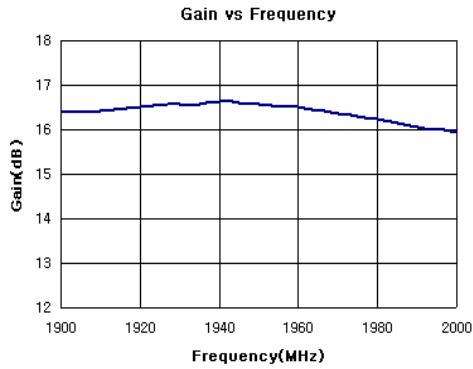

Application Circuit for RT230PD(2100 ~ 2200MHz)

Performance Charts ($V_d=9V$, $I_d=450mA$, $T_a=25^\circ C$)

Typical Specifications				
Frequency Range	MHz	2100	2150	2200
Gain	dB	16.5	16.3	16.2
Input Return Loss	dB	-13	-15	-14
Output P1dB	dBm		34.5	
Output IP3	dBm		47	
Noise Figure	dB		2.5	
Channel Power @ -45dBc ACLR	dBm		25	

Application Circuit (2100 ~ 2200MHz)

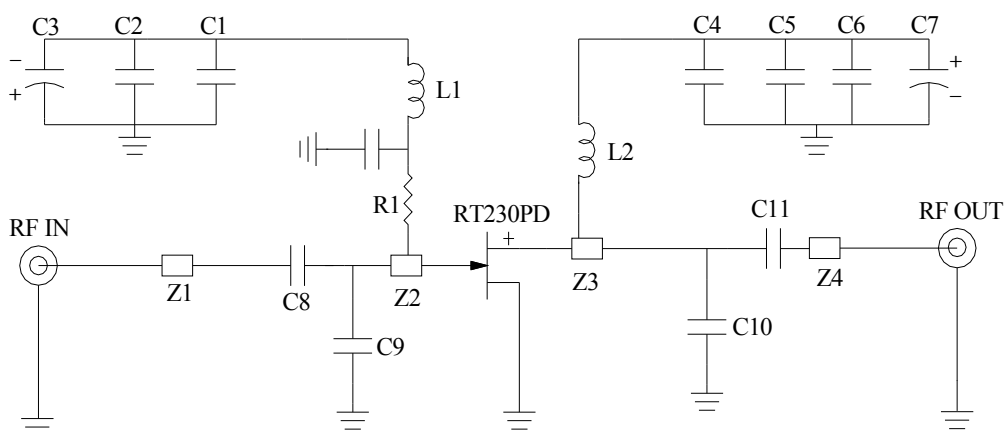

Bill of Material					
Text	Value	Size(mm)	Text	Value	Size(mm)
C4	100pF	1608	R1	51 Ω	1608
C1,C5	1000pF	1608	L1	18nH	1608
C2,C6	0.1uF	1608	L2	18nH	2520
C3,C7	4.7uF	3216	Z1	W x L	1.4 x 7.0
C8	10pF	1608	Z2		1.4 x 2.0
C9	2.4pF	1608	Z3		1.4 x 2.0
C10	1.5pF	1608	Z4		1.4 x 7.0
C11	5pF	1608	Circuit Board Material : FR4($\epsilon_r=4.7$), 0.8mm		

Power Transistor

RT230PD

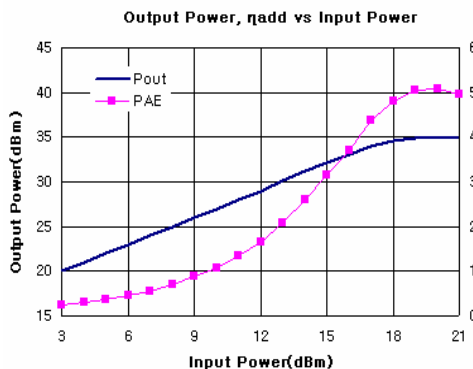
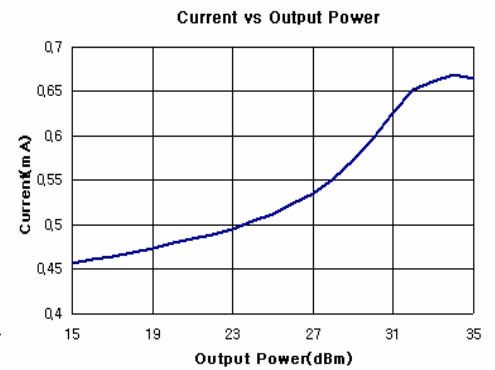
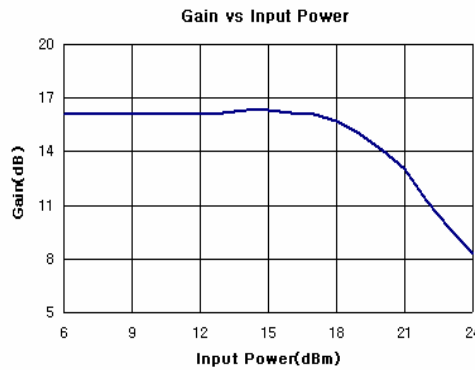
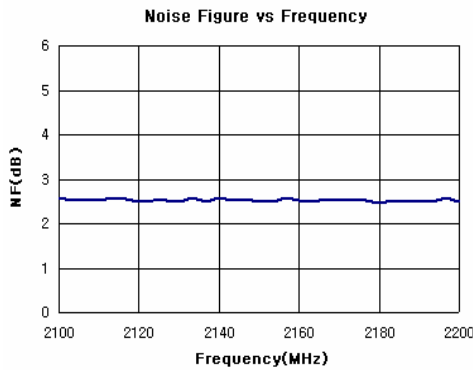
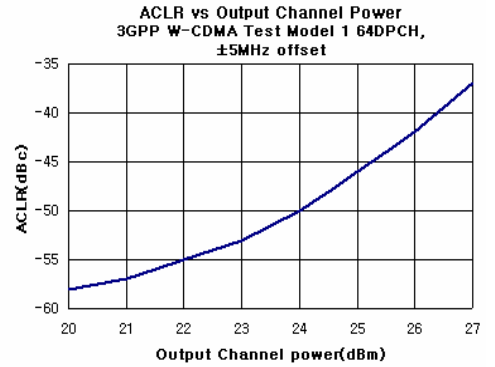
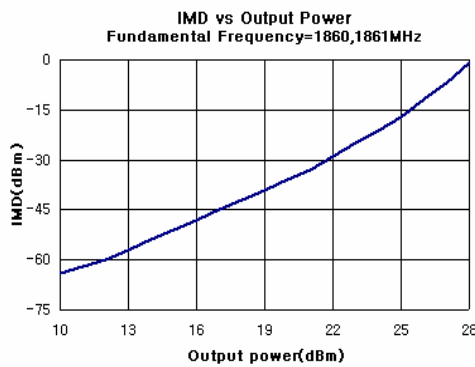
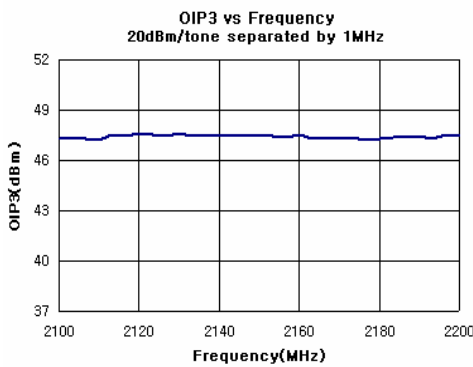
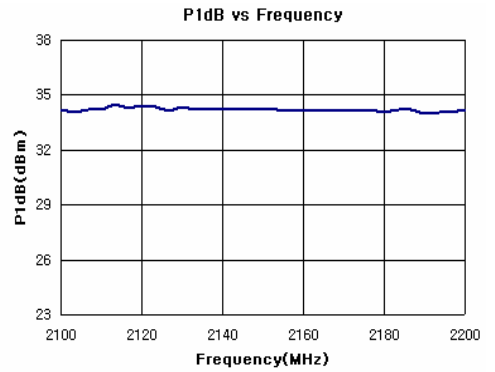
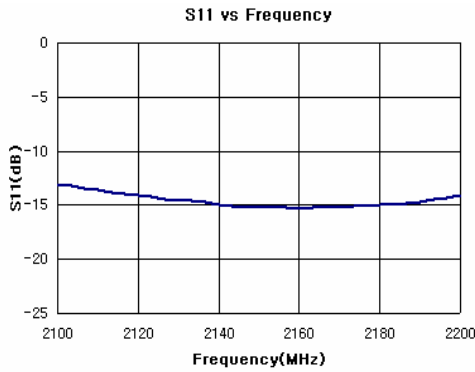
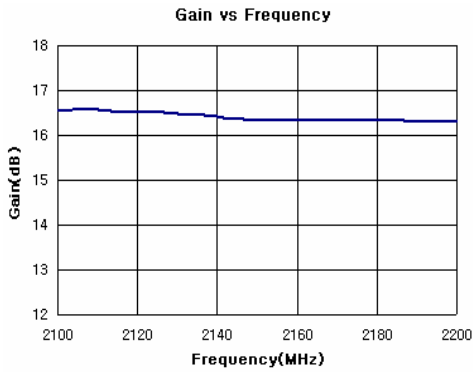

Application Circuit for RT230PD(2300 ~ 2400MHz)

Performance Charts ($V_d=9V$, $I_d=450mA$, $T_a=25^\circ C$)

Typical Specifications				
Frequency Range	MHz	2300	2350	2400
Gain	dB	15.2	15.5	15
Input Return Loss	dB	-10	-20	-10
Output P1dB	dBm		34.5	
Output IP3	dBm		47	
Noise Figure	dB		2.8	

Application Circuit (2300 ~ 2400MHz)

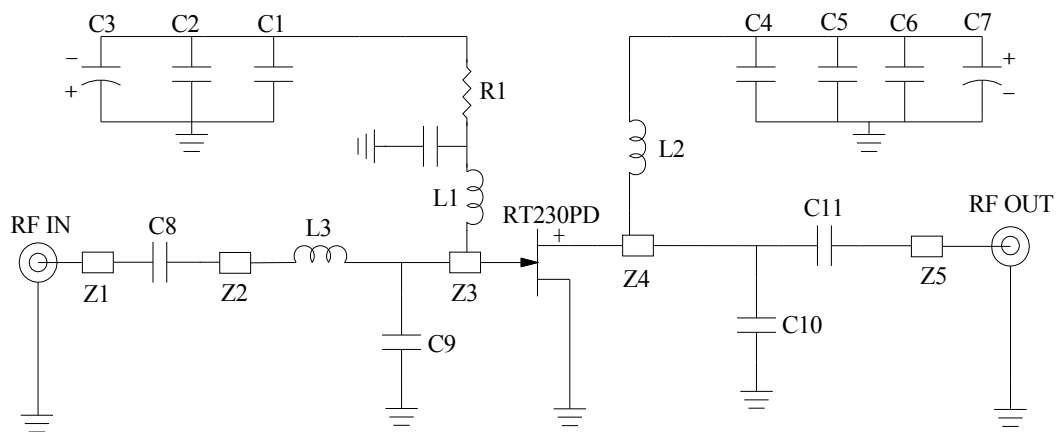

Bill of Material					
Text	Value	Size(mm)	Text	Value	Size(mm)
C4	100pF	1608	L1	18nH	1608
C1,C5	1000pF	1608	L2	18nH	2520
C2,C6	0.1uF	1608	L3	2.7nH	1608
C3,C7	4.7uF	3216	Z1	W x L	1.4 x 1.0
C8	10pF	1608	Z2		1.4 x 4.0
C9	2.2pF	1608	Z3		1.4 x 1.0
C10	1.5pF	1608	Z4		1.4 x 1.0
C11	5pF	1608	Z5		1.4 x 7.0
R1	51 Ω	1608	Circuit Board Material : FR4($\epsilon_r=4.7$), 0.8mm		

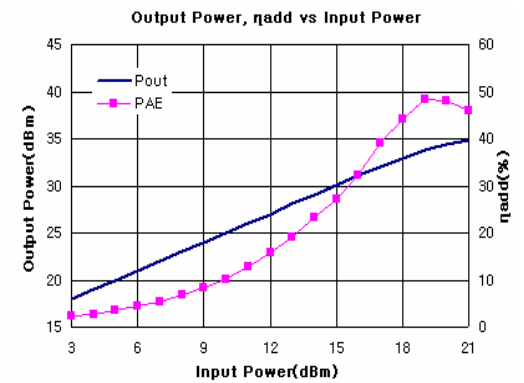
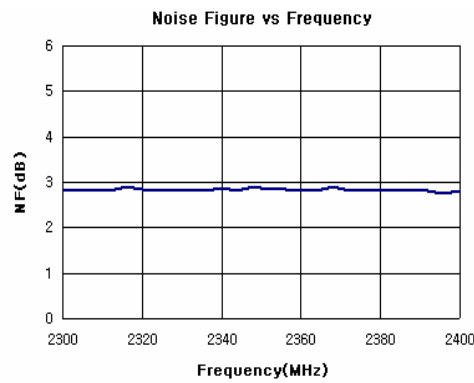
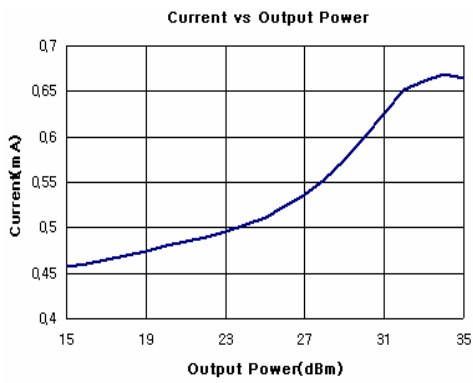
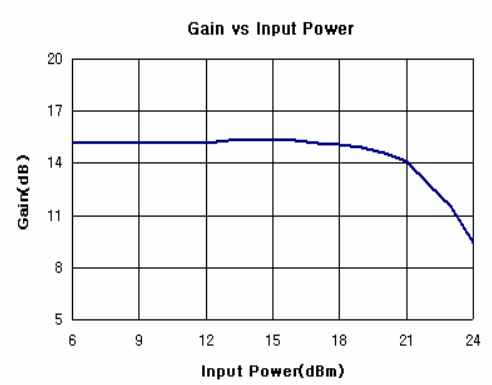
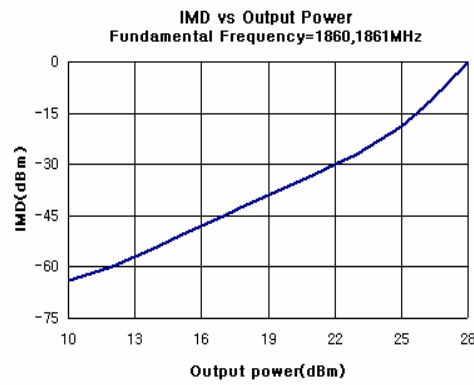
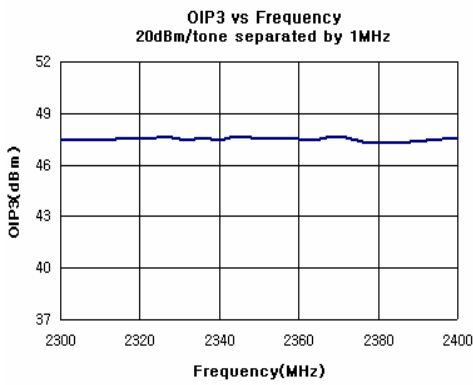
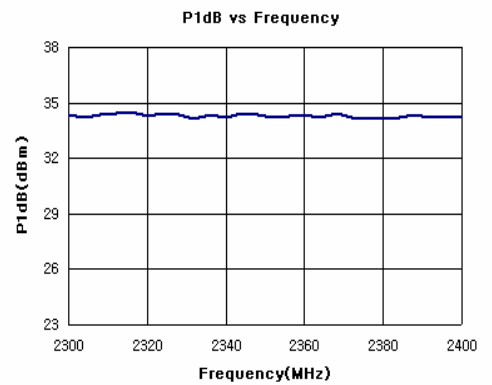
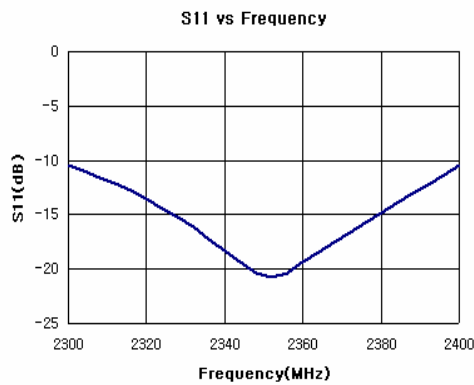
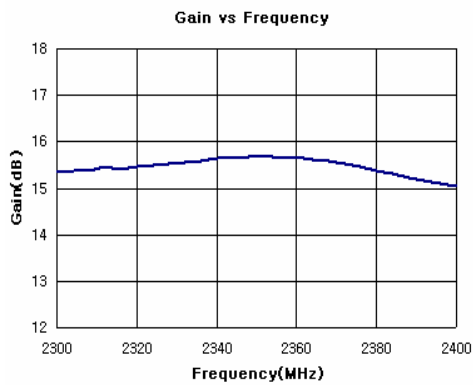

Application Circuit for RT230PD(2500 ~ 2700MHz)

Performance Charts ($V_d=9V$, $I_d=450mA$, $T_a=25^\circ C$)

Typical Specifications				
Frequency Range	MHz	2500	2600	2700
Gain	dB	14.7	14.7	14.2
Input Return Loss	dB	-7	-25	-7
Output P1dB	dBm		34	
Output IP3	dBm		47	
Noise Figure	dB		3.0	

Application Circuit (2500 ~ 2700MHz)

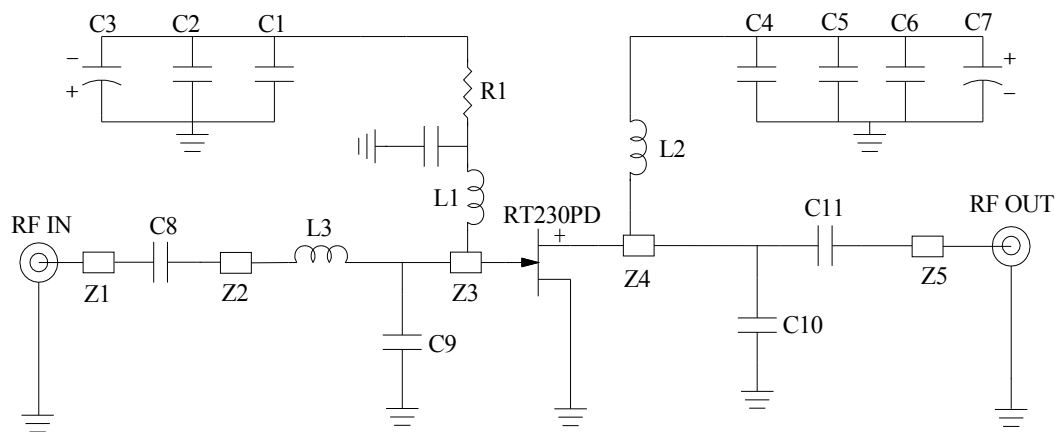

Bill of Material					
Text	Value	Size(mm)	Text	Value	Size(mm)
C4	100pF	1608	L1	18nH	1608
C1,C5	1000pF	1608	L2	18nH	2520
C2,C6	0.1uF	1608	L3	2.7nH	1608
C3,C7	4.7uF	3216	Z1	W x L	1.4 x 1.0
C8	10pF	1608	Z2		1.4 x 4.0
C9	1.8pF	1608	Z3		1.4 x 1.0
C10	1.5pF	1608	Z4		1.4 x 1.0
C11	5pF	1608	Z5		1.4 x 7.0
R1	51 Ω	1608	Circuit Board Material : FR4($\epsilon_r=4.7$), 0.8mm		

Power Transistor

RT230PD

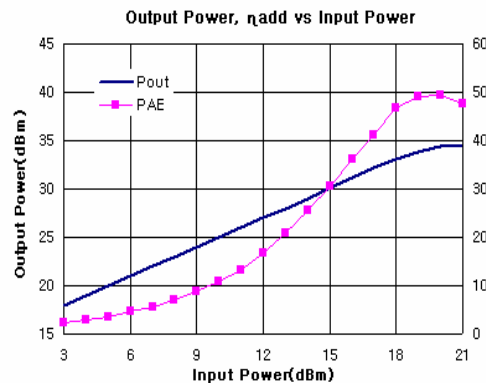
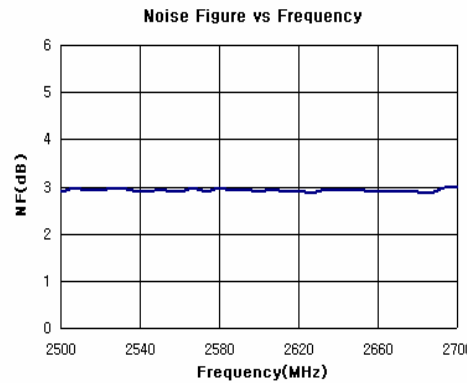
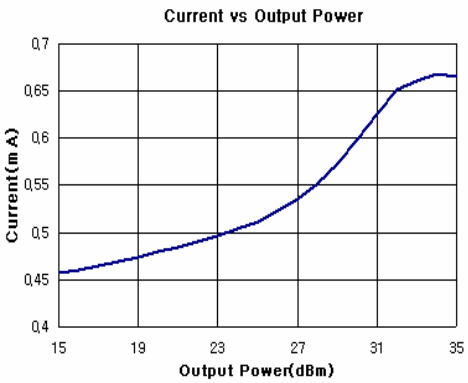
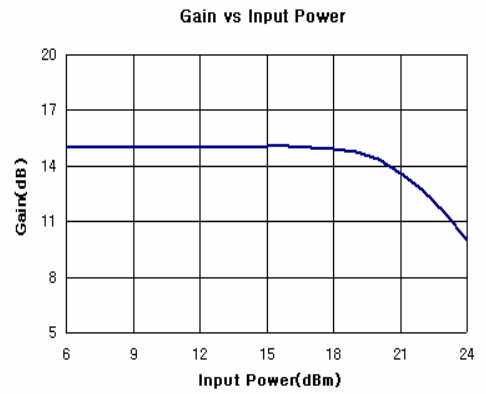
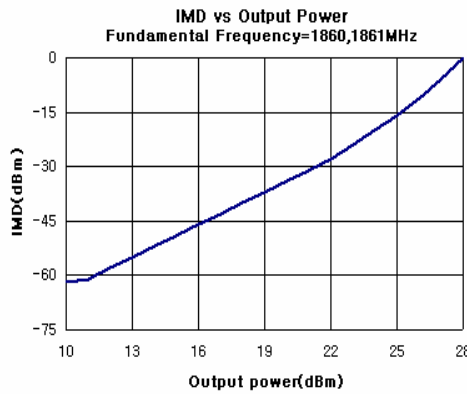
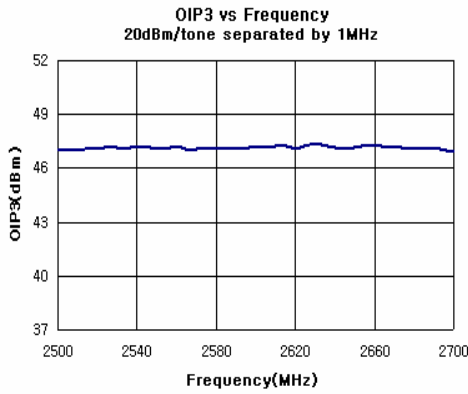
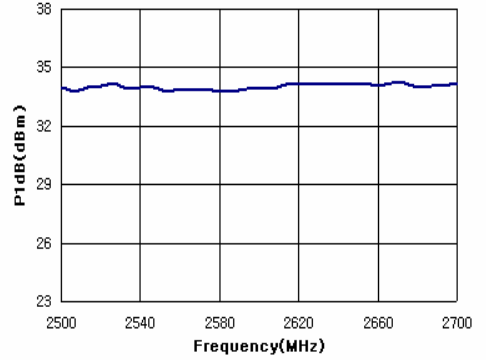
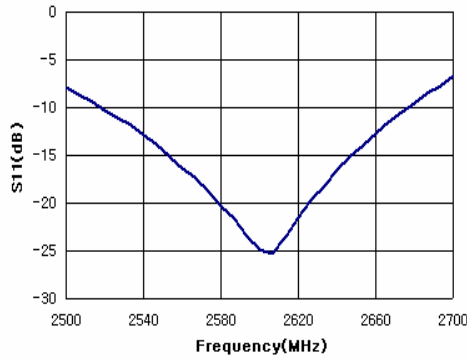
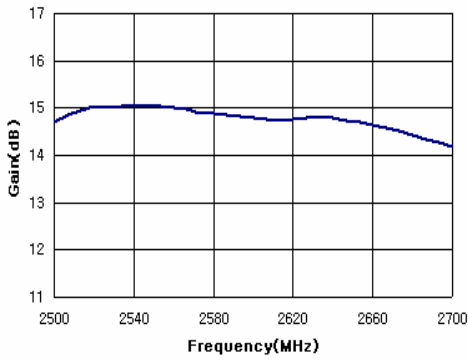

Application Circuit for RT230PD(3400 ~ 3600MHz)

Performance Charts ($V_d=9V$, $I_d=450mA$, $T_a=25^\circ C$)

Typical Specifications				
Frequency Range	MHz	3400	3500	3600
Gain	dB	11.9	12	11.9
Input Return Loss	dB	-7	-10	-7
Output P1dB	dBm		33	
Output IP3	dBm		46	
Noise Figure	dB		3.5	

Application Circuit (3400 ~ 3600MHz)

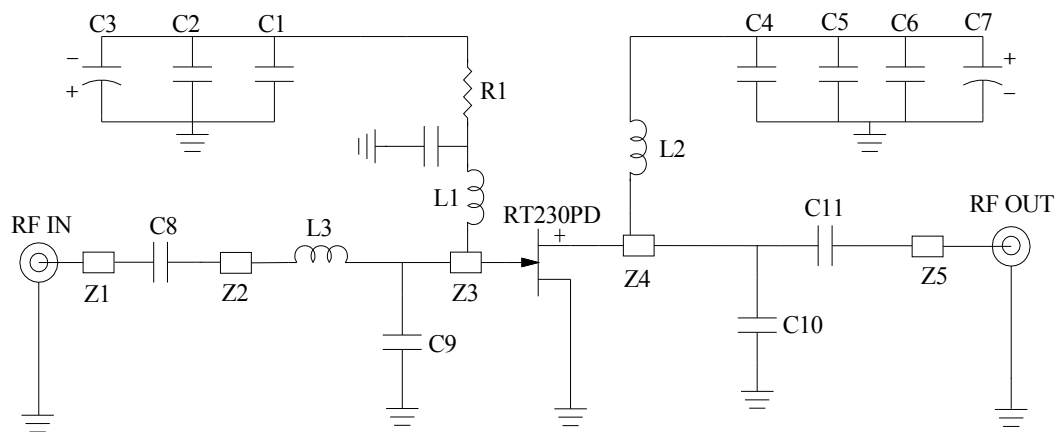

Bill of Material					
Text	Value	Size(mm)	Text	Value	Size(mm)
C4	100pF	1608	L1	18nH	1608
C1,C5	1000pF	1608	L2	18nH	2520
C2,C6	0.1uF	1608	L3	1.5nH	1608
C3,C7	4.7uF	3216	Z1	W x L	1.4 x 1.0
C8	5pF	1608	Z2		1.4 x 4.0
C9	1.0pF	1608	Z3		1.4 x 1.0
C10	0.5pF	1608	Z4		1.4 x 1.0
C11	4pF	1608	Z5		1.4 x 7.0
R1	51 Ω	1608	Circuit Board Material : FR4($\epsilon_r=4.7$), 0.8mm		

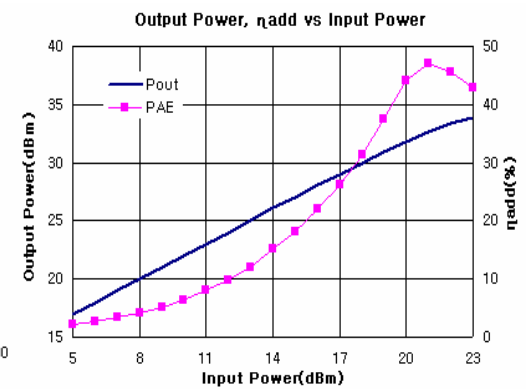
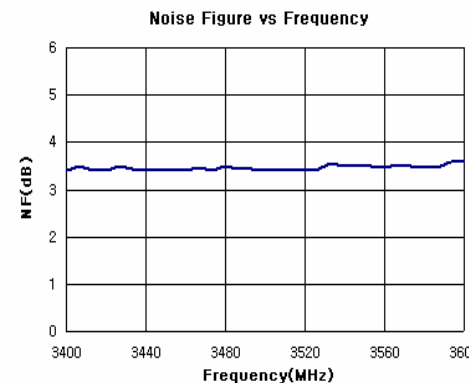
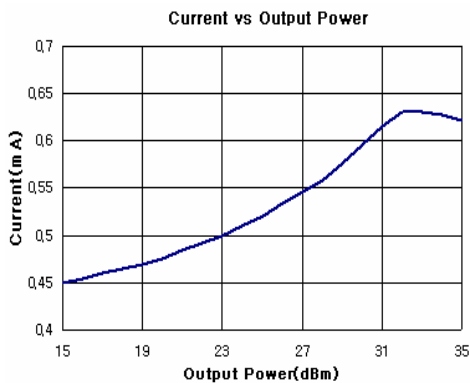
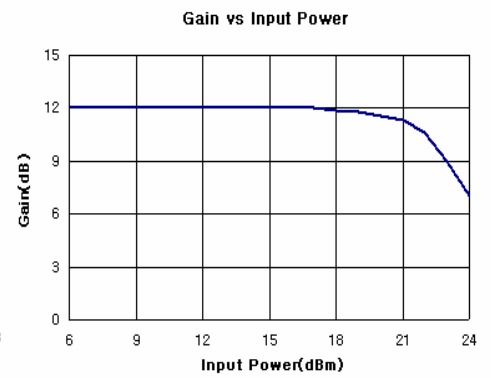
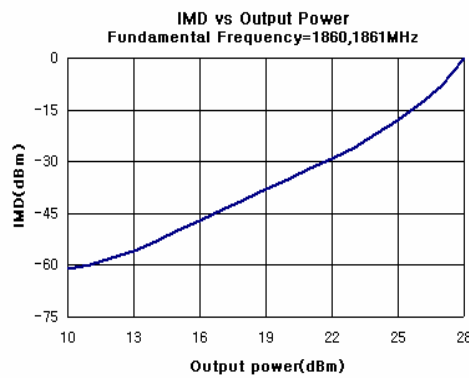
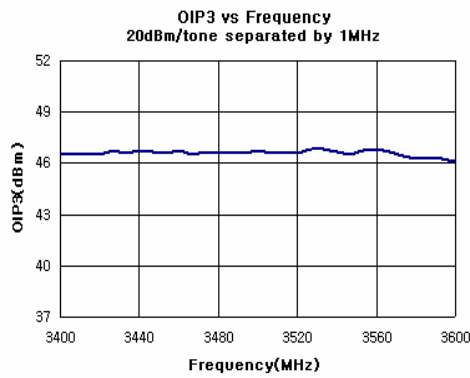
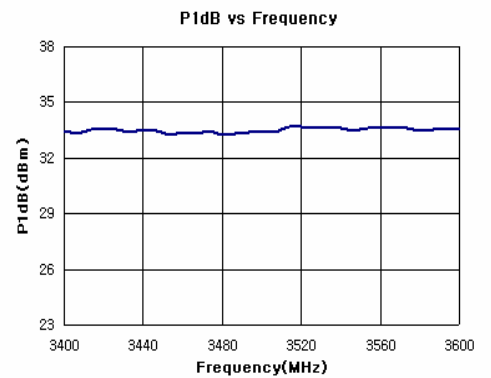
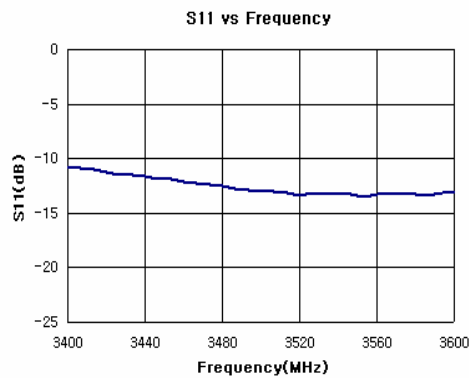
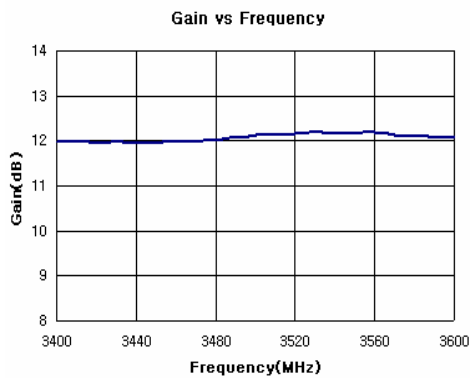

Biasing Circuits for GaAs HFET Power Amplifiers

This circuit below normally operates GaAs Power Amplifier and it is one of the circuits for stable operation and satisfactory performance. It is structured by the parts for constant current operation.

Main functions of this circuit :

Negative Voltage Generator

Power Sequencing mode(Negative before positive)

Constant operating current

Constant operating current circuit is structured by low cost components. It will operate of constant current regardless of any temperature changes. R3 should carefully be taken by power dissipation.

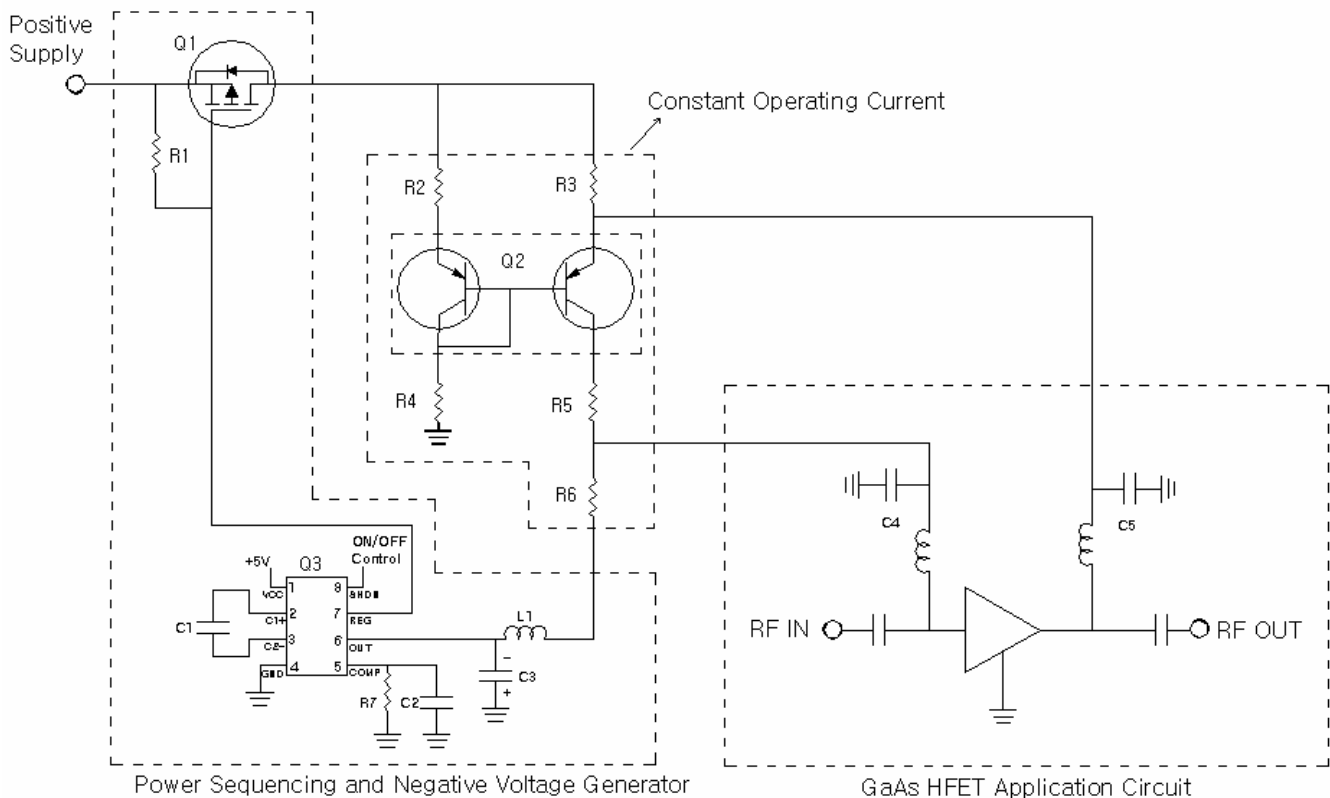

PN	Value	Description	Maker	Quantity
Q1	N/A	P-channel MOSFET, IRLML5203	IRF	1
Q2	N/A	Dual PNP, UMT1N	Rohm	1
Q3	N/A	DC-DC Converter With Sequency mode, LTC1261	Linear Tech	1
R1	10kΩ	0603, 1/16W	Rohm	1
R2	24Ω	0603, 1/16W	Rohm	1
R3	0.5Ω	1206, 1 W	Rohm	1
R4	1.5KΩ	0603, 1/16W	Rohm	1
R5	1KΩ	0603, 1/16W	Rohm	1
R6	430Ω	0603, 1/16W	Rohm	1
R7	10kΩ	0603, 1/16W	Rohm	1
C1,C2	0.1uF	0603	Murata	1
C3,C4,C5	4.7uF	1206	Taiyo Yuden	3
L1	1uH	0805	Taiyo Yuden	1

Package Dimensions (Type:SP-12)

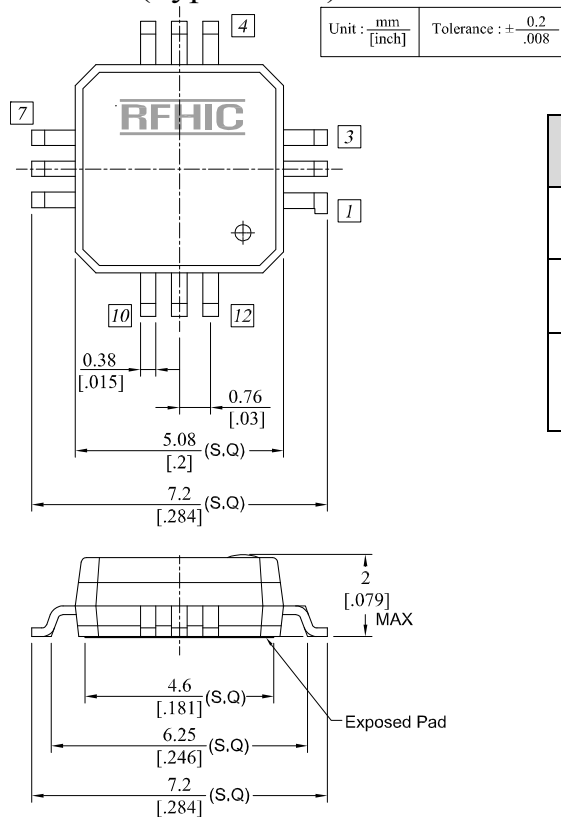

Function	Pin No.
Input	7, 8, 9
Output , Bias	1, 2, 3
Ground	4, 5, 6, 10, 11, 12 Backside Copper



RFHIC Corporation (RFHIC) reserves the right to make changes to any products herein or to discontinue any product at any time without notice. RFHIC do not assume any liability for the suitability of its products for any particular purpose, and disclaims any and all liability, including without limitation consequential or incidental damages. The product specifications herein expressed have been carefully checked and are assumed to be reliable. However, RFHIC disclaims liability for inaccuracies and strongly recommends buyers to verify that the information they are using is current before placing purchase orders. RFHIC products are not intended for use in life support equipment or application where malfunction of the product can be expected to result in personal injury or death. Buyer uses or sells such products for any such unintended or unauthorized application, buyer shall indemnify, protect and hold RFHIC and its directors, officers, stockholders, employees, representatives and distributors harmless against any and all claims arising out of such use. RFHIC's liability under or arising out of damages, claims of whatsoever kind and nature which RFHIC products could cause shall be limited in amount to the net purchase price of the products sold to buyer by RFHIC.