

MAAM71100

GaAs MMIC Power Amplifier 7.0 - 11.0 GHz

Rev. V5

Features

- +31 dBm Typical Saturated Power
- 18 dB Typical Gain
- 30% Typical Power Added Efficiency
- On-Chip Bias Network
- DC Decoupled RF Input and Output

Description

M/A-COM's MAAM71100 is a GaAs MMIC two stage high efficiency power amplifier. The MAAM71100 is a fully monolithic design for operation in 50-ohm systems, with an on-chip negative bias network which eliminates the need for external bias circuitry.

Die

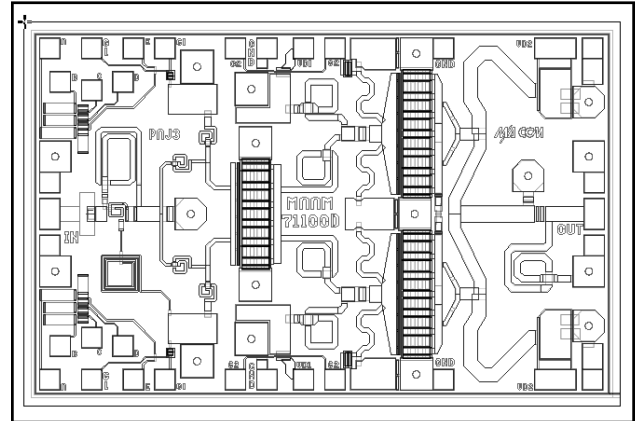

Ordering Information ¹

Part Number	Package
MAAM71100	Die

1. Die quantity varies.

Absolute Maximum Ratings ²

Parameter	Absolute Maximum
V_{DD}	+10 V
V_{GG}	-5 V
Input Power	+23 dBm
Operating Channel Temperature	+150°C
Storage Temperature	-65°C to +150°C

2. Exceeding any one or combination of these limits may cause permanent damage to this device.

Schematic

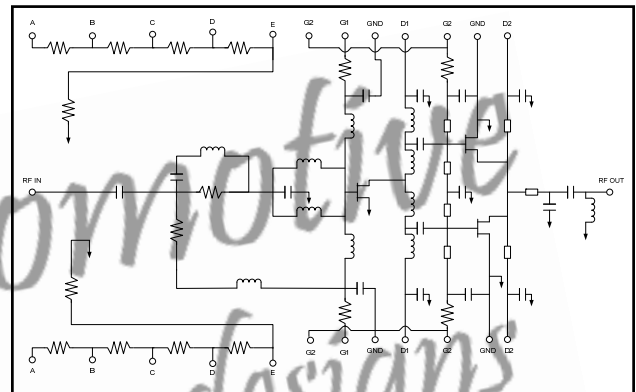

Electrical Specifications: $T_A = 25^\circ\text{C}$, $Z_0 = 50 \Omega$, $V_{DD} = +8 \text{ V}$, $V_{GG} = -1.2 \text{ V Typ}$

Parameter	Test Conditions	Units	Min.	Typ.	Max.
Gain	—	dB	14	18	—
Input VSWR	—	Ratio	—	2.0:1	—
Output VSWR	—	Ratio	—	4.5:1	—
Saturated Power Output	Input Power = +18 dBm	dBm	—	+31	—
Output Power at 1 dB Gain Compression	—	dBm	—	+28	—
Third Order Intercept	—	dBm	—	+38	—
Reverse Isolation	—	dB	—	30	—
Bias Current	I_{DSQ} (No RF) I_{DD} $P_{in} = +18 \text{ dBm}$	mA mA	— —	520 750	— —
Thermal Resistance	—	$^\circ\text{C/W}$	—	12	—

Typical Performance Curves

Linear Gain and Input Return Loss vs. Frequency

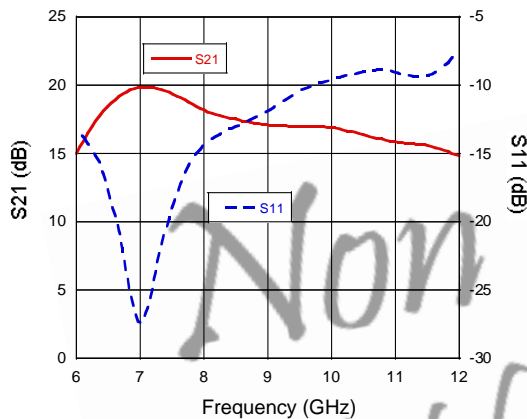

Output Power and Power added efficiency vs. Frequency @ $P_{in} = +18 \text{ dBm}$

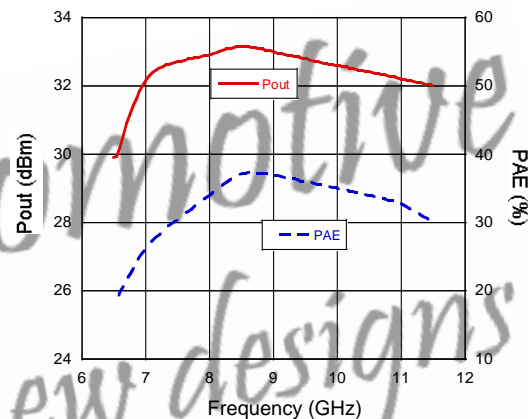

Output Power and Power added efficiency vs. Input Power @ 9 GHz

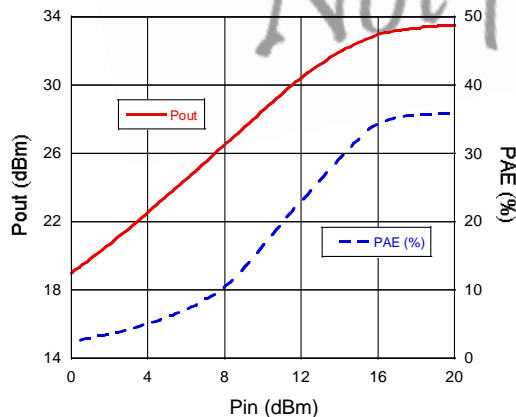

ADVANCED: Data Sheets contain information regarding a product M/A-COM Technology Solutions is considering for development. Performance is based on target specifications, simulated results, and/or prototype measurements. Commitment to develop is not guaranteed.
PRELIMINARY: Data Sheets contain information regarding a product M/A-COM Technology Solutions has under development. Performance is based on engineering tests. Specifications are typical. Mechanical outline has been fixed. Engineering samples and/or test data may be available. Commitment to produce in volume is not guaranteed.

- **North America** Tel: 800.366.2266 / Fax: 978.366.2266
- **Europe** Tel: 44.1908.574.200 / Fax: 44.1908.574.300
- **Asia/Pacific** Tel: 81.44.844.8296 / Fax: 81.44.844.8298

Visit www.macomtech.com for additional data sheets and product information.

M/A-COM Technology Solutions Inc. and its affiliates reserve the right to make changes to the product(s) or information contained herein without notice.

Handling Procedures

Permanent damage to the MAAM71100 may occur if the following precautions are not adhered to:

- Cleanliness - The MAAM71100 should be handled in a clean environment. DO NOT attempt to clean assembly after the MAAM71100 is installed.
- Static Sensitivity - All die handling equipment and personnel should comply with DOD-STD-1686 Class I.
- Transients - Avoid instrument and power supply transients while bias is connected to the MAAM71100. Use shielded signal and bias cables to minimize inductive pick-up.
- General Handling - DO NOT touch the surface of the die. It is recommended that the MAAM71100 die be handled along the long side with a sharp pair of tweezers.

Mounting

The MAAM71100 is back-metallized with Pd/Ni/Au (100/1, 000/30,000Å) metallization. It is recommended that the die be mounted with Au/Sn eutectic preforms. The attachment surface should be clean and flat.

- An 80/20 preform is recommended with a work surface temperature of approximately 255°C and a tool temperature of 265°C. When hot 90/5 nitrogen/hydrogen gas is applied, solder temperature should be approximately 290°C.
- DO NOT expose the MAAM71100 to a temperature greater than 320°C for more than 20 seconds. No more than 3 seconds of scrubbing should be required for attachment.

Bonding

- Ball or wedge bond with 1.0 mil diameter gold wire of 3.0 mil x 0.5 mil ribbon. Thermosonic bonding with a nominal stage temperature of 150°C and a ball bonding force of 40 to 50 grams or wedge bonding force of 18 to 22 grams is recommended. Ultrasonic energy and time should be adjusted to the minimum levels necessary to achieve reliable bonds.
- Bonds should be started on the die and terminated on the package.
- Bonding pads are 4.0 x 4.0 mils minimum.

Outline Drawing

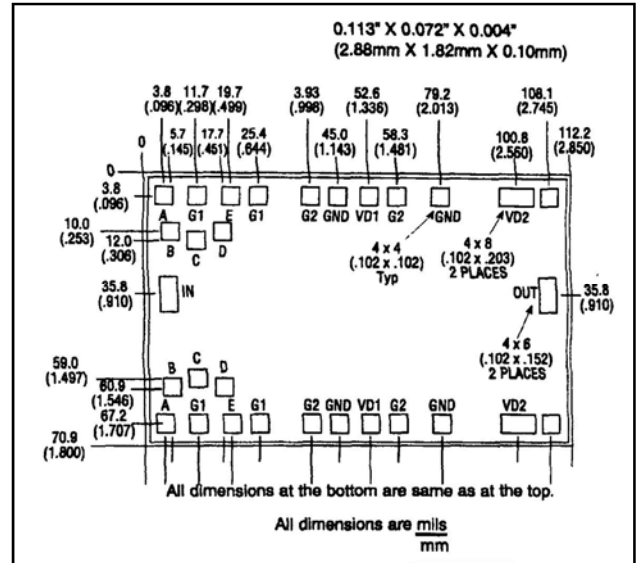

Typical Bias Configuration ^{3,4,5}

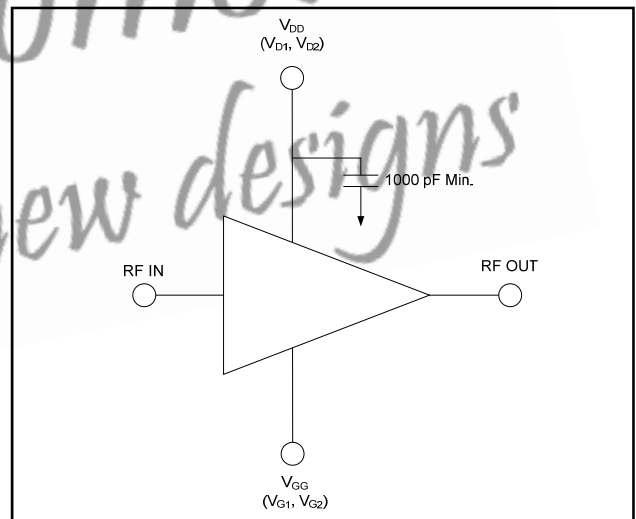

- Nominal bias is obtained by first connecting -1.2 volts to pads V_{G1} and V_{G2} followed by connecting +8 volts to pads V_{D1} and V_{D2} (note sequence).
- The recommended V_{DD} range is +6 to +9 volts.
- Optional on-chip resistor networks are used by connecting a nominal -5 volts to pad "A" and connecting pad "B", "C", "D", or "E" to pad V_{G1} ; and V_{G2} .