

General-purpose low voltage comparator

Features

- Supply operation from 2.7 to 5 V
- Low current consumption: 20 μ A
- Input common mode range includes ground
- Wide temperature range: -40°C to +85°C
- Low output saturation voltage
- Propagation delay: 200 ns
- Open drain output
- ESD tolerance: 2 kV HBM/200 V MM
- SMD packages: SC70-5 and SOT23-5

Applications

- Mobile phones
- Notebooks and PDAs
- Battery supplied electronics
- General-purpose portable devices
- General-purpose low voltage applications

Description

The LMV331 is a single and low voltage version of industry standard LM339 and LM393. It can operate with a supply voltage ranging from 2.7 to 5 V, and exhibits a lower current consumption than its predecessors LM339 and LM393. This device is a perfect choice for low-voltage applications.

The device is available in both SOT23-5 and SC70-5 packages, making it ideal for applications where space saving is a constraint. The SC70-5 package is approximately half the size of the SOT23-5.

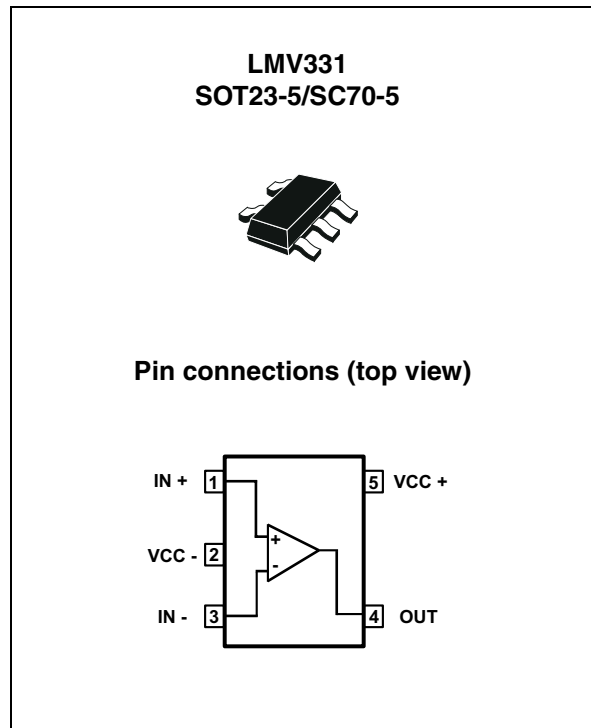

The LMV331 is designed to operate in the temperature range of -40°C to +85°C. It is then suitable for a large variety of applications.

1 Absolute maximum ratings and operating conditions

Table 1. Absolute maximum ratings

Symbol	Parameter	Value	Unit
V _{CC}	Supply voltage ⁽¹⁾	5.5	V
V _{ID}	Differential input voltage ⁽²⁾	± 5.5	V
V _{IN}	Input voltage range	(V _{CC-}) - 0.3 to (V _{CC+}) + 0.3	V
R _{thja}	Thermal resistance junction to ambient ⁽³⁾ SC70-5 SOT23-5	205 250	°C/W
R _{thjc}	Thermal resistance junction to case ⁽³⁾ SC70-5 SOT23-5	172 81	°C/W
T _{stg}	Storage temperature	-65 to +150	°C
T _j	Junction temperature	150	°C
T _{LEAD}	Lead temperature (soldering 10 seconds)	260	°C
ESD	Human body model (HBM) ⁽⁴⁾	2000	V
	Machine model (MM) ⁽⁵⁾	200	
	Charged device model (CDM) ⁽⁶⁾	1500	
	Latch-up immunity	200	mA

1. All voltage values, except differential voltage, are referenced to V_{cc-}.
2. The magnitude of input and output voltages must never exceed the supply rail ±0.3 V.
3. Short-circuits can cause excessive heating. These values are typical.
4. Human body model: a 100 pF capacitor is charged to the specified voltage, then discharged through a 1.5 kΩ resistor between two pins of the device. This is done for all couples of connected pin combinations while the other pins are floating.
5. Machine model: a 200 pF capacitor is charged to the specified voltage, then discharged directly between two pins of the device with no external series resistor (internal resistor < 5 Ω). This is done for all couples of connected pin combinations while the other pins are floating.
6. Charged device model: all pins and package are charged together to the specified voltage and then discharged directly to ground through only one pin. This is done for all pins.

Table 2. Operating conditions

Symbol	Parameter	Value	Unit
T _{oper}	Operating temperature range	-40 to +85	°C
V _{CC}	Supply voltage -40°C < T _{amb} < +85°C	2.7 to 5.0	V

2 Electrical characteristics

Table 3. $V_{CC}^+ = +2.7\text{ V}$, $V_{CC}^- = 0\text{ V}$, $T_{amb} = +25^\circ\text{ C}$, full V_{ICM} range (unless otherwise specified)⁽¹⁾

Symbol	Parameter	Test conditions	Min.	Typ.	Max.	Unit
V_{IO}	Input offset voltage			1	7	mV
ΔV_{IO}	Input offset voltage drift	$-40^\circ\text{C} < T_{amb} < +85^\circ\text{C}$		5		$\mu\text{V}/^\circ\text{C}$
I_{IB}	Input bias current ⁽²⁾	$-40^\circ\text{C} < T_{amb} < +85^\circ\text{C}$		25	250 400	nA
I_{IO}	Input offset current ⁽²⁾	$-40^\circ\text{C} < T_{amb} < +85^\circ\text{C}$		1	50 150	nA
V_{ICM}	Common mode input voltage			-0.1 2.0		V
V_{OL}	Output voltage low	$I_{SINK} = 1\text{ mA}$		20		mV
I_{SINK}	Output sink current	$V_{OUT} = 1.5\text{ V}$	5	47		mA
I_{CC}	Supply current	No load, output high, $V_{ICM} = 0\text{ V}$		20	100	μA
I_{OH}	Output current leakage	$-40^\circ\text{C} < T_{amb} < +85^\circ\text{C}$		0.003	1	μA
TP_{HL}	Propagation delay High to low output level	$V_{ICM} = 0\text{ V}$, $R_L = 5.1\text{ k}\Omega$, $C_L = 50\text{ pF}$ Overdrive = 10 mV Overdrive = 100 mV		300 200		ns
TP_{LH}	Propagation delay Low to high output level	$V_{ICM} = 0\text{ V}$, $R_L = 5.1\text{ k}\Omega$, $C_L = 50\text{ pF}$ Overdrive = 10 mV Overdrive = 100 mV		550 400		ns

1. All values over the temperature range are guaranteed through correlation and simulation. No production tests have been performed at the temperature range limits.
2. Maximum values include unavoidable inaccuracies of the industrial tests.

Table 4. $V_{CC}^+ = +5\text{ V}$, $V_{CC}^- = 0\text{ V}$, $T_{amb} = +25^\circ\text{C}$, full V_{ICM} range (unless otherwise specified)⁽¹⁾

Symbol	Parameter	Test conditions	Min.	Typ.	Max.	Unit
V_{IO}	Input offset voltage	$-40^\circ\text{C} < T_{amb} < +85^\circ\text{C}$		1	7 9	mV
ΔV_{IO}	Input offset voltage drift	$-40^\circ\text{C} < T_{amb} < +85^\circ\text{C}$		5		$\mu\text{V}/^\circ\text{C}$
I_{IB}	Input bias current ⁽²⁾	$-40^\circ\text{C} < T_{amb} < +85^\circ\text{C}$		25	250 400	nA
I_{IO}	Input offset current ⁽²⁾	$-40^\circ\text{C} < T_{amb} < +85^\circ\text{C}$		2	50 150	nA
V_{ICM}	Common mode input voltage			-0.1		V
				4.2		
A_V	Voltage gain		20	50		V/mV
V_{OL}	Output voltage low	$I_{SINK} < 4\text{ mA}$ $-40^\circ\text{C} < T_{amb} < +85^\circ\text{C}$		50	400 700	mV
I_{SINK}	Output sink current	$V_{OUT} < 1.5\text{ V}$	10	93		mA
I_{CC}	Supply current	No load, output high, $V_{ICM} = 0\text{ V}$ $-40^\circ\text{C} < T_{amb} < +85^\circ\text{C}$		25	120 150	μA
I_{OH}	Output current leakage	$-40^\circ\text{C} < T_{amb} < +85^\circ\text{C}$		0.003	1	μA
TP_{HL}	Propagation delay High to low output level	$V_{ICM} = 0\text{ V}$, $R_L = 5.1\text{ k}\Omega$, $C_L = 50\text{ pF}$ Overdrive = 10 mV Overdrive = 100 mV		375		ns
				275		
TP_{LH}	Propagation delay Low to high output level	$V_{ICM} = 0\text{ V}$, $R_L = 5.1\text{ k}\Omega$, $C_L = 50\text{ pF}$ Overdrive = 10 mV Overdrive = 100 mV		550		ns
				425		

1. All values over the temperature range are guaranteed through correlation and simulation. No production tests have been performed at the temperature range limits.
2. Maximum values include unavoidable inaccuracies of the industrial tests.

Figure 1. Supply current versus supply voltage with output high

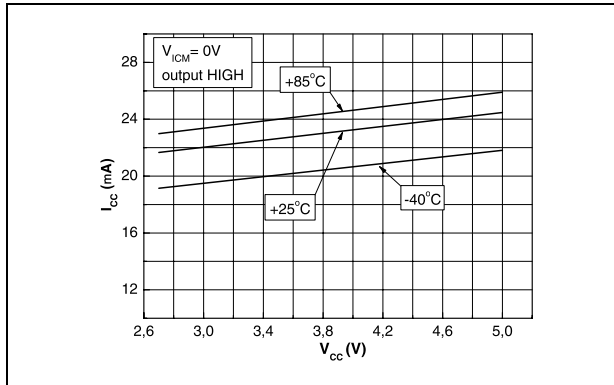

Figure 2. Supply current versus supply voltage with output low

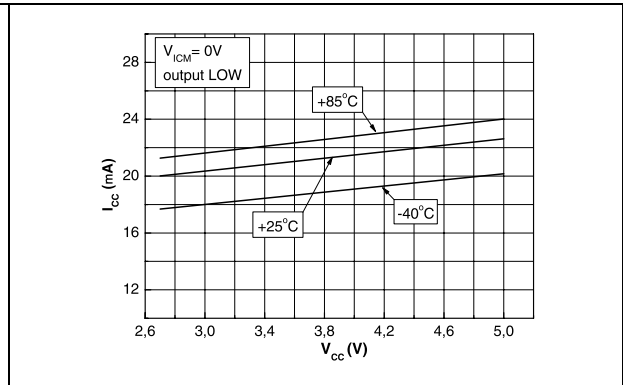

Figure 3. Output voltage versus output current at 5 V supply

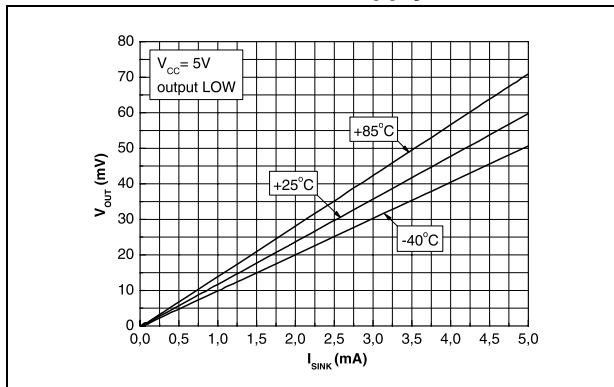

Figure 4. Output voltage versus output current at 2.7 V supply

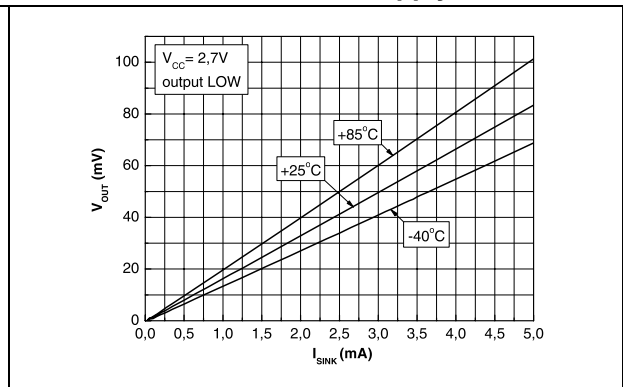

Figure 5. Input bias current versus supply voltage

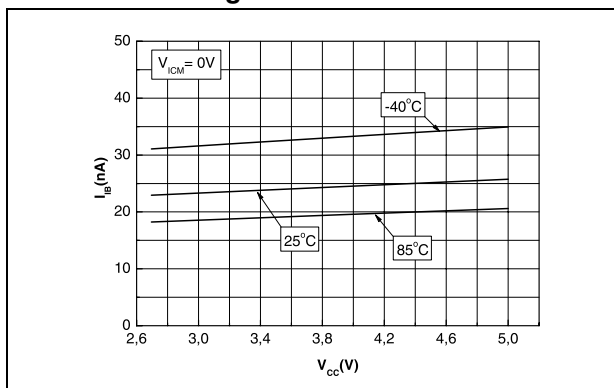

Figure 6. Response time versus overdrive with negative transition

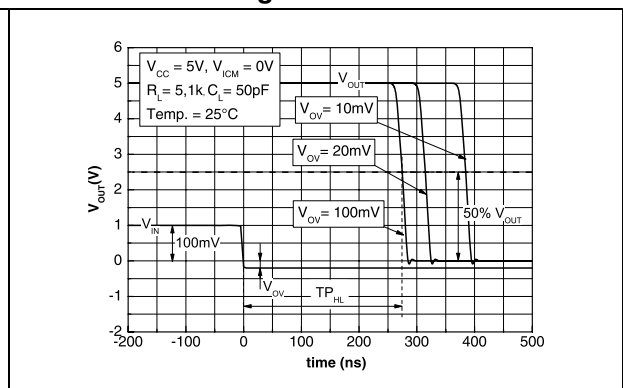

Figure 7. Response time versus overdrive with positive transition

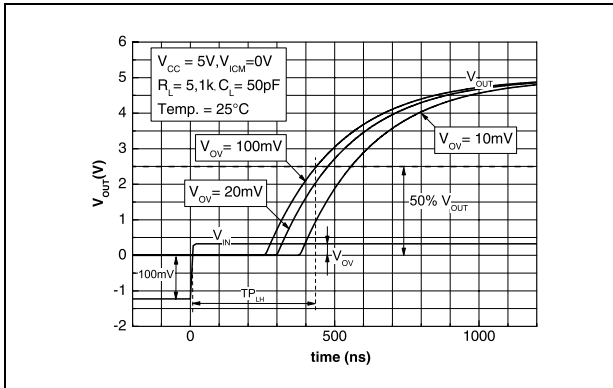

Figure 8. Response time versus overdrive with negative transition

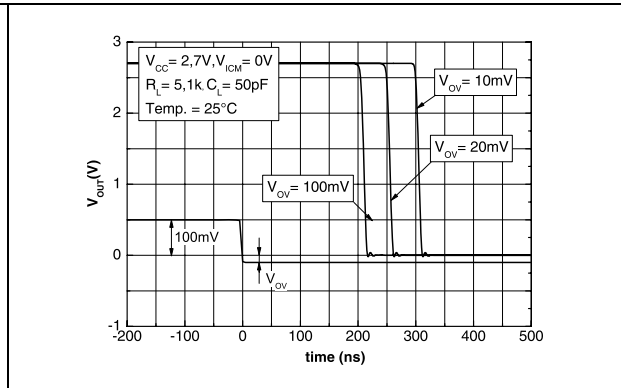
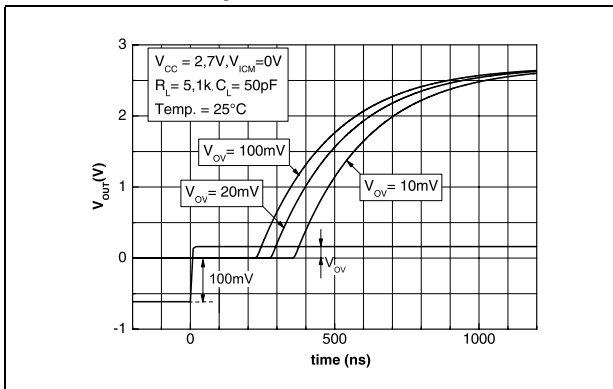

Figure 9. Response time versus overdrive with positive transition



3 Package information

In order to meet environmental requirements, ST offers these devices in different grades of ECOPACK[®] packages, depending on their level of environmental compliance. ECOPACK[®] specifications, grade definitions and product status are available at: www.st.com. ECOPACK[®] is an ST trademark.

3.1 SOT23-5 package

Figure 10. SOT23-5 package mechanical drawing

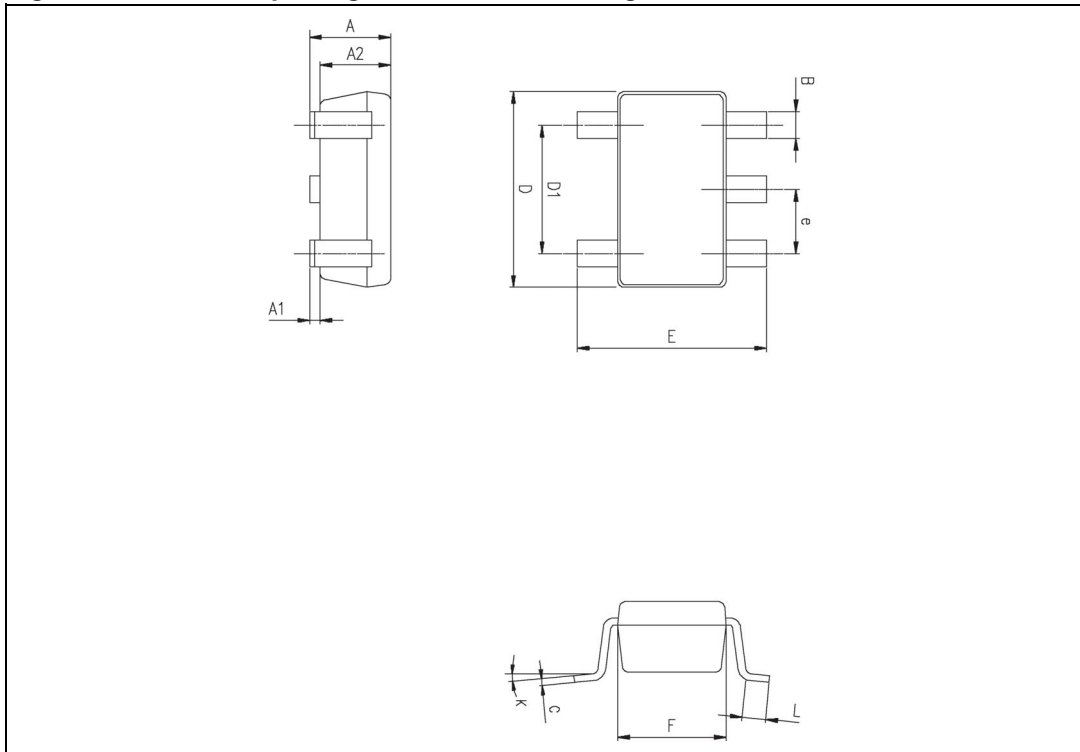

Table 5. SOT23-5 package mechanical data

Ref.	Dimensions					
	Millimeters			Inches		
	Min.	Typ.	Max.	Min.	Typ.	Max.
A	0.90	1.20	1.45	0.035	0.047	0.057
A1			0.15			0.006
A2	0.90	1.05	1.30	0.035	0.041	0.051
B	0.35	0.40	0.50	0.013	0.015	0.019
C	0.09	0.15	0.20	0.003	0.006	0.008
D	2.80	2.90	3.00	0.110	0.114	0.118
D1		1.90			0.075	
e		0.95			0.037	
E	2.60	2.80	3.00	0.102	0.110	0.118
F	1.50	1.60	1.75	0.059	0.063	0.069
L	0.10	0.35	0.60	0.004	0.013	0.023
K	0 degrees		10 degrees			

3.2 SC70-5 (SOT323-5) package

Figure 11. SC70-5 (SOT323-5) package mechanical drawing

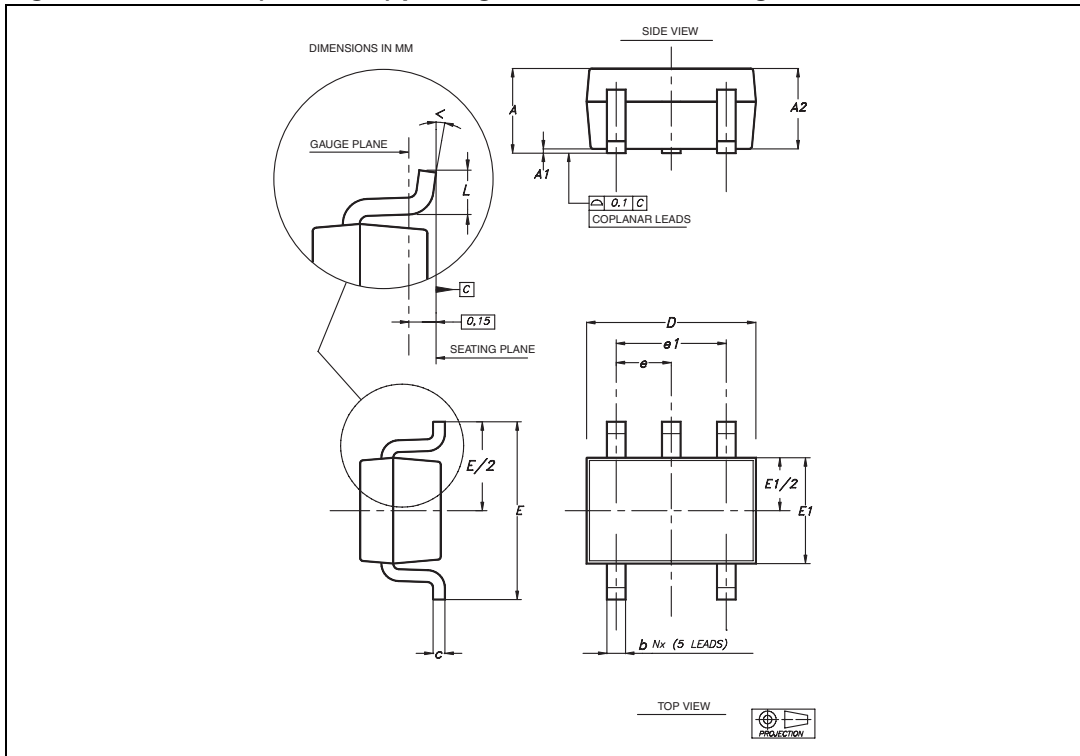

Table 6. SC70-5 (or SOT323-5) package mechanical data

Ref	Dimensions					
	Millimeters			Inches		
	Min	Typ	Max	Min	Typ	Max
A	0.80		1.10	0.315		0.043
A1			0.10			0.004
A2	0.80	0.90	1.00	0.315	0.035	0.039
b	0.15		0.30	0.006		0.012
c	0.10		0.22	0.004		0.009
D	1.80	2.00	2.20	0.071	0.079	0.087
E	1.80	2.10	2.40	0.071	0.083	0.094
E1	1.15	1.25	1.35	0.045	0.049	0.053
e		0.65			0.025	
e1		1.30			0.051	
L	0.26	0.36	0.46	0.010	0.014	0.018
α	0°		8°			

4 Ordering information

Table 7. Order codes

Part number	Temperature range	Package	Packaging	Marking
LMV331ILT	-40°C, +85°C	SOT23-5	Tape & reel	K503
LMV331ICT		SC70-5	Tape & reel	K50

5 Revision history

Table 8. Document revision history

Date	Revision	Changes
10-Dec-2009	1	Initial release.

Please Read Carefully:

Information in this document is provided solely in connection with ST products. STMicroelectronics NV and its subsidiaries ("ST") reserve the right to make changes, corrections, modifications or improvements, to this document, and the products and services described herein at any time, without notice.

All ST products are sold pursuant to ST's terms and conditions of sale.

Purchasers are solely responsible for the choice, selection and use of the ST products and services described herein, and ST assumes no liability whatsoever relating to the choice, selection or use of the ST products and services described herein.

No license, express or implied, by estoppel or otherwise, to any intellectual property rights is granted under this document. If any part of this document refers to any third party products or services it shall not be deemed a license grant by ST for the use of such third party products or services, or any intellectual property contained therein or considered as a warranty covering the use in any manner whatsoever of such third party products or services or any intellectual property contained therein.

UNLESS OTHERWISE SET FORTH IN ST'S TERMS AND CONDITIONS OF SALE ST DISCLAIMS ANY EXPRESS OR IMPLIED WARRANTY WITH RESPECT TO THE USE AND/OR SALE OF ST PRODUCTS INCLUDING WITHOUT LIMITATION IMPLIED WARRANTIES OF MERCHANTABILITY, FITNESS FOR A PARTICULAR PURPOSE (AND THEIR EQUIVALENTS UNDER THE LAWS OF ANY JURISDICTION), OR INFRINGEMENT OF ANY PATENT, COPYRIGHT OR OTHER INTELLECTUAL PROPERTY RIGHT.

UNLESS EXPRESSLY APPROVED IN WRITING BY AN AUTHORIZED ST REPRESENTATIVE, ST PRODUCTS ARE NOT RECOMMENDED, AUTHORIZED OR WARRANTED FOR USE IN MILITARY, AIR CRAFT, SPACE, LIFE SAVING, OR LIFE SUSTAINING APPLICATIONS, NOR IN PRODUCTS OR SYSTEMS WHERE FAILURE OR MALFUNCTION MAY RESULT IN PERSONAL INJURY, DEATH, OR SEVERE PROPERTY OR ENVIRONMENTAL DAMAGE. ST PRODUCTS WHICH ARE NOT SPECIFIED AS "AUTOMOTIVE GRADE" MAY ONLY BE USED IN AUTOMOTIVE APPLICATIONS AT USER'S OWN RISK.

Resale of ST products with provisions different from the statements and/or technical features set forth in this document shall immediately void any warranty granted by ST for the ST product or service described herein and shall not create or extend in any manner whatsoever, any liability of ST.

ST and the ST logo are trademarks or registered trademarks of ST in various countries.

Information in this document supersedes and replaces all information previously supplied.

The ST logo is a registered trademark of STMicroelectronics. All other names are the property of their respective owners.

© 2009 STMicroelectronics - All rights reserved

STMicroelectronics group of companies

Australia - Belgium - Brazil - Canada - China - Czech Republic - Finland - France - Germany - Hong Kong - India - Israel - Italy - Japan - Malaysia - Malta - Morocco - Philippines - Singapore - Spain - Sweden - Switzerland - United Kingdom - United States of America

www.st.com