

**C-15-1250AC-TDFB3-SSC2(4)C-14-G5**



**Features**

- SC Duplex Single Mode Transceiver
- Industry Standard 1x9 Footprint
- Gigabit Ethernet Compliant
- Single +3.3 Power Supply
- LVPECL Differential Inputs and Outputs (AC-coupling)
- LVTTTL Signal Detection Output
- Wave Solderable and Aqueous Washable
- Uncooled laser diode with MQW structure
- Complies with Telcordia (Bellcore) GR-468-CORE
- Gigabit Ethernet Application
- RoHS compliance available

**Absolute Maximum Rating**

Parameter	Symbol	Min.	Max.	Unit	Note
Power Supply Voltage	V <sub>CC</sub>	0	3.6	V	
Output Current	I <sub>out</sub>	0	30	mA	
Soldering Temperature	-	-	260	°C	10 seconds on leads only
Storage Temperature	T <sub>stg</sub>	-40	85	°C	

**Recommended Operating Condition**

Parameter	Symbol	Min.	Typ.	Max.	Unit
Power Supply Voltage	V <sub>CC</sub>	3.1	3.3	3.5	V
Operating Temperature (Case)	T <sub>opr</sub>	-40	-	85	°C
Data Rate	-	-	1250	-	Mbps

**Transmitter Specifications (Optical)**

Parameter	Symbol	Min	Typical	Max	Unit	Notes
Optical Transmit Power	P <sub>o</sub>	-5	-	0	dBm	C-15-1250AC-TDFB3-SSC2C-14-G5
Optical Transmit Power	P <sub>o</sub>	0	-	+5	dBm	C-15-1250AC-TDFB3-SSC4C-14-G5
Output center Wavelength	λ	1500	1550	1600	nm	
Output Spectrum Width	Δλ	-	-	1	nm	-20 dB width
Side Mode Suppression Ratio	SMSR	30	35	-	dB	
Extinction Ratio	ER	9	-	-	dB	
Output Eye		Compliant with IEEE 802.3				
Optical Rise Time	t <sub>r</sub>	-	-	0.26	ns	20% to 80% Values
Optical Fall Time	t <sub>f</sub>	-	-	0.26	ns	20% to 80% Values
Relative Intensity Noise	RIN	-	-	-120	dB/Hz	
Total Jitter	TJ	-	-	0.27	ns	Measured with 2 <sup>7</sup> -1 PRBS

## C-15-1250AC-TDFB3-SSC2(4)C-14-G5

### Transmitter Specifications (Electrical)

Parameter	Symbol	Min	Typical	Max	Unit	Notes
Power Supply Current	$I_{CC}$	-	-	180	mA	Maximum current is specified at $V_{CC}$ = Maximum @ maximum temperature
Data Input Current-Low	$I_{IL}$	-350	-	-	$\mu$ A	
Data Input Current-High	$I_{IH}$	-	-	350	$\mu$ A	
Differential Input Voltage	$V_{IH}-V_{IL}$	300	-	-	mV	
Data Input Voltage-Low	$V_{IL}-V_{CC}$	-2.0	-	-1.58	V	These inputs are compatible with 10K, 10KH and 100K ECL and PECL inputs
Data Input Voltage-High	$V_{IH}-V_{CC}$	-1.1	-	-0.74	V	

### Receiver Specifications (Optical)

Parameter	Symbol	Min	Typical	Max	Unit	Notes
Sensitivity <sup>1</sup>	-	-	-	-24	dBm	
Maximum Input Power	$P_{in}$	0	-	-	dBm	
Signal Detect-Asserted	$P_a$	-	-	-24	dBm	Measured on transition: low to high
Signal Detect-Deasserted	$P_d$	-38	-	-	dBm	Measured on transition: high to low
Signal Detect-Hysteresis		1	-	-	dB	
Wavelength of Operation		1100	-	1600	nm	

Note 1: Measured with 2<sup>7</sup>-1 PRBS, BER= 10<sup>-12</sup>

### Receiver Specifications (Electrical)

Parameter	Symbol	Min	Typical	Max	Unit	Note
Power Supply Current	$I_{CC}$	-	-	100	mA	The current excludes the output load current
Data output Voltage-Low	$V_{OL}-V_{CC}$	-2.0	-	-1.58	V	These outputs are compatible with 10K, 10KH and 100KECL and LVPECL outputs
Data output Voltage-High	$V_{OH}-V_{CC}$	-1.1	-	-0.74	V	
Differential Data Output Voltage	$V_{OH}-V_{OL}$	600	-	1600	V	AC-coupled
Signal Detect Output Voltage-Low	$V_{SDL}$	-	-	0.5	V	LVTTTL
Signal Detect Output Voltage-High	$V_{SDH}$	2	-	$V_{CC}$	V	

**Connection Diagram**

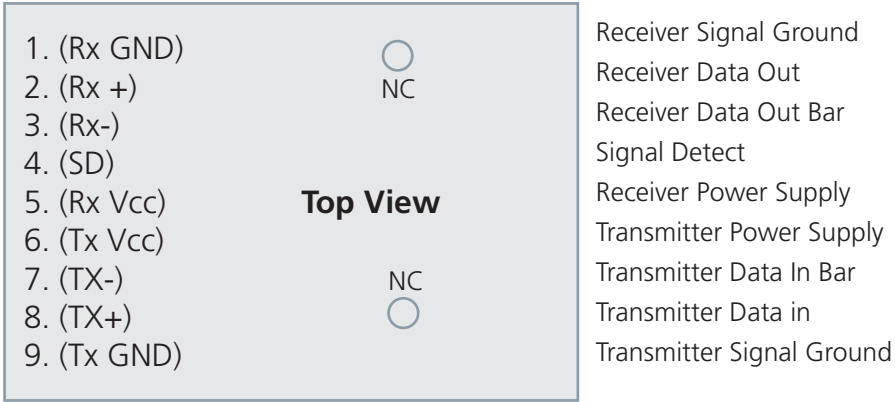

PIN	Symbol	Notes
1	RxGND	Directly connect this pin to the receiver ground plane
2	RD+	See recommended circuit schematic
3	RD-	See recommended circuit schematic
4	SD	Active high on this indicates a received optical signal
5	RxVcc	DC power for the receiver section
6	TxVcc	DC power for the transmitter section
7	TD-	See recommended circuit schematic
8	TD+	See recommended circuit schematic
9	TxGND	Directly connect this pin to the transmitter ground plane

**C-15-1250AC-TDFB3-SSC2(4)C-14-G5**

**Recommended Circuit Schematic**

C-15-1250AC-TDFB3-SSC2(4)C-14-G5

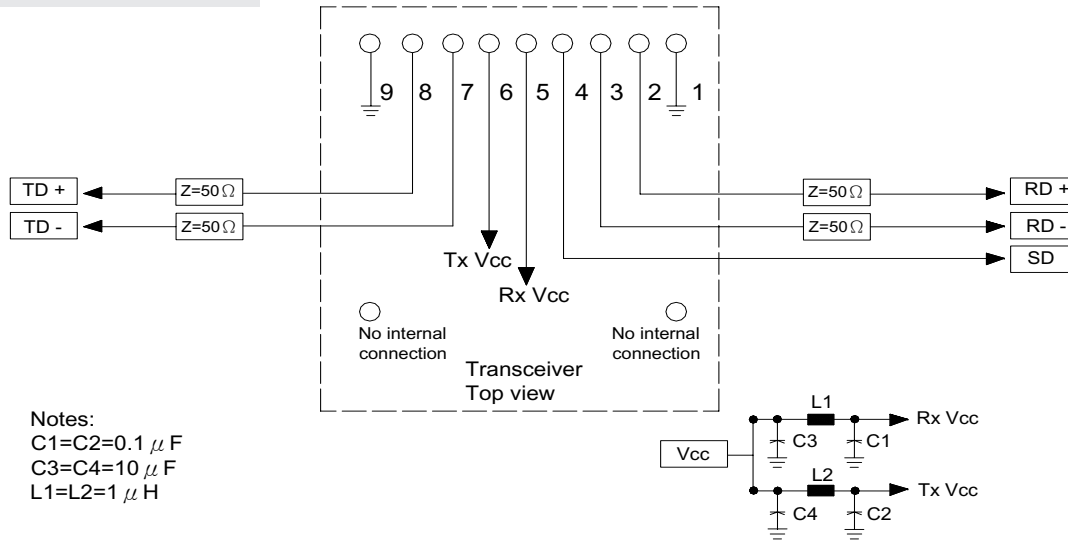

The split-loaded terminations for ECL signals need to be located at the input of devices receiving those ECL signals. The power supply filtering is required for good EMI performance. Use short tracks from the inductor L1/L2 to the module Rx Vcc. A GND plane under the module is required for good EMI and sensitivity performance.

**Label**

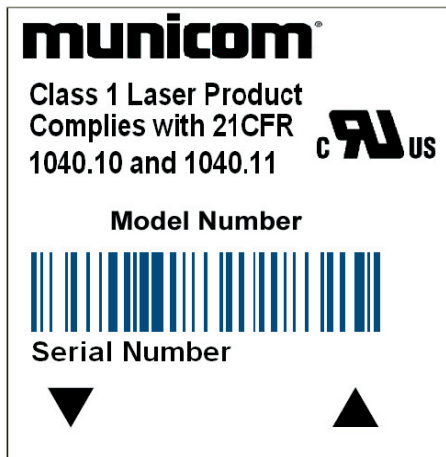

**Model Number:**  
 C-15-1250AC-TDFB3-SSC2C-14-G5  
 C-15-1250AC-TDFB3-SSC4C-14-G5

Package Diagram

**Top View**

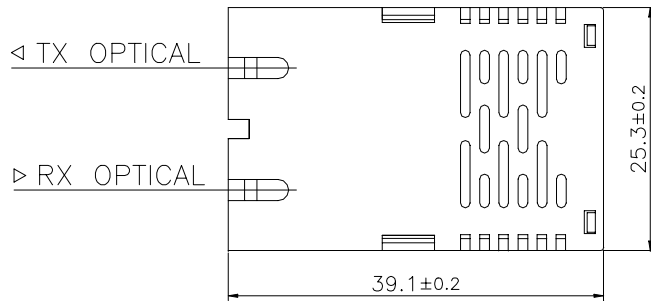

**Front View**

Units: mm

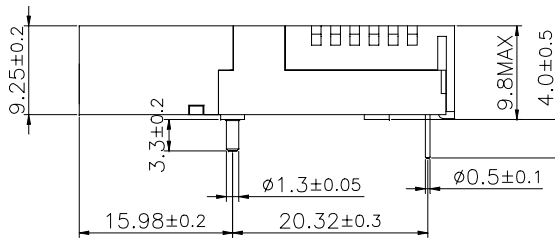
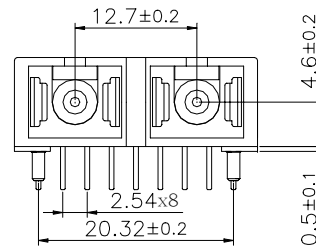

**Side View**

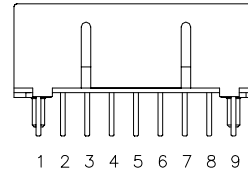

**Rear View**

Package Option :  
C = Black case

**C-15-1250AC-TDFB3-SSC2(4)C-14-G5**

**Ordering Information**

Available Options:  
 C-15-1250AC-TDFB3-SSC2C-14-G5  
 C-15-1250AC-TDFB3-SSC4C-14-G5

Part numbering Definition:

**C - 15 - 1250AC - TDFB3 - S SC TxPower Temperature and Package -14 -RoHS**

- 15 = Wavelength 1550nm
- Communication protocol (1250 Mbps)  
 AC = AC coupling for data input/output  
 TTL Signal Detection output
- TDFB3= +3.3V Transceiver, DFB
- Single mode fiber
- Connector options
- Tx Power range  
 2 = -5 to 0 dBm  
 4 = 0 to +5 dBm
- Temperature range and package  
 C = industrial temperature(-40 to 85 °C), 9.8 mm, Black case
- -14 : Municom customization label
- Ordering Information  
 G5 = RoHS 5/6-compliant product (lead exemption)

### Warnings:

**Handling Precautions:** This device is susceptible to damage as a result of electrostatic discharge (ESD). A static free environment is highly recommended. Follow guidelines according to proper ESD procedures.

**Laser Safety:** Radiation emitted by laser devices can be dangerous to human eyes. Avoid eye exposure to direct or indirect radiation.

### Legal Notes:

**IMPORTANT NOTICE!**

All information contained in this document is subject to change without notice, at Municom's sole and absolute discretion. Municom warrants performance of its products to current specifications only in accordance with the company's standard one-year warranty; however, specifications designated as "preliminary" are given to describe components only, and Municom expressly disclaims any and all warranties for said products, including express, implied, and statutory warranties, warranties of merchantability, fitness for a particular purpose, and non-infringement of proprietary rights. Please refer to the company's Terms and Conditions of Sale for further warranty information.

Municom assumes no liability for applications assistance, customer product design, software performance, or infringement of patents, services, or intellectual property described herein. No license, either express or implied, is granted under any patent right, copyright, or intellectual property right, and Municom makes no representations or warranties that the product(s) described herein are free from patent, copyright, or intellectual property rights. Products described in this document are NOT intended for use in implantation or other life support applications where malfunction may result in injury or death to persons. Municom customers using or selling products for use in such applications do so at their own risk and agree to fully defend and indemnify Municom for any damages resulting from such use or sale.

THE INFORMATION CONTAINED IN THIS DOCUMENT IS PROVIDED ON AN "AS IS" BASIS. Customer agrees that Municom is not liable for any actual, consequential, exemplary, or other damages arising directly or indirectly from any use of the information contained in this document. Customer must contact Municom to obtain the latest version of this publication to verify, before placing any order, that the information contained herein is current.

All rights reserved