

### ■ FEATURES

- Low dropout voltage: 180mV at 300mA ( $V_o=3.3V$ )
- Quiescent current: Typ. 65 $\mu A$
- 2% Voltage Accuracy
- High PSRR: 70dB at 1KHz
- Thermal Shutdown
- Current Limiting
- Excellent line and load regulation
- Fast response
- Short circuit protection
- Low temperature coefficient
- Space saving SOT23-3L package

### ■ GENERAL DESCRIPTION

The FSP2131 series of positive voltage linear regulators feature low quiescent current (Typ. 65 $\mu A$ ) and low dropout voltage, making them ideal for battery powered applications. Their high PSRR make them useful in applications where AC noise on the input power supply must be suppressed. Space saving SOT23-3L package is attractive for portable and handheld applications. They have both thermal shutdown and a current limit feature to prevent device failure from extreme operating conditions. They are stable with an output capacitor of 2.2 $\mu F$  or greater.

### ■ APPLICATIONS

- Cordless phones
- Cellular phones
- Bluetooth earphones
- Digital Cameras
- Portable electronics
- WLANs
- MP3 players

### ■ PIN CONFIGURATION

(Top View)

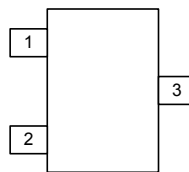

### ■ PIN DESCRIPTION

Pin Number	Pin Name	Pin Function
1	VIN	Input
2	VOU	Output
3	GND	Ground

### ■ BLOCK DIAGRAM

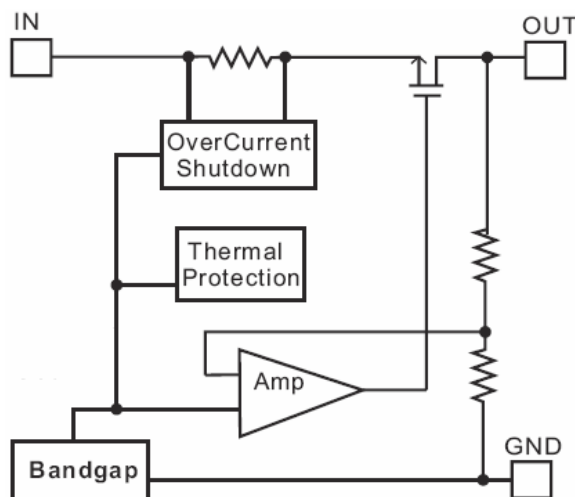

### ■ TYPICAL APPLICATIONS CIRCUITS

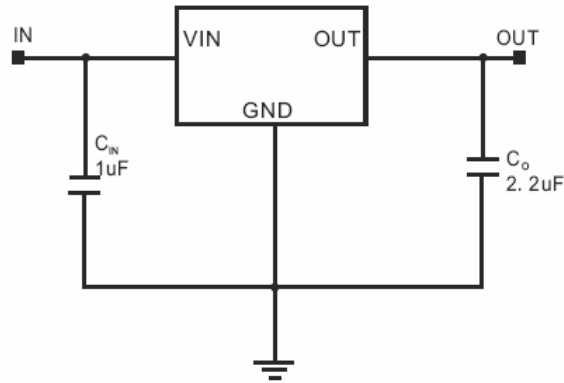

### ■ ABSOLUTE MAXIMUM RATINGS

Parameter	Rating	Unit
Input Supply Voltage	+6	V
Output Current	300	mA
Output Pin Voltage	GND-0.3 to VIN+0.3	V
ESD Rating	Class B	
Internal Power Dissipation	400	mW
Junction to Case Thermal Resistance ( $\theta_{JC}$ )	130	$^{\circ}\text{C}/\text{W}$
Junction to Ambient Thermal Resistance ( $\theta_{JA}$ )	250	$^{\circ}\text{C}/\text{W}$
Operating temperature	-40 to 85	$^{\circ}\text{C}$
Operating Junction Temperature	-40 to 125	$^{\circ}\text{C}$
Storage Temperature	-65 to 150	$^{\circ}\text{C}$
Lead Temperature (Soldering, 5 sec)	300	$^{\circ}\text{C}$

Note: Absolute Maximum Ratings are those values beyond which the life of a device may be impaired.

**■ ELECTRICAL CHARACTERISTICS**

 ( $V_{IN} = V_O + 1V$ ,  $C_{IN} = 1\mu F$ ,  $C_O = 2.2\mu F$ ,  $T_A = 25^\circ C$  unless otherwise specified.)

PARAMETER	SYMBOL	TEST CONDITIONS		MIN	TYP	MAX	UNIT
Input Voltage	$V_{IN}$			Note1		5.5	V
Output Voltage Accuracy	$V_O$	$I_O = 1mA$		-2		+2	%
Output Current	$I_O$			300		Note2	mA
Ground Current	$I_{GND}$	$I_O = 1mA$ to 300mA			70	90	$\mu A$
Quiescent Current	$I_Q$	$I_O = 0mA$			65	90	$\mu A$
Line Regulation	LNR	$I_O = 1mA$ , $V_O < 2V$ $V_{IN} = 2.8V$ to $3.8V$		-0.15	0.1	0.15	%V
		$I_O = 1mA$ , $2 \leq V_O < 3.3V$ $V_{IN} = V_O + 0.5V$ to $V_O + 1V$		-0.1	0.03	0.1	
		$I_O = 1mA$ , $V_O \geq 3.3V$ $V_{IN} = V_O + 0.5V$ to $V_O + 1V$		-0.4	0.2	0.4	
Load Regulation Error	LDR	$I_O = 1mA$ to 300mA		-1	0.2	1	%
Temperature Coefficient	$T_C$	$I_O = 1mA$			40		ppm/ $^\circ C$
Over Temperature Shutdown	OTS	$I_O = 1mA$			150		$^\circ C$
Over Temperature Hystersis	OTH	$I_O = 1mA$			30		$^\circ C$
Power Supply Ripple Rejection (with bypass Cap.)	PSRR	$I_O = 100mA$ $C_{BYP} = 10nF$ $V_O = 1.8V$	$f = 100Hz$		70		dB
			$f = 1KHz$		70		
			$f = 10KHz$		50		
Power Supply Ripple Rejection (without bypass Cap.)	PSRR	$I_O = 100mA$ $V_O = 1.8V$	$f = 100Hz$		70		dB
			$f = 1KHz$		60		
			$f = 10KHz$		40		
Dropout Voltage	$V_{DO}$	$I_O = 300mA$	$V_O = 1.8V$		850	1100	mV
			$2.5 \leq V_O < 3.3V$		370	450	
			$V_O \geq 3.3V$		180	230	
Output Noise	$V_n$	$C_{BYP} = 10nF$ , $f = 10Hz$ to $100kHz$			50		$\mu V_{RMS}$

Note 1: The minimum input voltage of the FSP2131 is determined by output voltage and dropout voltage. The minimum input voltage is defined as:

$$V_{IN(MIN)} = V_O + V_{DROP}$$

 Note 2: Output current is limited by  $P_D$ , maximum  $I_O = P_D / (V_{IN(MAX)} - V_O)$

## ■ APPLICATION INFORMATION

### Capacitor Selection and Regulator Stability

Similar to any low dropout regulator, the external capacitors used with the FSP2131 must be carefully selected for regulator stability and performance.

Using a capacitor,  $C_{IN}$ , whose value is  $> 1 \mu F$  at the FSP2131 input pin, the amount of the capacitance can be increased without limit. Please note that the distance between  $C_{IN}$  and the input pin of the FSP2131 should not exceed 0.5 inch. Ceramic capacitors are suitable for the FSP2131. Capacitors with larger values and lower ESR provide better PSRR and line-transient response.

The FSP2131 is designed specifically to work with low ESR ceramic output capacitors in order to save space and improve performance. Using an output ceramic capacitor whose value is  $> 2.2 \mu F$  with  $ESR > 5m\Omega$  ensure stability. A 10nF bypass capacitor connected to BYP pin is suggested for suppressing output noise. The capacitor, in series connection with an internal 200k $\Omega$  resistor, forms a low-pass filter for noise reduction. Increasing the capacitance will slightly decrease the output noise, but increase the start-up time.

### Load Transient Considerations

The figure11 shows the FSP2131 load transient response. It shows two components the output response: a DC shift from the output impedance due to the load current change and transient response. The DC shift is quite small due to excellent load regulation of the FSP2131. The transient spike, resulting from a step change in the load current from 1mA to 300mA, is 20mV. The ESR of the output capacitor is critical to the transient spike. A larger capacitance along with smaller ESR results in a smaller spike.

### Internal P-Channel Pass Transistor

The FSP2131 features a 0.75 $\Omega$  P-Channel MOSFET device as a pass transistor. The P-MOS pass transistor enables the FSP2131 to consume only 65  $\mu A$  of ground current during low dropout, light load, or heavy load operations. This feature increases the battery operation life time.

### Dropout Voltage

A regulator's minimum dropout voltage determines the lowest usable supply voltage. The FSP2131 has a typical 300mV dropout voltage. In battery powered systems, this will determine the useful end-of-life battery voltage.

### Current Limit and Short Circuit Protection

The FSP2131 features a current limit, which monitors and controls the gate voltage of the pass transistor. The output current can be limited to 400mA by regulating the gate voltage. The FSP2131 also has a built-in short circuit current limit.

### Thermal Considerations

Thermal protection limits power dissipation in the FSP2131. When the junction temperature exceeds 150 $^{\circ}C$ , the OTP (Over Temperature Protection) starts the thermal shutdown and turns the pass transistor off. The pass transistor resumes operation after the junction temperature drops below 120 $^{\circ}C$ .

For continuous operation, the junction temperature should be maintained below 125 $^{\circ}C$ . The power dissipation is defined as :

$$P_D = (V_{IN} - V_{OUT}) * I_O + V_{IN} * I_{GND}$$

The maximum power dissipation depends on the thermal resistance of IC package, PCB layout, the rate of surrounding airflow and temperature difference between junction and ambient. The maximum power dissipation can be calculated by the following formula:

$$P_{D(MAX)} = (T_{J(MAX)} - T_A) / \theta_{JA}$$

Where  $T_{J(MAX)}$  is the maximum allowable junction temperature 125 $^{\circ}C$ .  $T_A$  is the ambient temperature and  $\theta_{JA}$  is the thermal resistance from the junction to the ambient.

For example,  $\theta_{JA}$  is 250 $^{\circ}C/W$  for the SOT23-3L package, based on the standard JEDEC 51-3 for a single layer thermal test board. The maximum power dissipation at  $T_A=25^{\circ}C$  can be calculated by the following formula:

$$P_{D(MAX)} = (125^{\circ}C - 25^{\circ}C) / 250 = 0.4W$$

It is also useful to calculate the junction temperature of the FSP2131 under a set of specific conditions. In this example let the input voltage  $V_{IN}=3.3V$ , the output current  $I_O=300mA$  and the case temperature  $T_A=40^{\circ}C$  measured by a thermal couple during operation. The power dissipation for the  $V_O=2.8V$  version of the FSP2131 can be calculated as:

$$P_D = (3.3V - 2.8V) * 300mA + 3.3V * 70 \mu A \approx 150mW$$

And the junction temperature,  $T_J$ , can be calculated as follows:

$$T_J = T_A + P_D * \theta_{JA}$$

$$T_J = 40^{\circ}C + 0.15W * 250^{\circ}C/W$$

$$= 77.5^{\circ}C < T_{J(MAX)} = 125^{\circ}C$$

For this operating condition,  $T_J$  is lower than the absolute maximum operating junction temperature, 125 $^{\circ}C$ , so it is safe to use the FSP2131 in this configuration.

### TYPICAL PERFORMANCE CHARACTERISTICS

( $V_{IN} = V_{EN}$ ,  $C_{IN} = 1\mu F$ ,  $C_O = 2.2\mu F$ ,  $C_{BYP} = 10nF$ ,  $T_A = 25^\circ C$  unless otherwise specified.)

1. Output Voltage vs Input Voltage

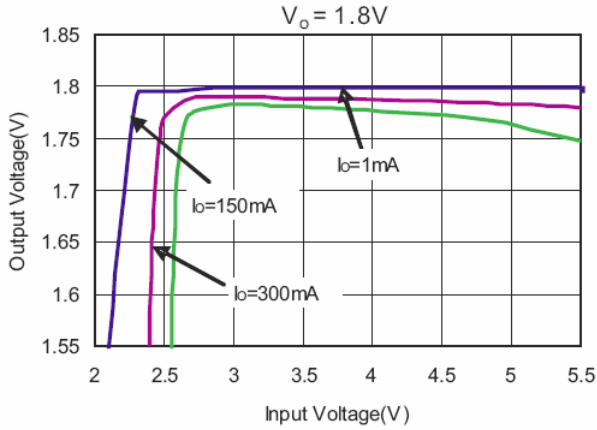

2. Output Voltage vs Output Current

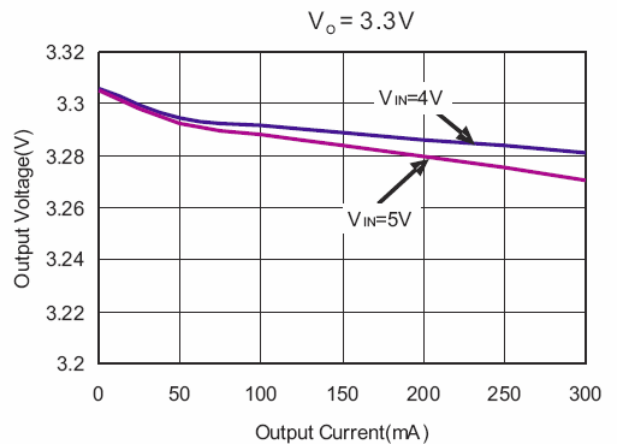
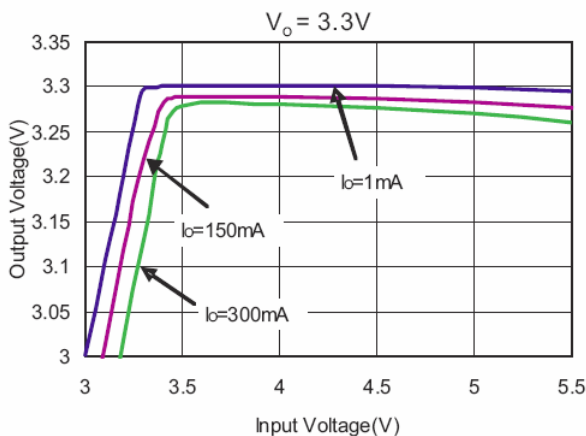
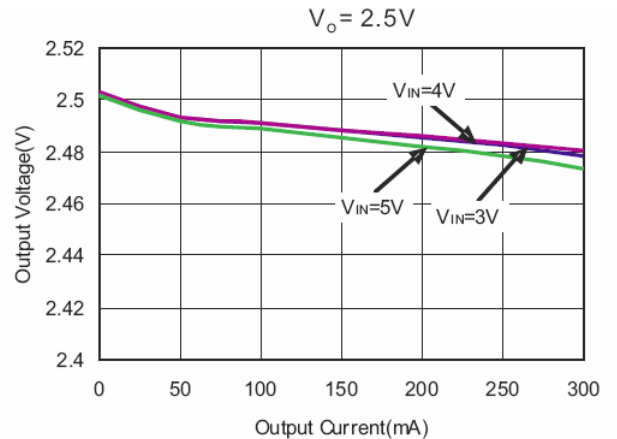
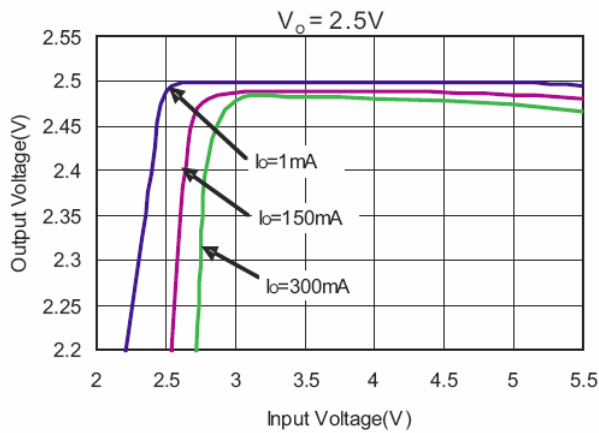
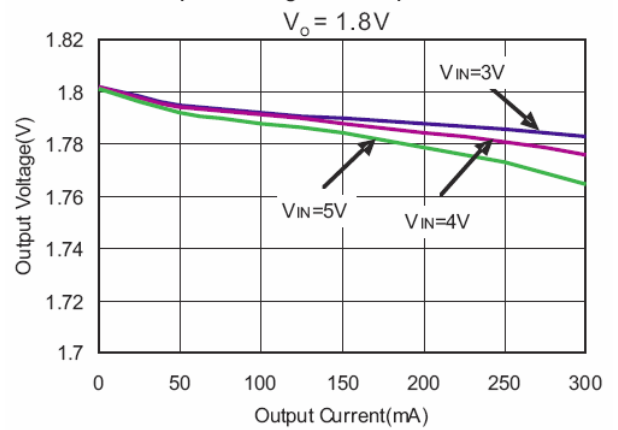

### ■ TYPICAL PERFORMANCE CHARACTERISTICS (CONTINUED)

( $V_{IN} = V_{EN}$ ,  $C_{IN} = 1\mu F$ ,  $C_O = 2.2\mu F$ ,  $C_{BYP} = 10nF$ ,  $T_A = 25^\circ C$  unless otherwise specified.)

3. Output Voltage vs Temperature

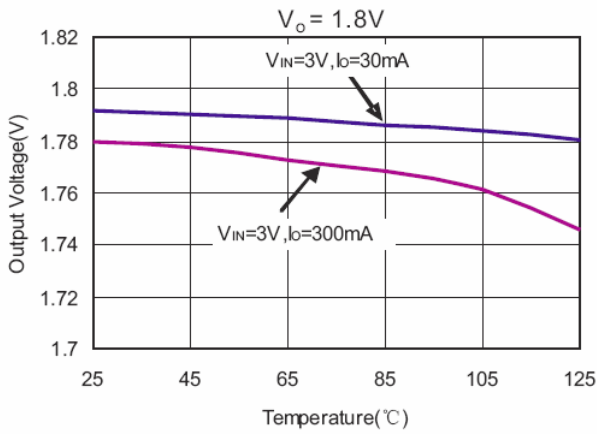

4. Ground Current vs Input Voltage

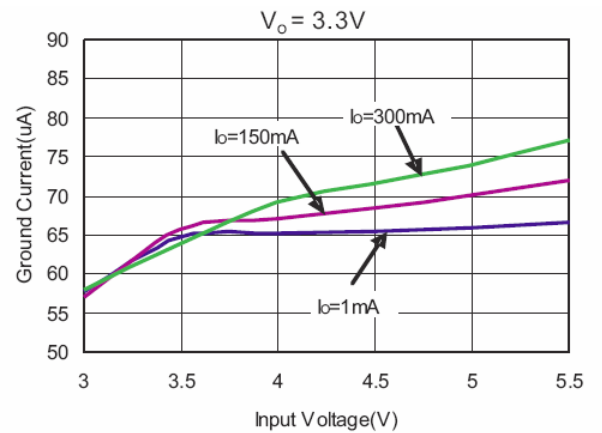
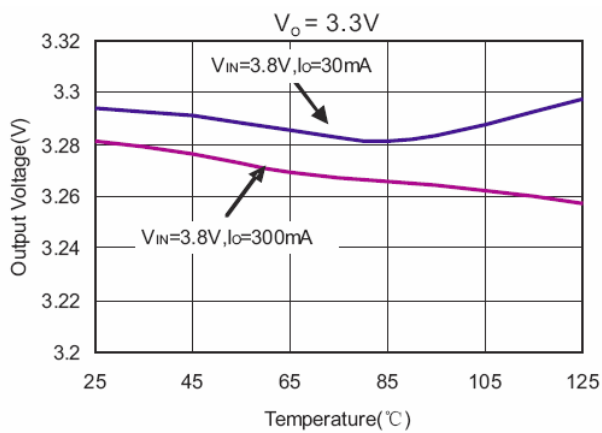
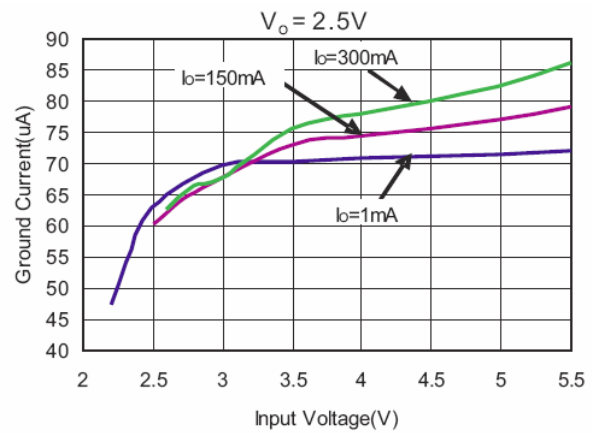
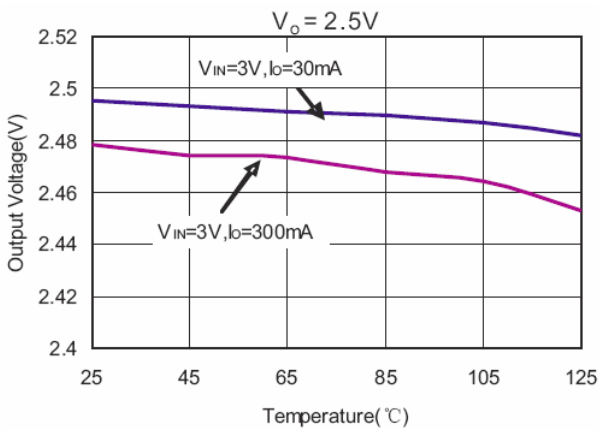
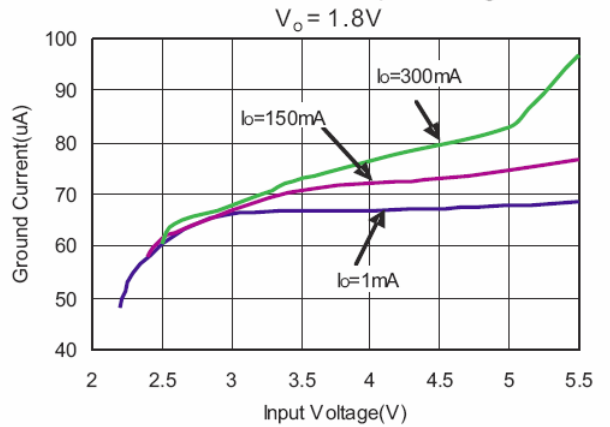

### ■ TYPICAL PERFORMANCE CHARACTERISTICS (CONTINUED)

( $V_{IN} = V_{EN}$ ,  $C_{IN} = 1\mu F$ ,  $C_O = 2.2\mu F$ ,  $C_{BYP} = 10nF$ ,  $T_A = 25^\circ C$  unless otherwise specified.)

5. Dropout Voltage vs Output Current

$V_o = 1.8V$

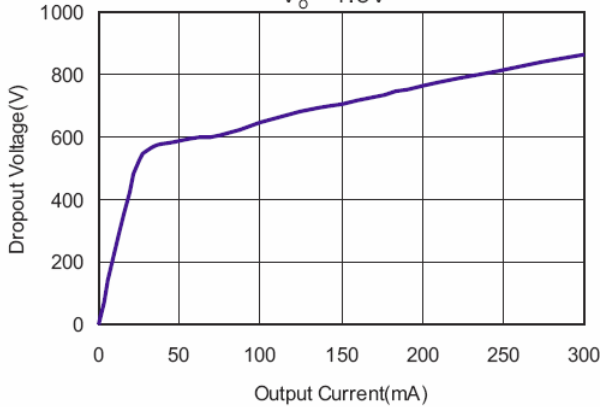

6. Dropout Voltage vs Temperature

$V_o = 1.8V, I_o = 300mA$

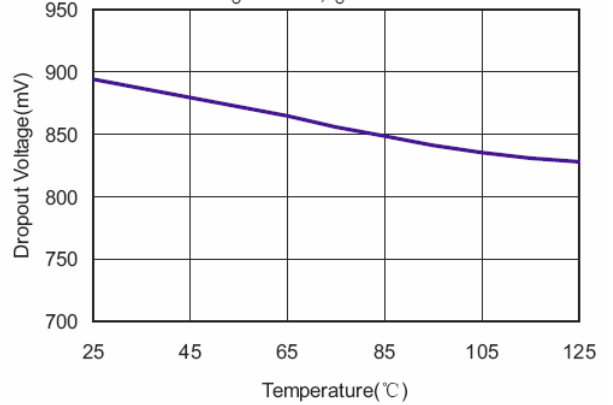

$V_o = 2.5V$

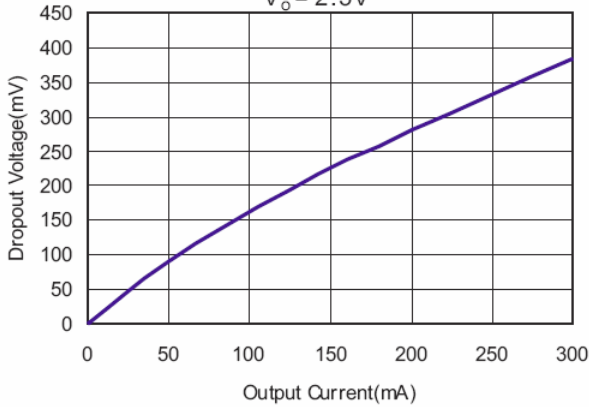

$V_o = 2.5V, I_o = 300mA$

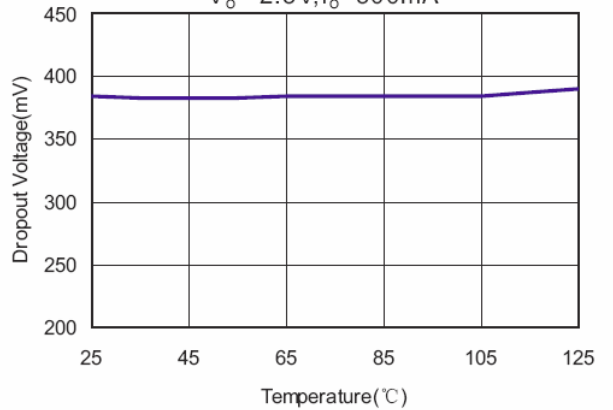

$V_o = 3.3V$

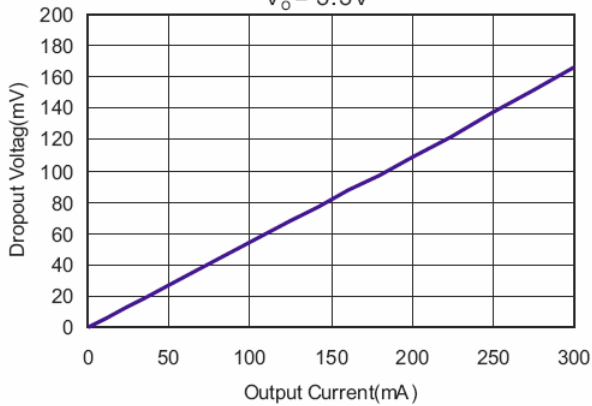

$V_o = 3.3V, I_o = 300mA$

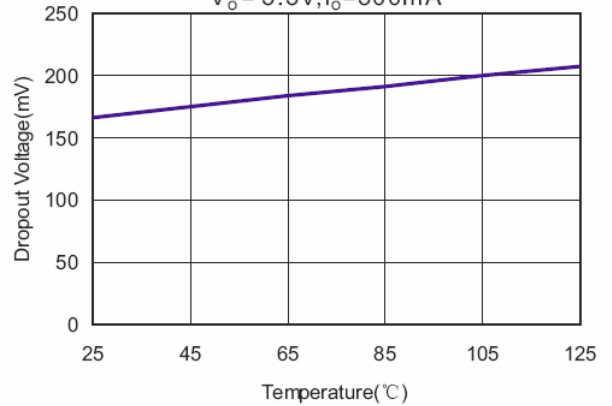

### ■ TYPICAL PERFORMANCE CHARACTERISTICS (CONTINUED)

( $V_{IN} = V_{EN}$ ,  $C_{IN} = 1\mu F$ ,  $C_O = 2.2\mu F$ ,  $C_{BYP} = 10nF$   $T_A = 25^\circ C$  unless otherwise specified.)

7. Quiescent Current vs Input Voltage  
 $V_o = 1.8V$

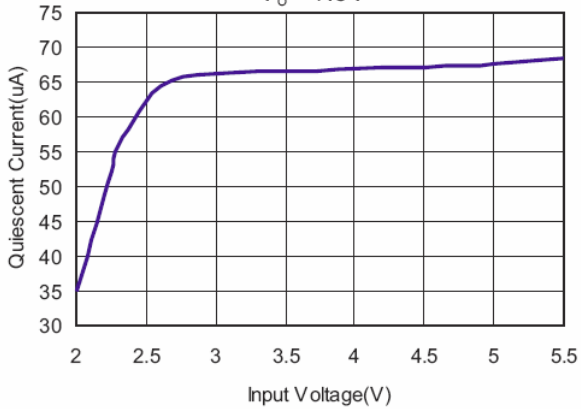

8. Quiescent Current vs Temperature  
 $V_o = 1.8V$

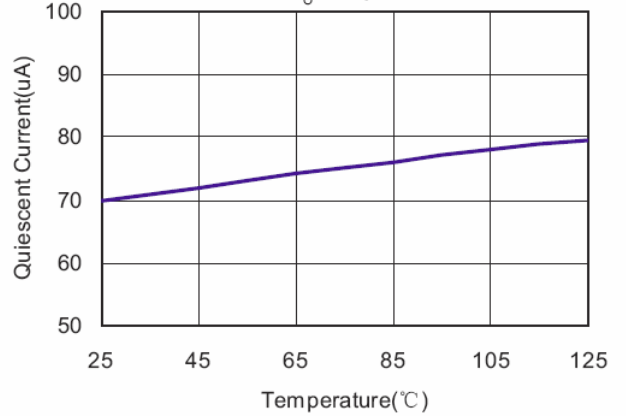

$V_o = 2.5V$

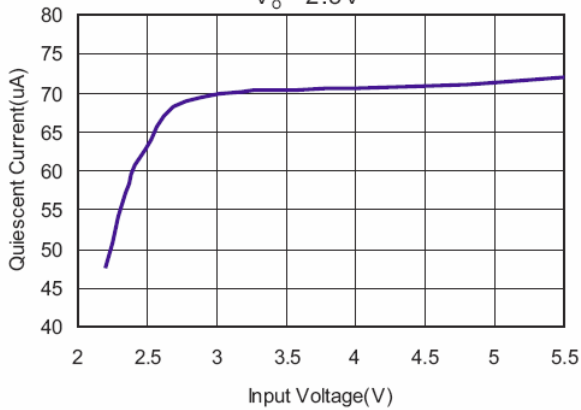

$V_o = 2.5V$

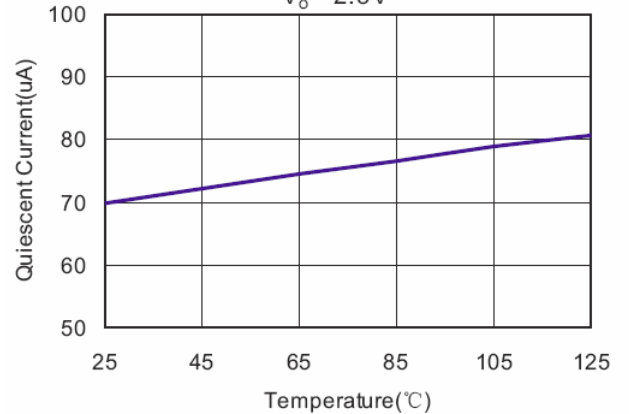

$V_o = 3.3V$

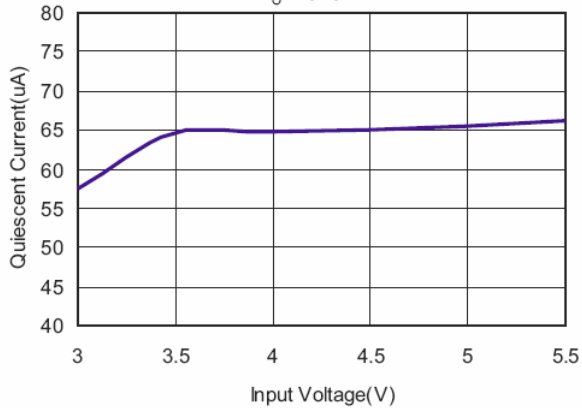

$V_o = 3.3V$

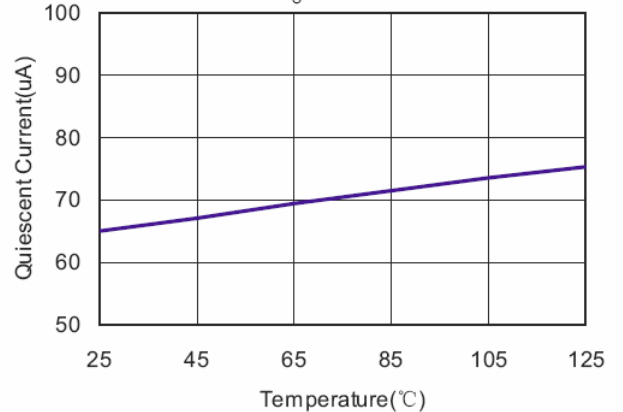



### ■ TYPICAL PERFORMANCE CHARACTERISTICS (CONTINUED)

( $V_{IN} = V_{EN}$ ,  $C_{IN} = 1\mu F$ ,  $C_O = 2.2\mu F$ ,  $C_{BYP} = 10nF$ ,  $T_A = 25^\circ C$  unless otherwise specified.)

9. Power Supply Ripple Rejection

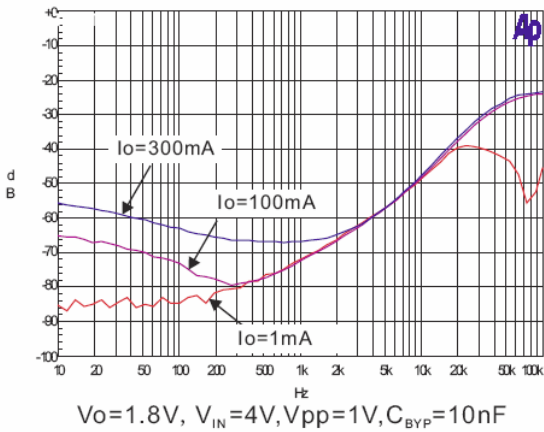
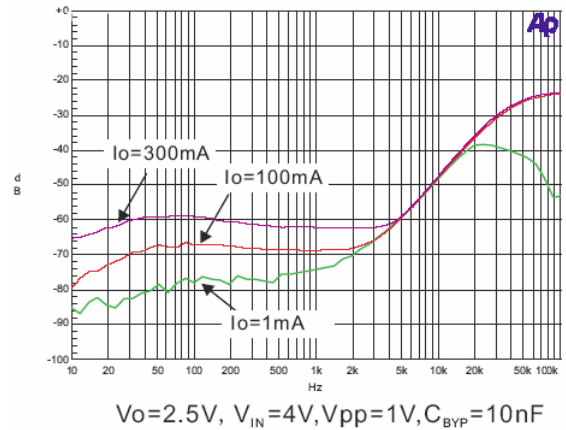
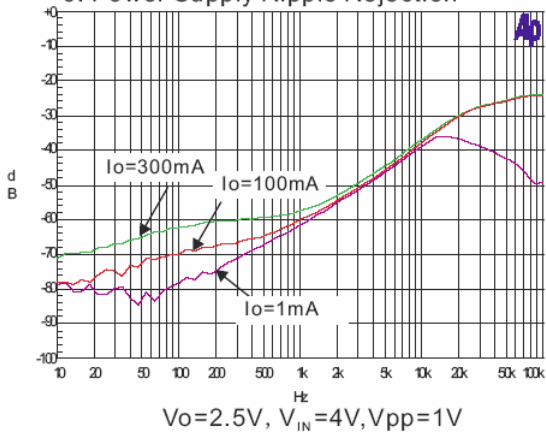

10. Load Transient Response

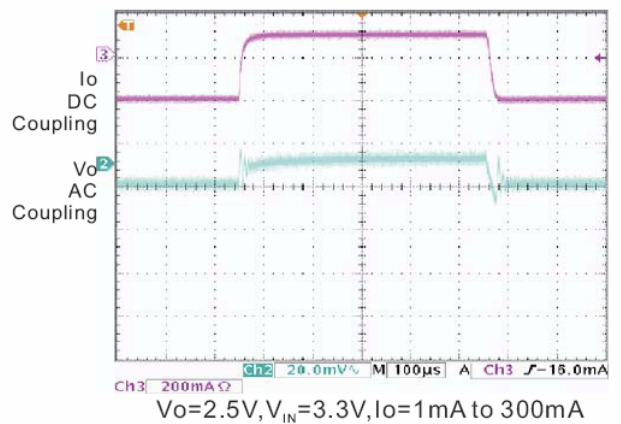

11. Line Transient Response

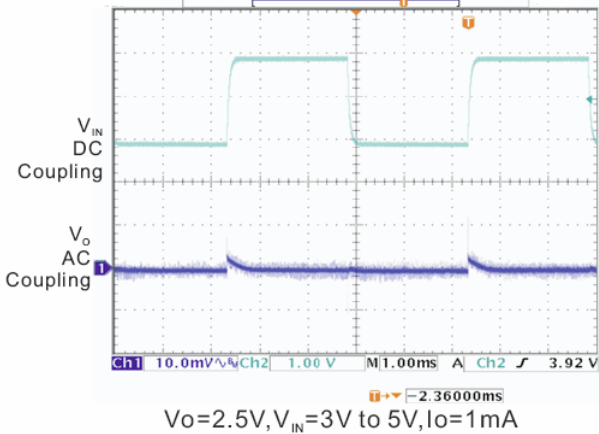

12. Turn-on Response

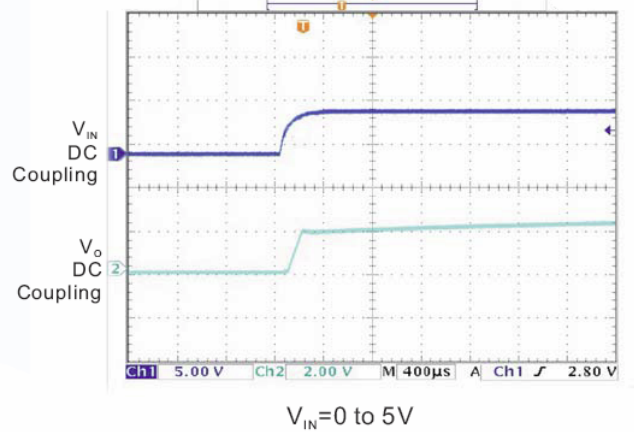

■ ORDERING INFORMATION

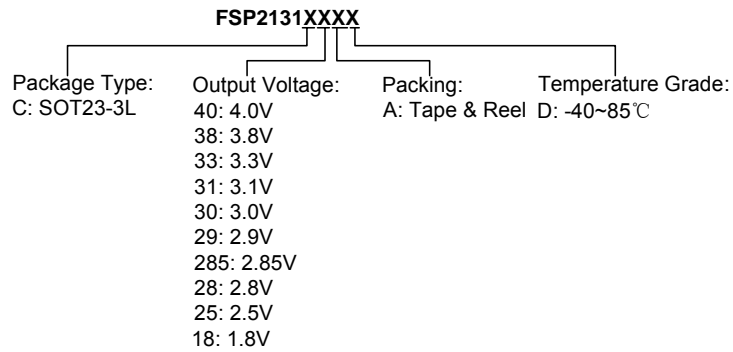

■ MARKING INFORMATION

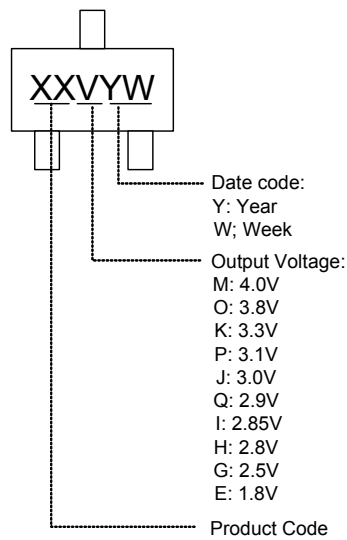

■ PACKAGE INFORMATION

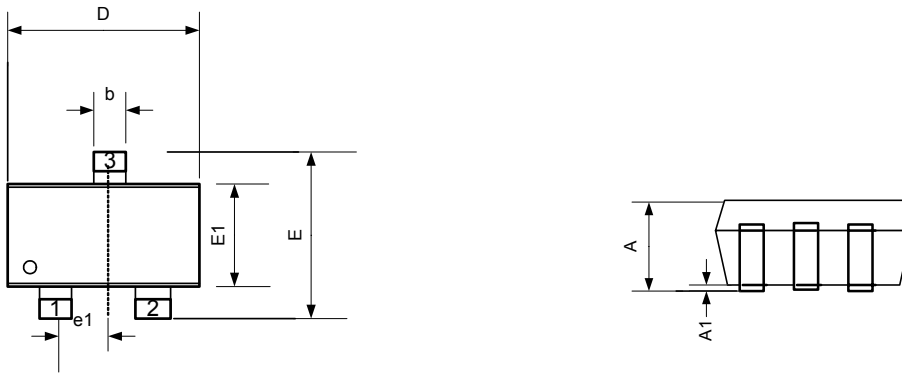

Symbol	Dimensions In Millimeters		Dimensions In Inches	
	Min.	Max.	Min.	Max.
A	0.889	1.295	0.036	0.052
A1	0.000	0.152	0.000	0.006
b	0.353	0.599	0.014	0.024
D	2.692	3.099	0.108	0.124
E	2.591	2.977	0.104	0.119
E1	1.397	1.803	0.056	0.072
e1	0.838	1.041	0.034	0.042