

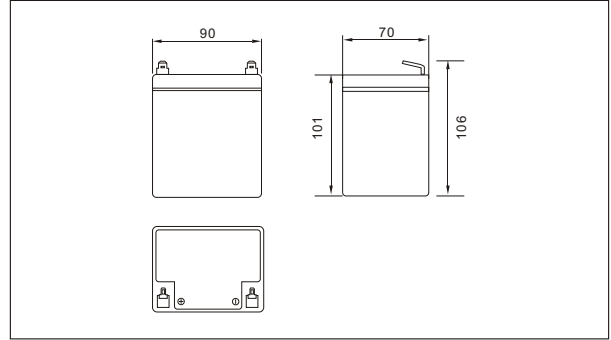

SW1240(12V4.0AH)



Outer dimensions (mm)



Specifications

Nominal Voltage		12V
Rated capacity (20hour rate)		4.0Ah
Dimensions	Total Height	106mm (4.17 inches)
	Height	101mm (3.98 inches)
	Length	90mm (3.54 inches)
	Width	70mm (2.76 inches)
Weight Approx		1.45Kg (3.19lbs)

Terminal Type (mm)

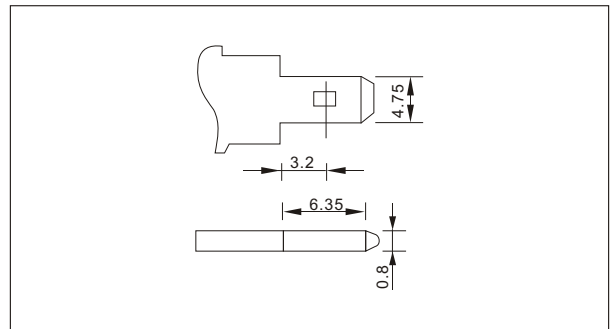

Characteristics

Capacity 25°C(77°F)	20 hour rate(0.20 A)	4.00 AH
	10 hour rate(0.37 A)	3.70 AH
	5 hour rate(0.68 A)	3.40 AH
	1 hour rate(2.40 A)	2.40 AH
	1.5 hour discharge to 10.5V	1.67 A
Internal Resistance	Full charged Battery at 25°C(77°F)	48 mΩ
Capacity affected by Temperature (20hour rate)	40°C(104°F)	102%
	25°C(77°F)	100%
	0°C(32°F)	85%
	-15°C(5°F)	65%
Self-Discharge at 25°C(77°F)	Capacity after 3 month storage	91%
	Capacity after 6 month storage	82%
	Capacity after 12 month storage	64%
Terminal		T1
Charge (constant Voltage)	Cycle	Initial Charging Current less than 1.60A Voltage 14.40-14.70V
	Float	Voltage 13.50-13.80V

Discharge Curves 25°C(77°F)

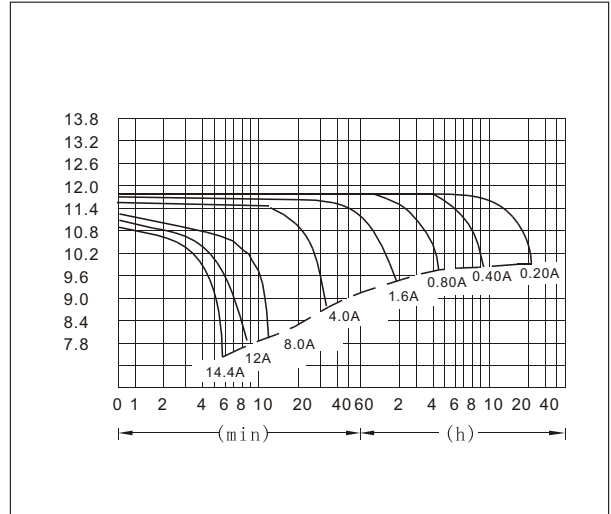

Constant Current(Amp) and Constant Power(Watt) Discharge Table at 25°C(77°F)

Time		5min	10min	15min	30min	1h	2h	3h	4h	5h	8h	10h	20h
9.60V	A	14.4	9.44	7.00	4.60	2.40	1.40	1.03	0.83	0.70	0.46	0.38	0.21
	W	150	101	75	50	26.00	15.37	11.47	9.30	7.98	5.32	4.37	2.40
10.20V	A	13.2	9.03	6.43	4.37	2.25	1.34	1.00	0.80	0.69	0.46	0.37	0.20
	W	142	101	72	49	25.50	15.48	11.58	9.30	8.02	5.32	4.37	2.37
10.50V	A	12.0	8.44	6.00	4.23	2.18	1.32	0.98	0.76	0.69	0.45	0.37	0.20
	W	132	96	69	49	25.17	15.27	11.45	8.90	7.97	5.30	4.35	2.37
10.80V	A	11.5	8.07	5.60	4.12	2.11	1.28	0.97	0.75	0.65	0.44	0.36	0.20
	W	130	93	65	48	24.50	15.03	11.40	8.82	7.68	5.20	4.27	2.32
11.10V	A	10.7	7.60	5.20	4.00	2.03	1.25	0.92	0.73	0.62	0.43	0.35	0.19
	W	121	88	61	47	23.83	14.78	10.88	8.73	7.42	5.12	4.23	2.30