

Push Switch 2.5mm-travel Horizontal Type

SPPJ2 Series



Switches with a lever height of 5.5mm, directly mountable onto sets.

Detector
Push
Slide
Rotary
Encoders
Power

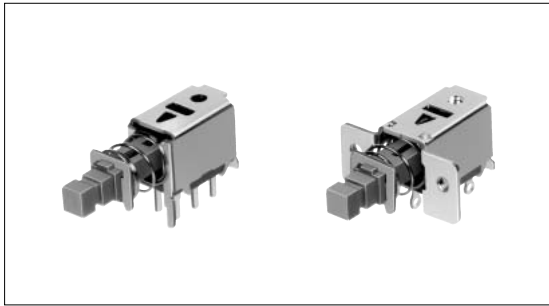

Typical Specifications

Items		Specifications
Rating (max.) (min.) (Resistive load)		0.2A 30V DC/50 μ A 3V DC
Contact resistance (Initial / After operating life)		20m max./40m max.
Operating force		3 \pm 1.5N
Operating life	Without load	10,000cycles
	With load	10,000cycles(0.2A 30V DC)

Product Line

Changeover timing	Travel (mm)	Total travel (mm)	Rating	Mounting method	Poles	Operation	Terminal type	Minimum order unit (pcs.)	Product No.	Drawing No.
Non shorting	2.5	3.5		PC board	2	Latching	For PC board	3.500	SPPJ222200	1
						Momentary			SPPJ223200	
				M2-screw		Latching	Lead	2.500	SPPJ225800	2
						Momentary			SPPJ226400	

Dimensions

Unit:mm

No.	Style	PC board mounting hole dimensions (Viewed from the direction A)
1	<p>For PC board</p>	
2	<p>Lead</p>	

Notes

1. Products other than those listed in the above chart are also available. Please contact us for details.
2. Please place purchase orders per minimum order unit (integer).

Refer to P.107 for knobs.

Actuator Configuration at Front Edge Unit:mm

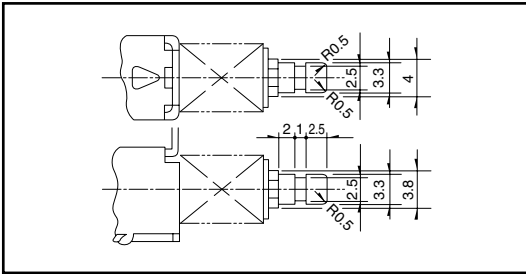

Terminal Configuration Unit:mm

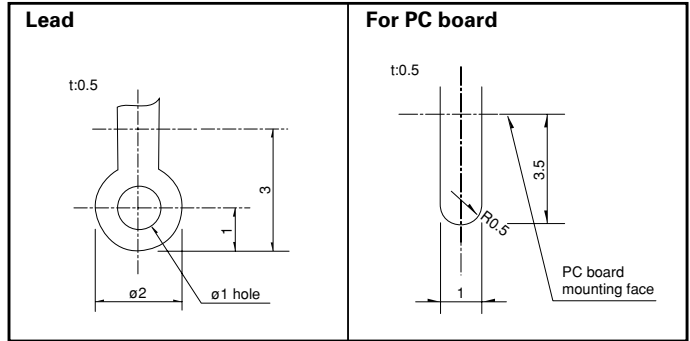

Circuit Diagram (Viewed from Direction A)

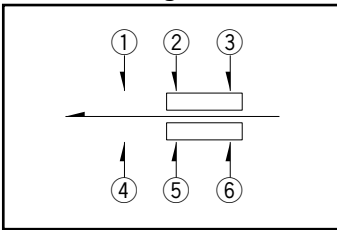

Detector

Push

Slide

Rotary

Encoders

Power

Dual-in-line
Package Type

TACT Switch™

Custom-
Products

**Horizontal
Type**

Vertical
Type

List of Varieties

Series		SPEE	SPPJ6	SPPJ3	SPPJ2	SPUJ 1	SPUP 1	SPUN	SPUN medium current 1	SPEG	SPPH2		
Detector	Photo												
Push	Travel (mm)	0.3 0.71	1.5	2.5		2	1.5 2	2.5			1		
Slide	Total travel (mm)	0.9	2.5	3.5		3	2.5 3	3.5		1.2	1.5		
Rotary	Number of poles	1	2	1 2	2	2 4				1	2		
Encoders	Dimensions (mm)	W	4	9		6.6		7.2	7.5		10	7.15	6.5
Power		D	5	12		15.2 22.7		24 36		8.35	6		
Dual-in-line Package Type		H	1.22	4.5	8.3	9.6	8.8	10.3	13		3.5	6.5	
TACT Switch™	Operating temperature range	- 10°C to + 60°C		- 40°C to + 85°C		- 10°C to + 60°C							
Custom-Products	Rating (max. χ Resistive load)	20mA 5V DC	0.2mA 5V DC	0.2mA 30V DC		0.1mA 30V DC			1A 25V DC	50mA 16V DC	0.1A 12V DC		
	Rating (min. χ Resistive load)	100 μ A 3V DC	50 μ A 3V DC							50 μ A 3V DC			
Horizontal Type	Electrical performance	Initial contact resistance	2	20m max.						200m max.	30m max.		
		Insulation resistance	10M min. 100V DC	100M min. 500V DC						3M min. 100V DC	100M min. 500V DC		
		Voltage proof	100V AC for 1minute	500V AC for 1minute						100V AC for 1minute	500V AC for 1minute		
Vertical Type	Mechanical performance	Terminal strength	5N for 1minute								0.5N for 1minute	5N for 1minute	
		Actuator strength	Operating direction 50N		30N		50N				50N	30N	
Durability	Durability	Operating life without load	100,000 cycles	10,000cycles 40m max.				30,000cycles 40m max.	10,000cycles 40m max.	35,000cycles 500m max.	10,000cycles 50m max.		
		Operating life without load Load:as rating	100,000 cycles	10,000cycles 40m max.				5,000cycles 40m max.					
Environmental performance	Environmental performance	Cold	-40 \pm 2 for 96h	-20 \pm 2 for 96h						-20 \pm 2 for 96h			
		Dry heat	85 \pm 2 for 96h								85 \pm 2 for 96h		
		Damp heat	40 \pm 2 , 90 to 95%RH for 96h								40 \pm 2 , 90 to 95%RH for 96h		
Soldering	Soldering	Manual soldering	350 \pm 10 4 ⁺¹ ₀ s	350 \pm 10 3 ⁺¹ ₀ s		300 \pm 10 3 ⁺¹ ₀ s		350 \pm 10 3 ⁺¹ ₀ s		350 \pm 5 3s max.	350 max. 3s max.		
		Dip soldering		260 \pm 5 5 \pm 1s	260 \pm 5 10 \pm 1s	260 \pm 5 5 \pm 1s		260 \pm 5 10 \pm 1s			260 \pm 5 5 \pm 1s		
		Reflow soldering	Please see P.108									Please see P.108	
	Page	84	85	86	88	90	91	92		94	96		

Push Switches Attached Parts	107
Soldering Conditions	108
Push Switches Products Caution	109

Notes

- ※1. The operating temperature range for automotive applications can be raised upon request. Please contact us for requirements of this kind.
- ※2. 1V or less, at the present rating of 1mA, 5V DC for output voltage.

Attached Parts

Please specify required knob.

Unit:mm

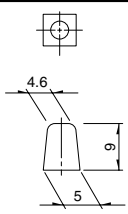
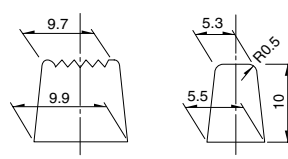
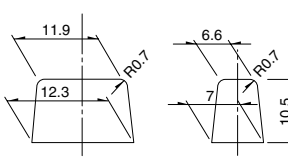
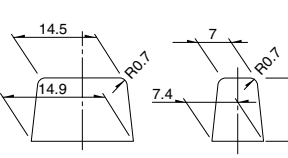
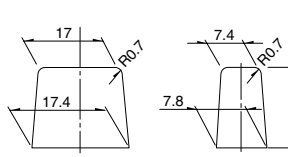
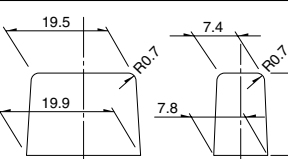
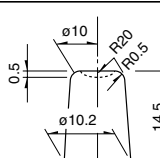
Knob outline drawing	Variety		Series
	Color	Model	
	Black Red White	UJ206022 UJ206020 UJ206026	SPPJ3 SPUJ
<p>Key pitch 10mm</p> <p>Square knob</p> 		4093-1 4093-2 4093-3	
<p>Key pitch 12.5mm</p> <p>Square knob</p> 		UE201011 UE201012 UE201013	
<p>Key pitch 15mm</p> <p>Square knob</p> 		UE202011 UE202012 UE202013	SPPJ2 SPUP SPUN SPEC
<p>Key pitch 17.5mm</p> <p>Square knob</p> 		UE203011 UE203012 UE203013	
<p>Key pitch 20mm</p> <p>Square knob</p> 		UE204011 UE204012 UE204013	
<p>Round knob</p> 		UE200011 UE200012 UE200013	

Detector

Push

Slide

Rotary

Encoders

Power

Dual-in-line
Package Type

TACT Switch™

Custom-
Products

Horizontal
Type

Vertical
Type

Note

We recommend the use of adhesive to secure the knob when mounting onto switches.

