

Sirenza Microdevices' SPB-2026Z is a high linearity single-stage class AB Heterojunction Bipolar Transistor (HBT) amplifier housed in a surface-mountable plastic encapsulated package. This HBT amplifier is made with InGaP on GaAs device technology and fabricated with MOCVD for an ideal combination of low cost and high reliability.

This product is well suited for use as a driver stage in macro/micro-cell infrastructure equipment or as the final output stage in pico-cell infrastructure equipment. It can run from a 3V to 6V supply. It is pre-matched to ~5 ohms on the input for broadband performance and ease of matching at the board level. It features an input power detector, on/off power control, ESD protection, excellent overall robustness and a hand reworkable and thermally enhanced SOF-26 package. This product is RoHS and WEEE compliant.

**Functional Block Diagram**

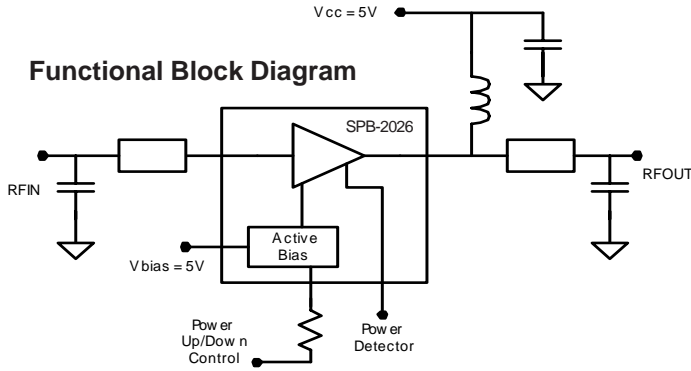

Preliminary

## SPB-2026Z

### 1.7-2.2GHz 2W InGaP Amplifier

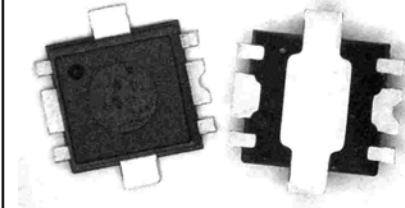

SOF-26 Package



### Product Features

- P1dB = 33.8dBm @ 5V, 1960 MHz
- ACP = -45dBc with 25 dBm Ch. Pwr. @ 1960 MHz
- On-chip Input Power Detector
- Low Thermal Resistance Package
- Power up/down control < 1µs
- Robust Class 1C ESD

### Applications

- Macro/Micro-Cell driver stage
- Pico-Cell output stage
- GSM, CDMA, TDSCDMA, WCDMA
- Single and Multi-Carrier applications

Symbol	Parameters	Units	Frequency	Min.	Typ.	Max.
S <sub>21</sub>	Small Signal Gain	dB	1842 MHz		13.6	
			1960 MHz	12.2	13.7	15.2
			2140 MHz	12.1	13.6	15.1
P <sub>1dB</sub>	Output Power at 1 dB Compression	dBm	1842 MHz		33.9	
			1960 MHz		33.8	
			2140 MHz	31.3	32.8	
IM <sub>3</sub>	Third Order Suppression 22 dBm per tone, 1MHz spacing	dBc	1842 MHz		-49	
			1960 MHz	-42	-45	
			2140 MHz		-48	
Channel Power	WCDMA Channel Power tested with 64 Channels FWD	dBm	1842MHz		23	
					25	
		dBm	1960MHz		23	
					25	
dBm	2140MHz		22			
			25			
S <sub>11</sub>	Input Return Loss	dB	1960 MHz	16	21	
S <sub>22</sub>	Output Return Loss	dB	1960 MHz	8	12	
NF	Noise Figure	dB	1960 MHz		5.2	6.2
V <sub>det</sub> Range	Voltage Range for CW Pout=13dBm to 33dBm	V			0.85 to 1.4	
I <sub>CO</sub>	Quiescent Current (V <sub>cc</sub> = 5V)	mA		395	445	485
IVPC	Power Up Control Current (V <sub>pc</sub> = 5V)	mA			2.1	
I <sub>leak</sub>	V <sub>cc</sub> Leakage Current (V <sub>cc</sub> = 5V, V <sub>pc</sub> = 0V)	µA				10
R <sub>TH, j-l</sub>	Thermal Resistance (junction - lead)	°C/W			12	

**Test Conditions:** V<sub>cc</sub> = 5V I<sub>CO</sub> = 445mA Typ. T<sub>L</sub> = 25°C Z<sub>S</sub> = Z<sub>L</sub> = 50 Ohms

The information provided herein is believed to be reliable at press time. Sirenza Microdevices assumes no responsibility for inaccuracies or omissions. Sirenza Microdevices assumes no responsibility for the use of this information, and all such information shall be entirely at the user's own risk. Prices and specifications are subject to change without notice. No patent rights or licenses to any of the circuits described herein are implied or granted to any third party. Sirenza Microdevices does not authorize or warrant any Sirenza Microdevices product for use in life-support devices and/or systems. Copyright 2006 Sirenza Microdevices, Inc.. All worldwide rights reserved.

<b>Absolute Maximum Ratings</b>	
Parameter	Absolute Limit
Max Device Current ( $I_{CE}$ )	1500 mA
*Max Device Voltage ( $V_{CC}$ )	7 V
Power Dissipation	6 W
Max. RF Input Power with 50 ohm output load	28 dBm
Max. RF Input Power with 10:1 VSWR output load	23 dBm
Max. RF Output Power with 50 ohm output load (Continuous long term operation)	30dBm
Max. Junction Temp. ( $T_J$ )	+150°C
Operating Temp. Range ( $T_L$ )	-40°C to +85°C
Max. Storage Temp.	+150°C

Operation of this device beyond any one of these limits may cause permanent damage. For reliable continuous operation, the device voltage and current must not exceed the maximum operating values specified in the table on page one.

Bias Conditions should also satisfy the following expression:  
 $I_D V_D < (T_J - T_L) / R_{TH}, j-l \quad T_L = T_{LEAD}$

**\*Note:** No RF Drive

<b>Reliability &amp; Qualification Information</b>	
Parameter	Rating
ESD Rating - Human Body Model (HBM)	Class 1C
Moisture Sensitivity Level	MSL1

This product qualification report can be downloaded at  
[www.sirenza.com](http://www.sirenza.com)



**Caution: ESD sensitive**  
 Appropriate precautions in handling, packaging and testing devices must be observed.

**Pin Out Description**

Pin #	Function	Description
1	VBIAS	This is the supply voltage for the active bias circuit.
2	RFIN	This is the RF input pin and has a DC voltage present. An external DC block is required.
3	VPC	Power up/down control pin. The voltage on this pin should never exceed the voltage on pin 1 by more than 0.5V unless the supply current from pin 3 is limited < 10mA.
4	VDET	This is the output port for the power detector. It samples the power at the input of the amplifier.
5	RFOUT/VCC	This is the RF output pin and DC connection to the collector.
6	NC	Not connected
GND	GND	These pins are DC connected to the backside paddle. They provide good thermal connection to the backside paddle for hand soldering and rework. Many thermal and electrical GND vias are required as shown in the recommended land pattern.

**Simplified Device Schematic**

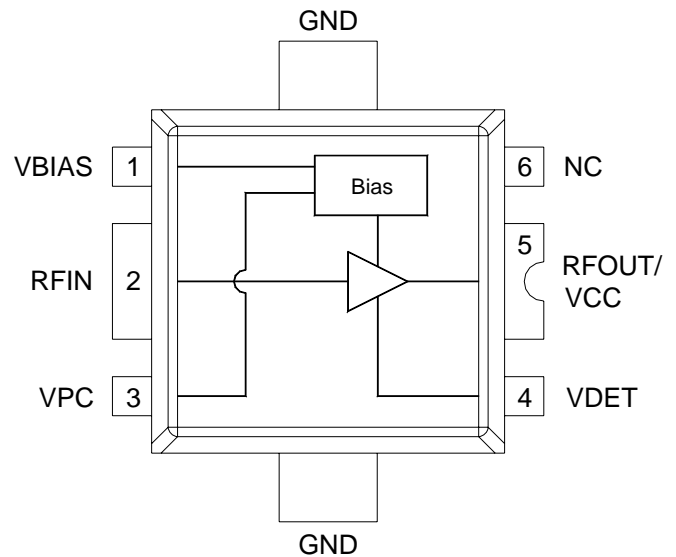

**Typical RF Performance (1805 - 1880MHz Application Circuit)**

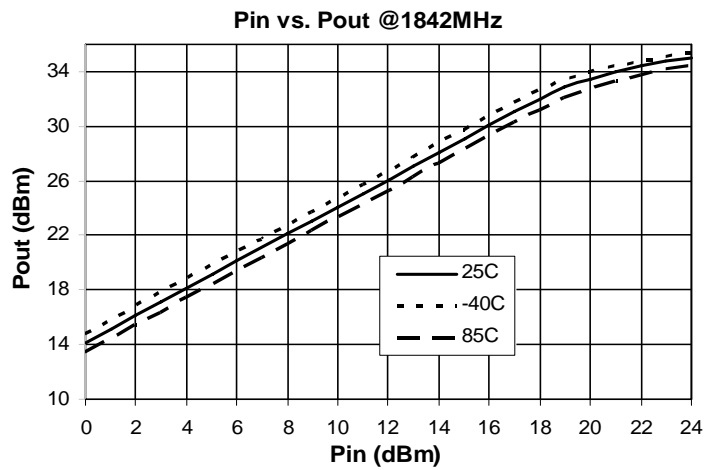
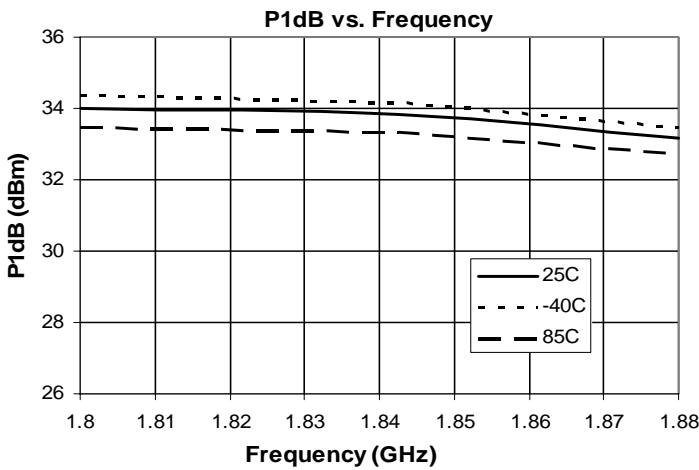
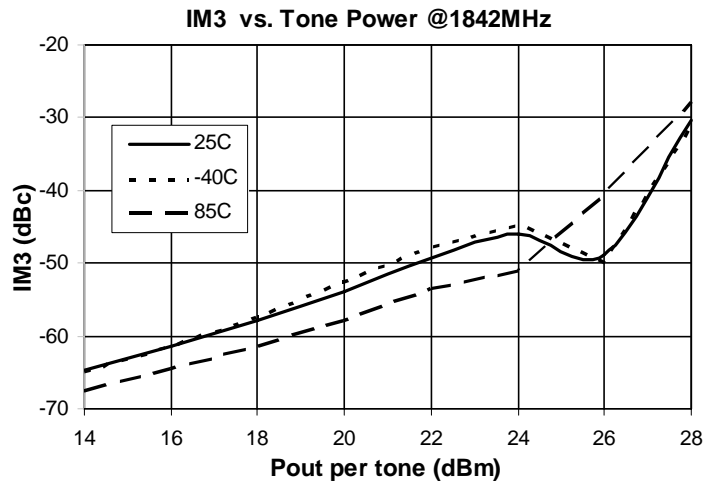
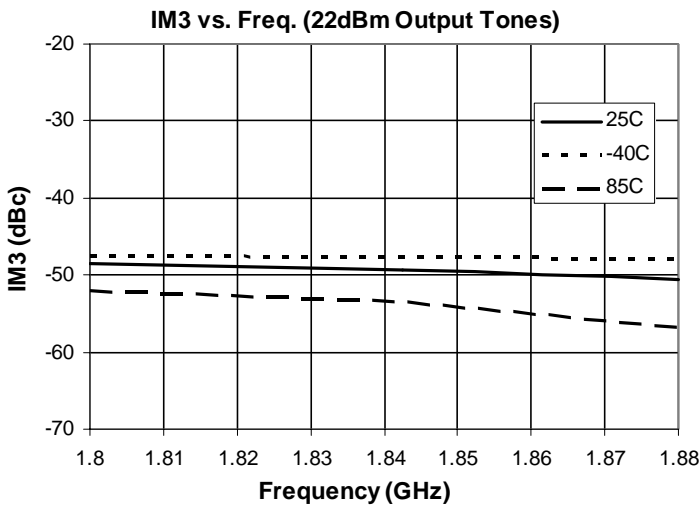
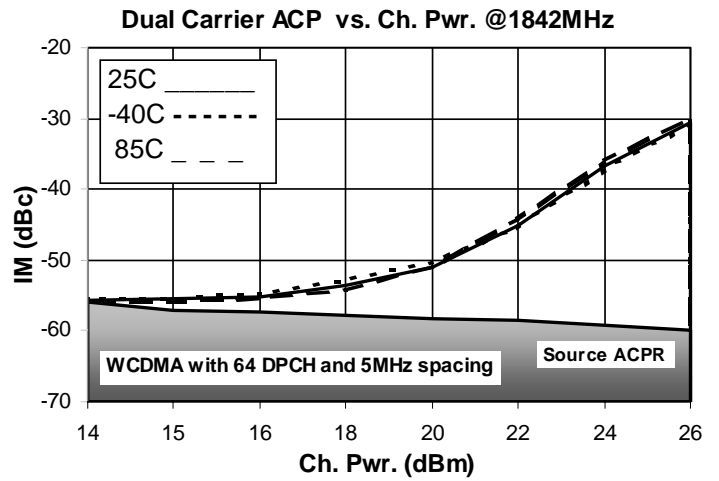
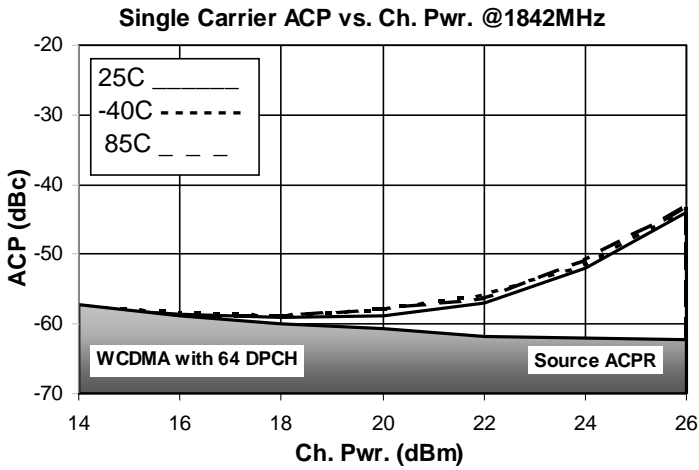

**Typical RF Performance (1805 - 1880MHz Application Circuit)**

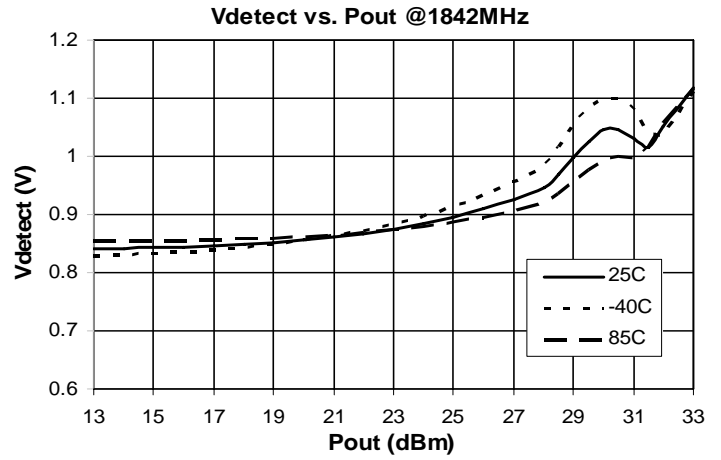
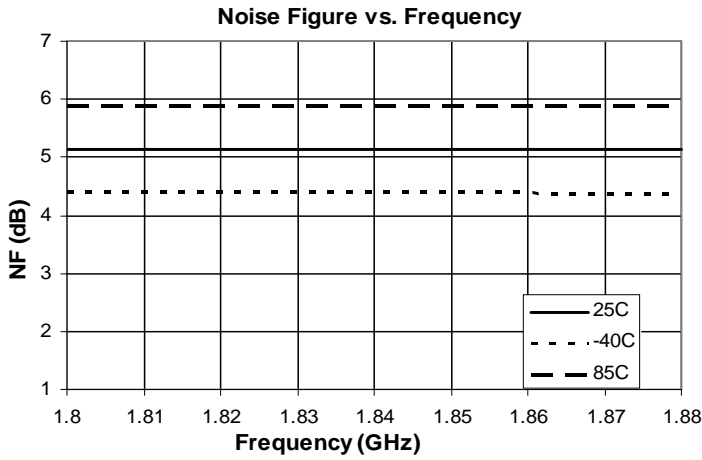

**S-Parameters over Temperature (1805 - 1880MHz Application Circuit)**

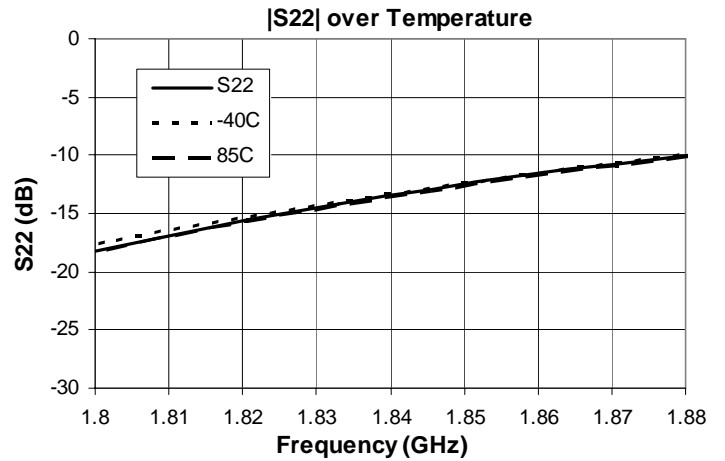
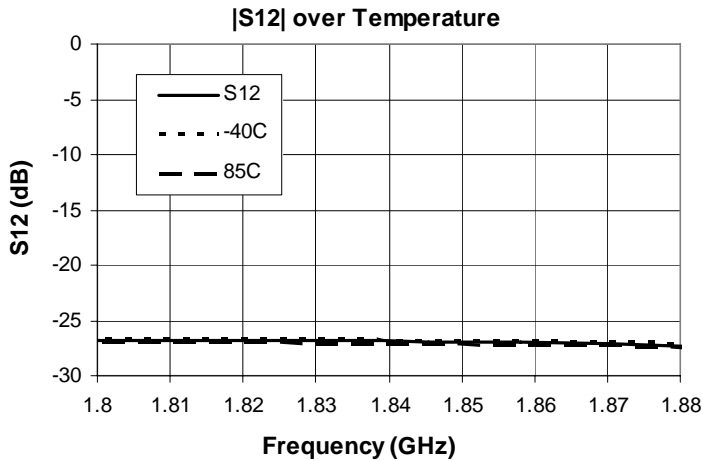
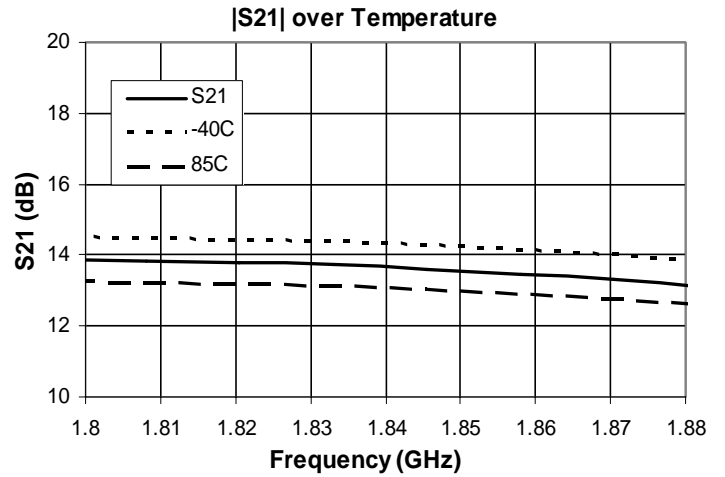
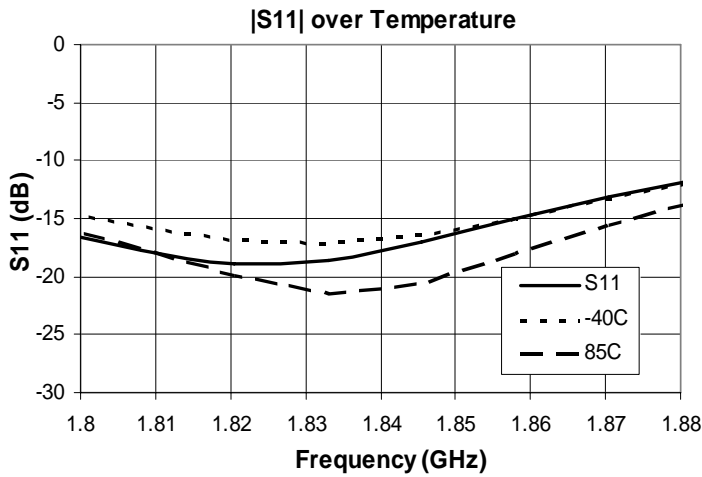

**Typical RF Performance (1930 - 1990MHz Application Circuit)**

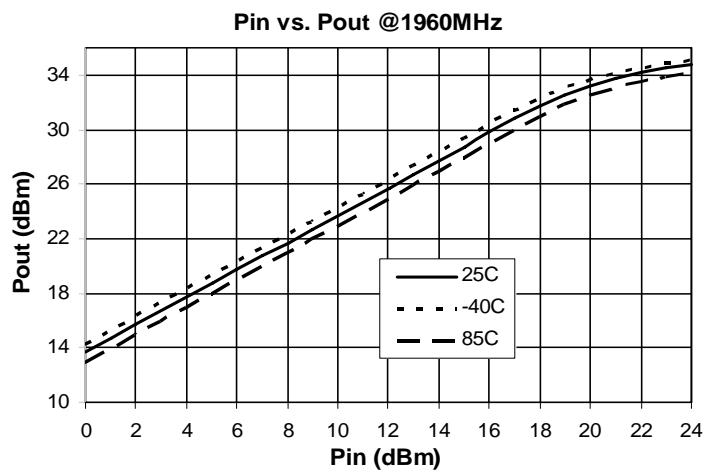
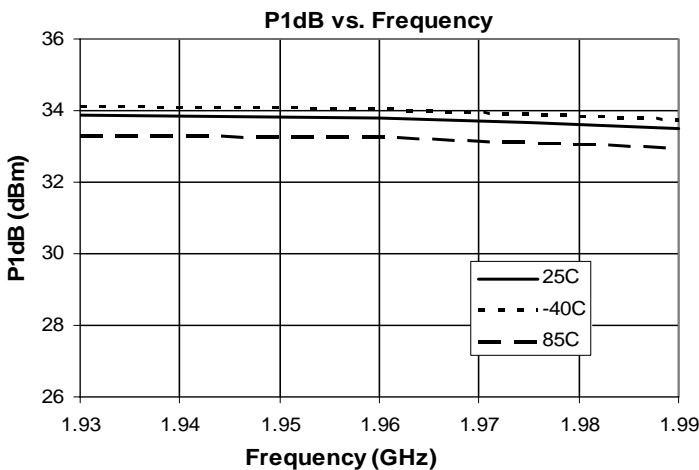
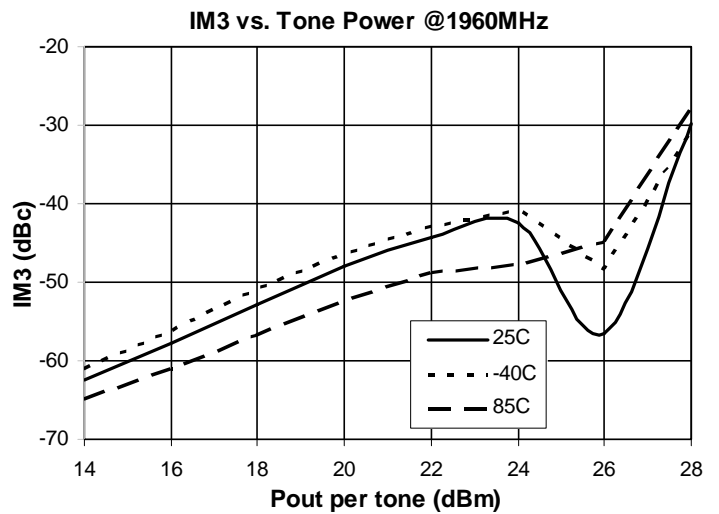
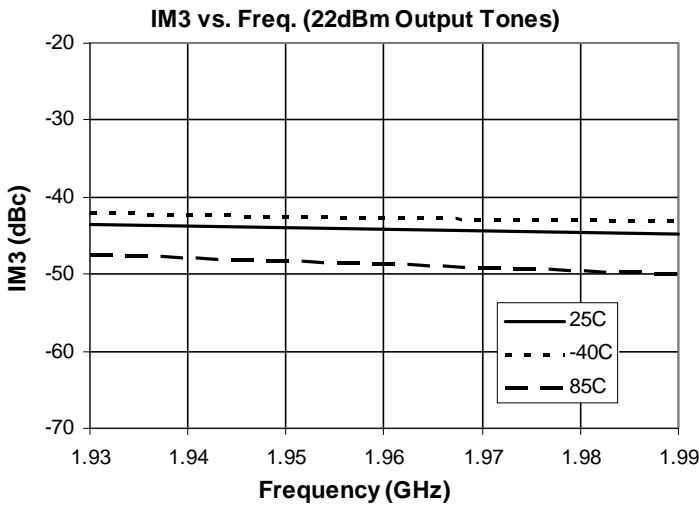
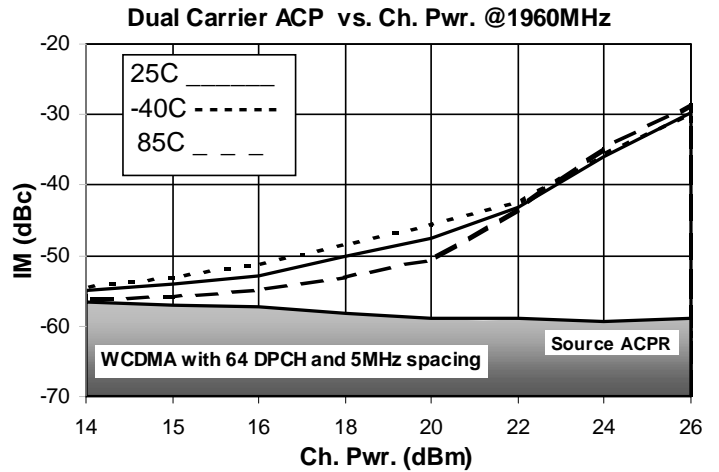
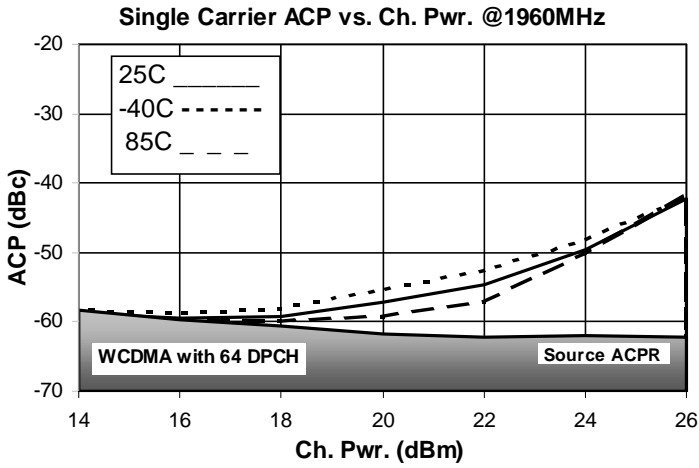

**Typical RF Performance (1930 - 1990MHz Application Circuit)**

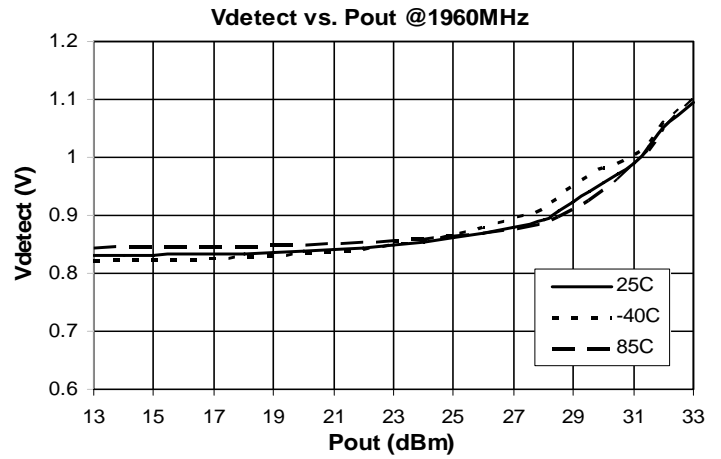
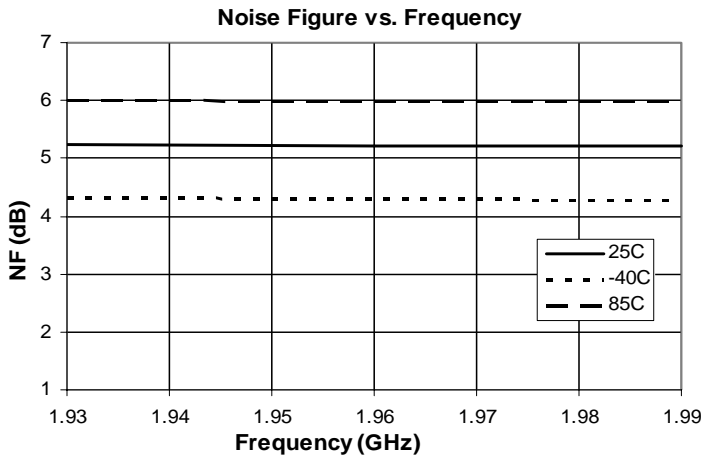

**S-Parameters over Temperature (1930 - 1990MHz Application Circuit)**

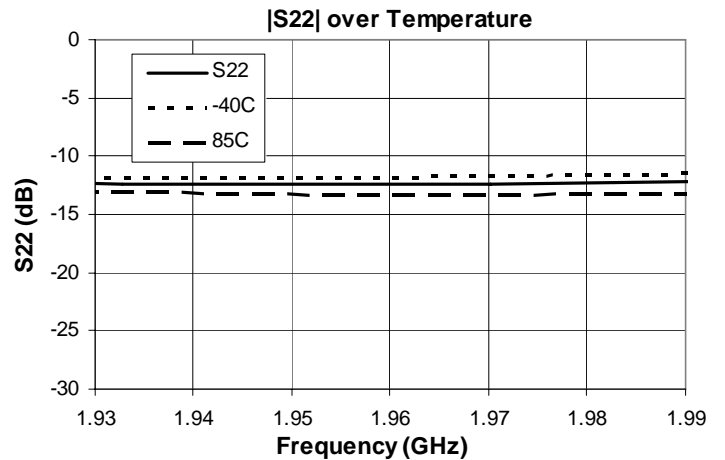
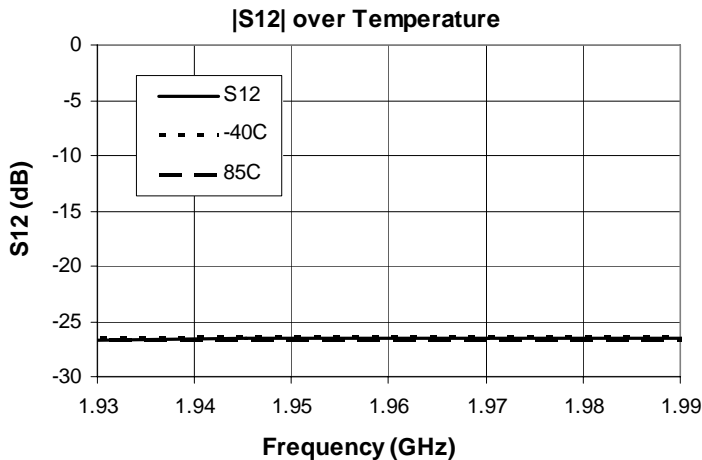
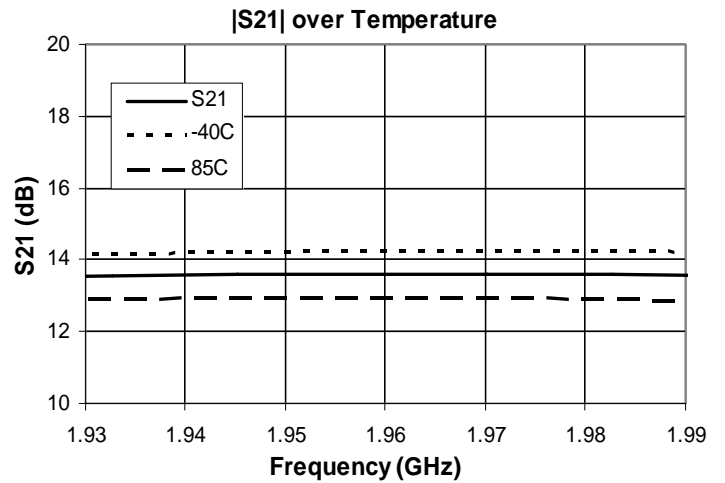
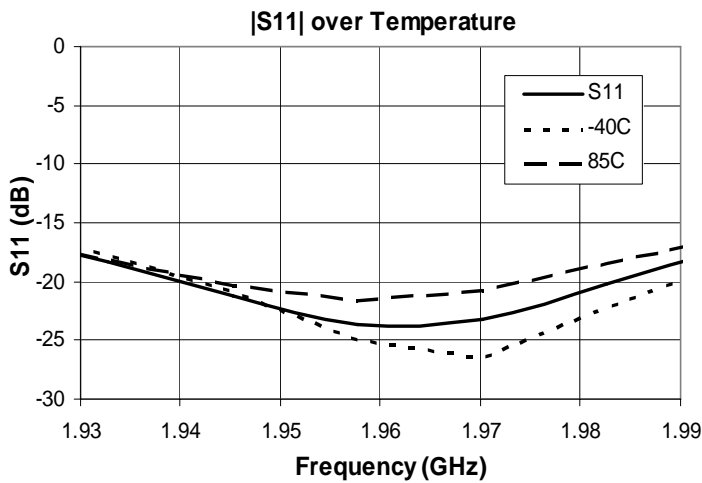

**Typical RF Performance (2110 - 2170MHz Application Circuit)**

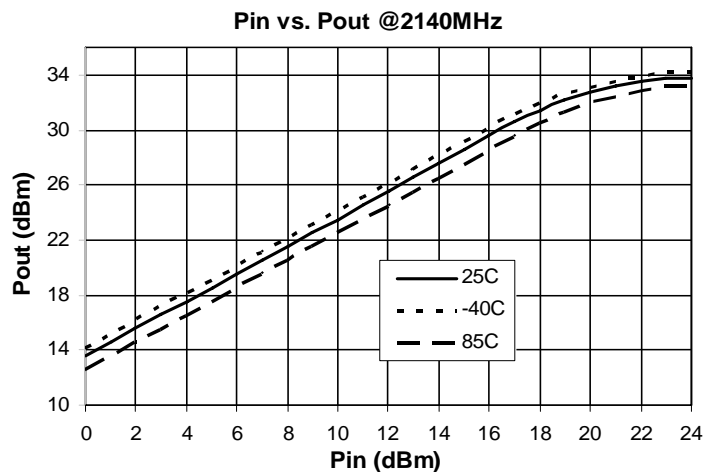
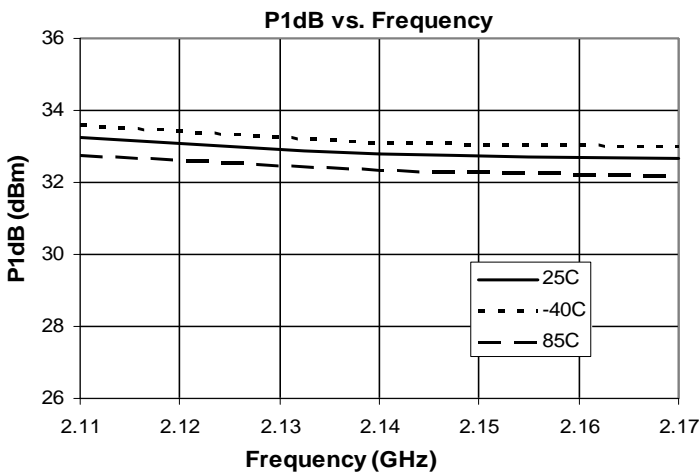
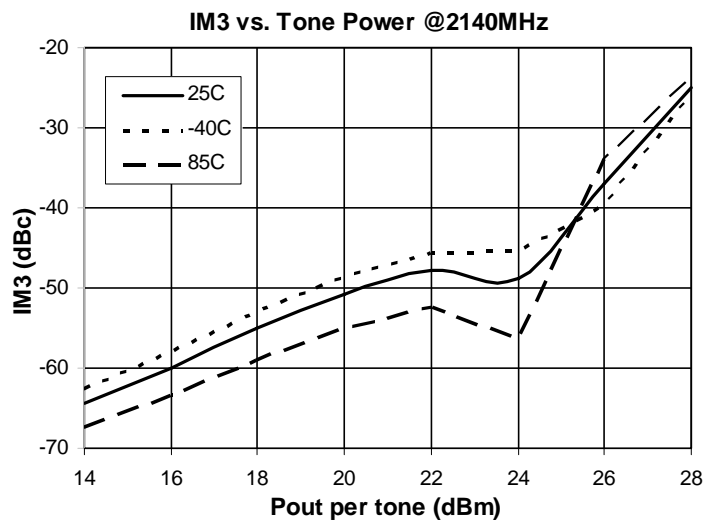
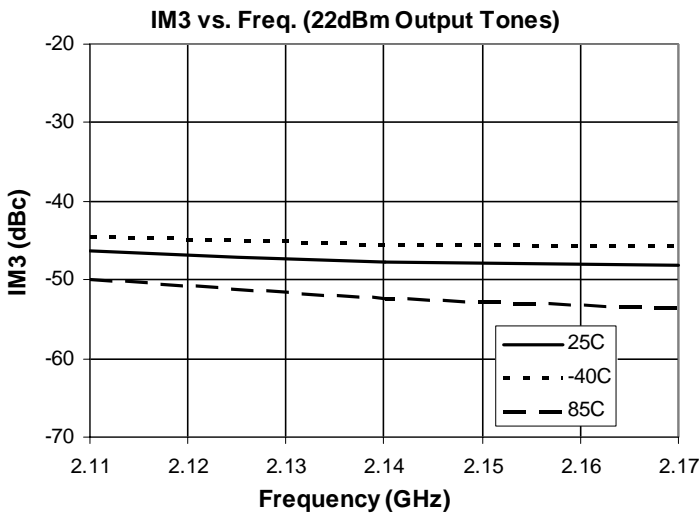
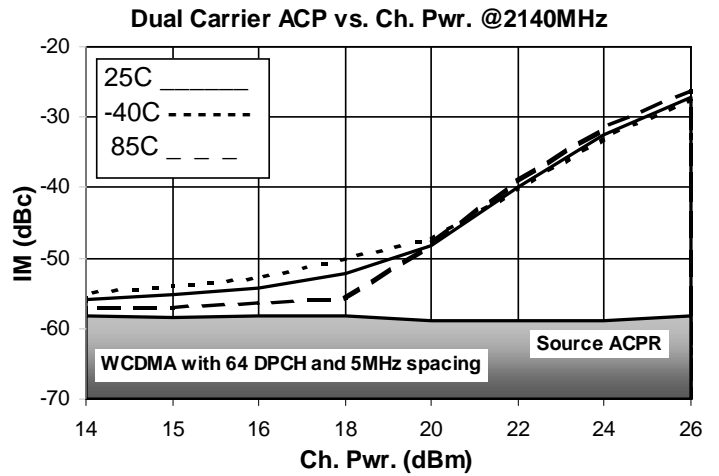
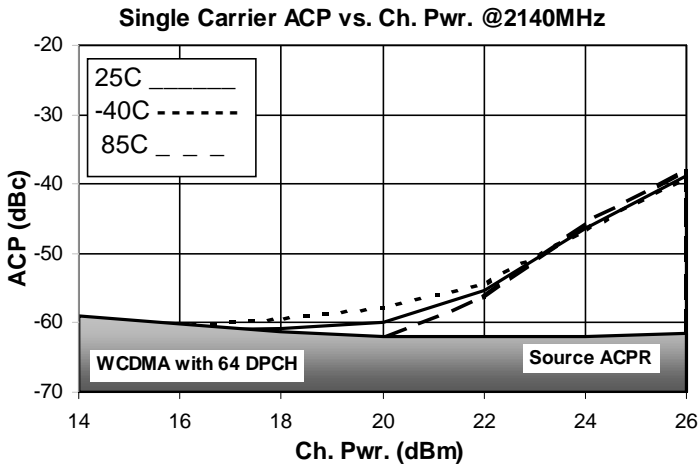

**Typical RF Performance (2110 - 2170MHz Application Circuit)**

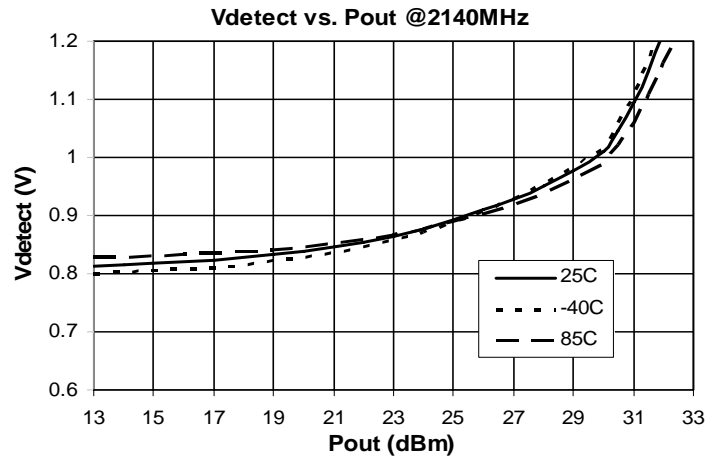
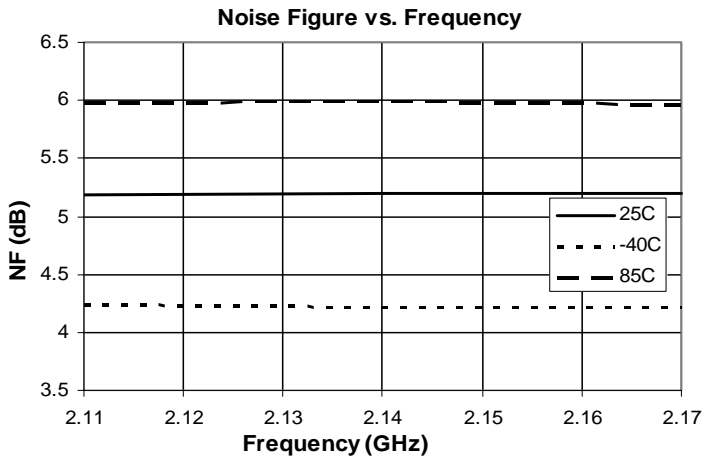

**S-Parameters over Temperature (2110 - 2170MHz Application Circuit)**

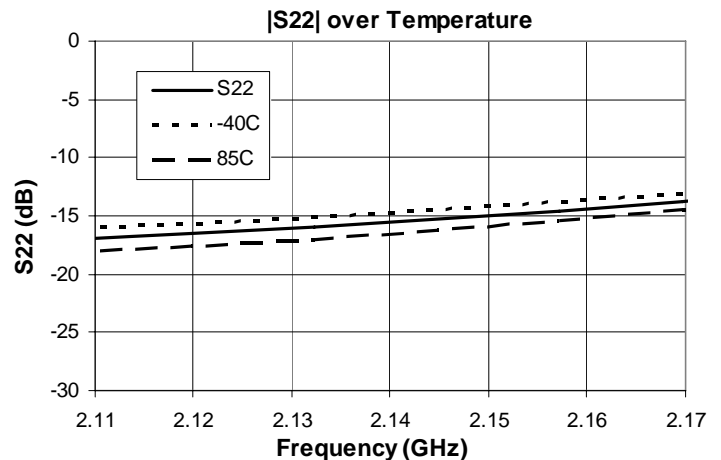
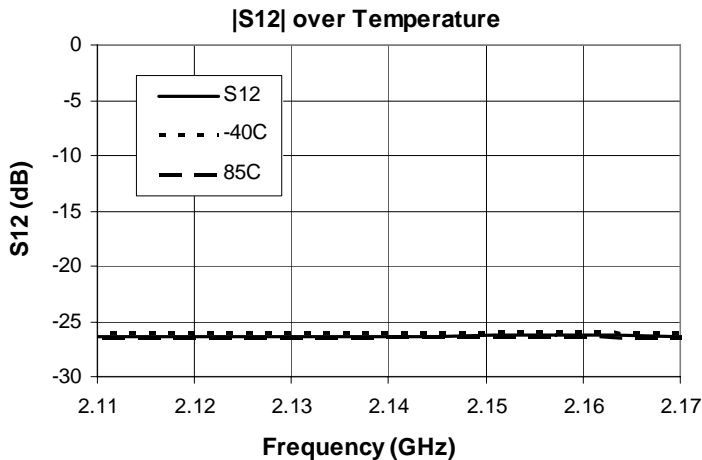
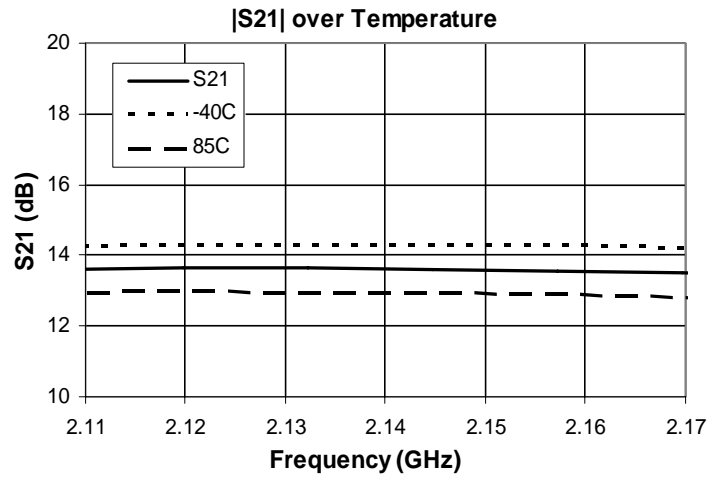
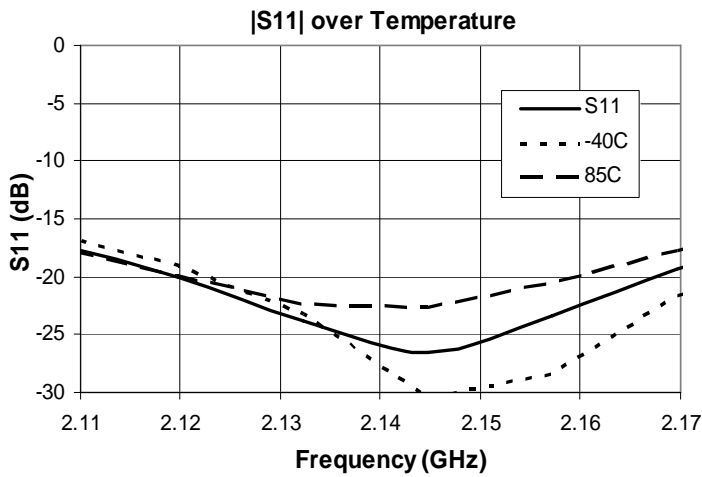



**1805 - 1880MHz Application Circuit (Vcc & Vpc = 5.0V)**

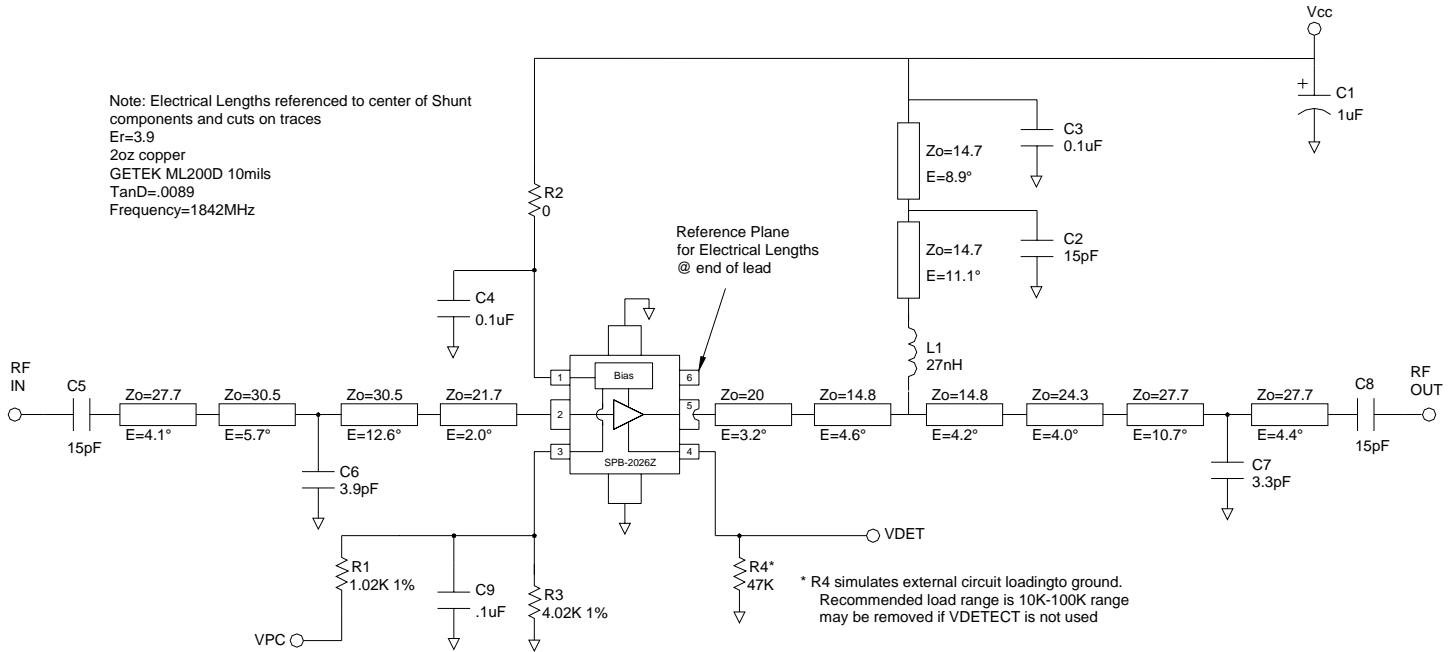

**1805 - 1880MHz Evaluation Board Layout (Vcc & Vpc = 5.0V)**

Board material GETEK, 10mil thick, Er=3.9, 2 oz. copper

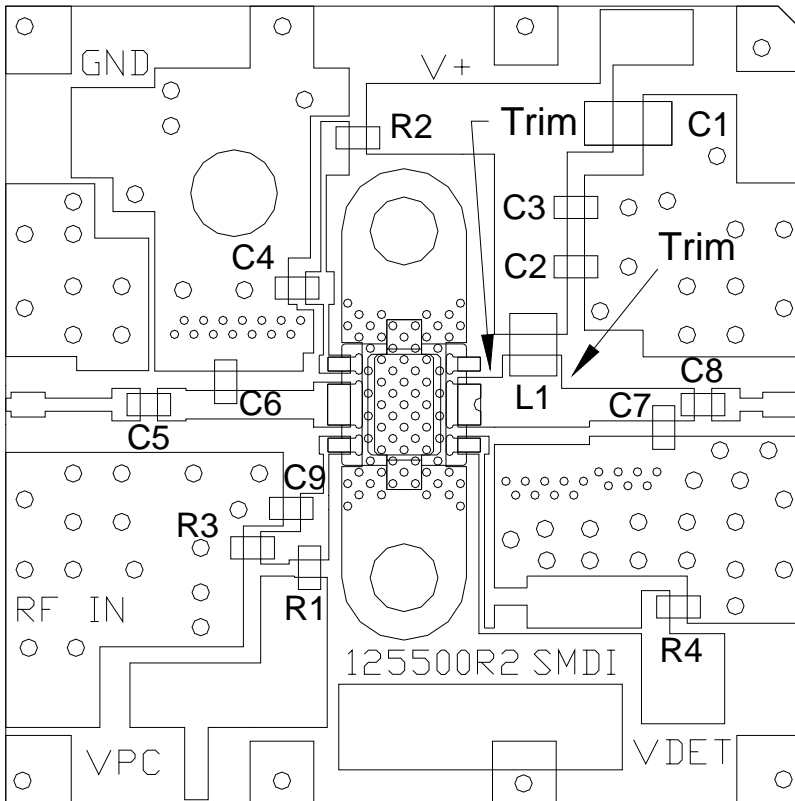

DESG	DESCRIPTION
Q1	SPB-2026Z
R1	1.02K OHM, 0603 1%
R2	0 OHM, 0603
R3	4.02K OHM, 0603 1%
R4	47K OHM, 0603
C1	1uF Tant.
C2	15pF CAP, 0603 AVX
C3,C4,C9	0.1uF CAP, 0603
C5	15pF CAP, 0603 AVX
C6	3.9pF CAP, 0603 AVX
C7	3.3pF CAP, 0603 AVX
C8	15pF CAP, 0603 AVX
L1	27nH IND, CC 0805HQ

**1930 - 1990MHz Application Circuit (Vcc & Vpc = 5.0V)**

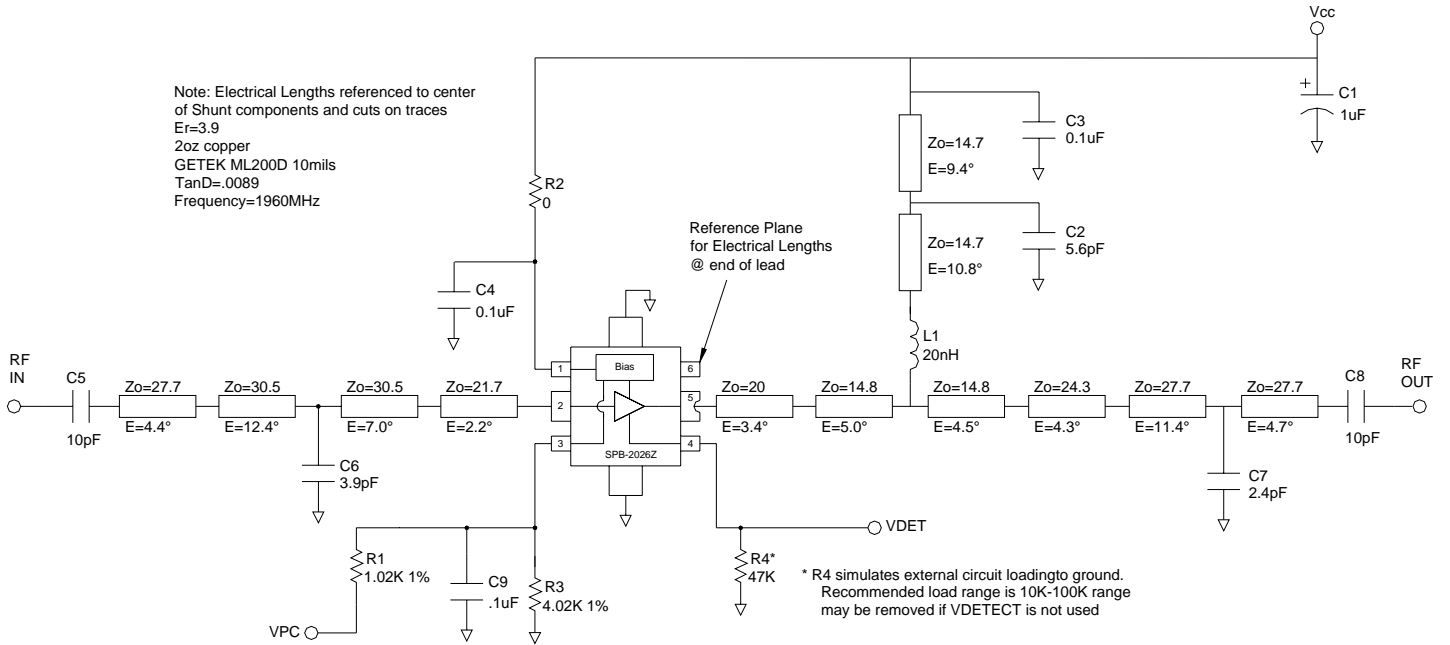

**1930 - 1990MHz Evaluation Board Layout (Vcc & Vpc = 5.0V)**

Board material GETEK, 10mil thick, Er=3.9, 2 oz. copper

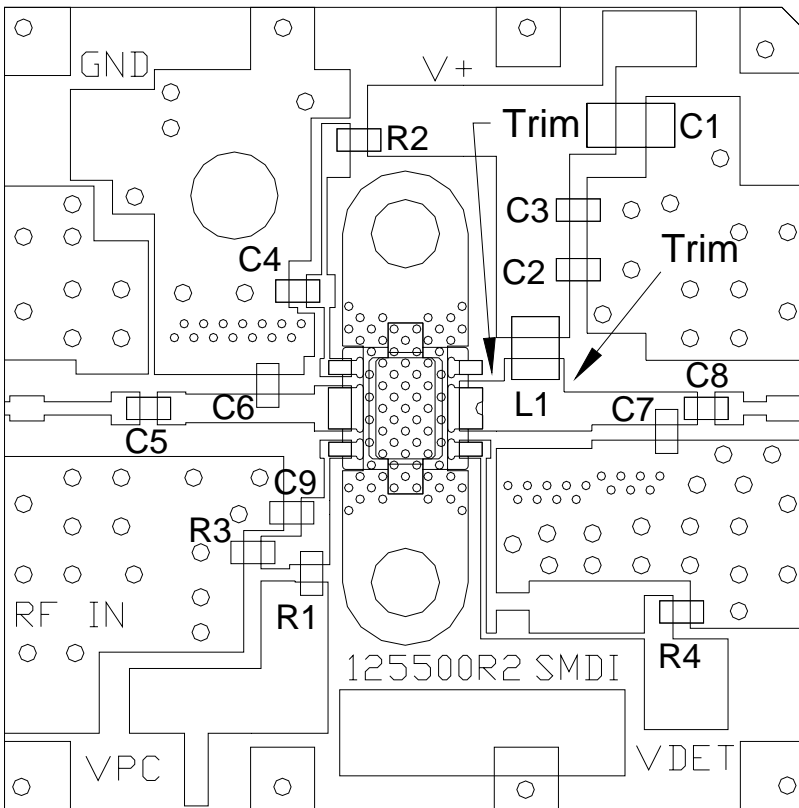

DESG	DESCRIPTION
Q1	SPB-2026Z
R1	1.02K OHM, 0603 1%
R2	0 OHM, 0603
R3	4.02K OHM, 0603 1%
R4	47K OHM, 0603
C1	1uF Tant.
C2	5.6pF CAP, 0603 AVX
C3,C4,C9	0.1uF CAP, 0603
C5	10pF CAP, 0603 AVX
C6	3.9pF CAP, 0603 AVX
C7	2.4pF CAP, 0603 AVX
C8	10pF CAP, 0603 AVX
L1	20nH IND, CC 0805HQ

**2110 - 2170MHz Application Circuit (Vcc & Vpc = 5.0V)**

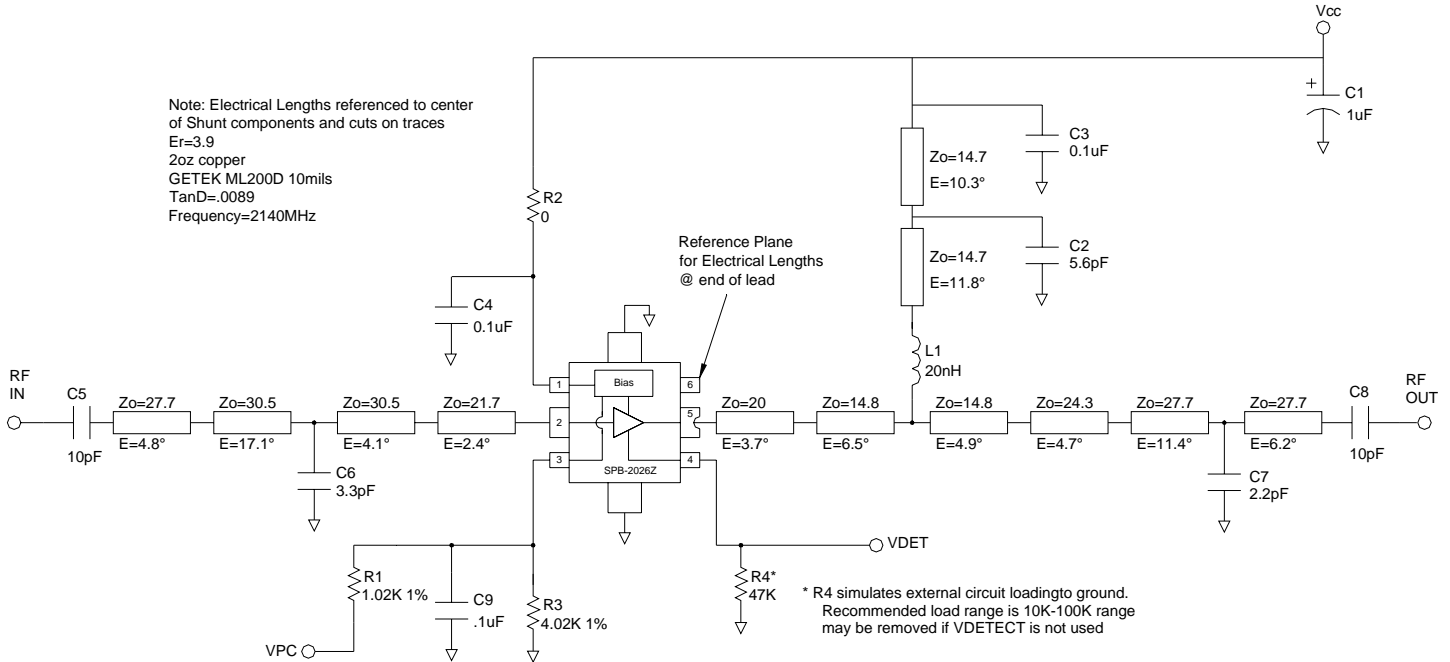

**2110 - 2170MHz Evaluation Board Layout (Vcc & Vpc = 5.0V)**

Board material GETEK, 10mil thick, Er=3.9, 2 oz. copper

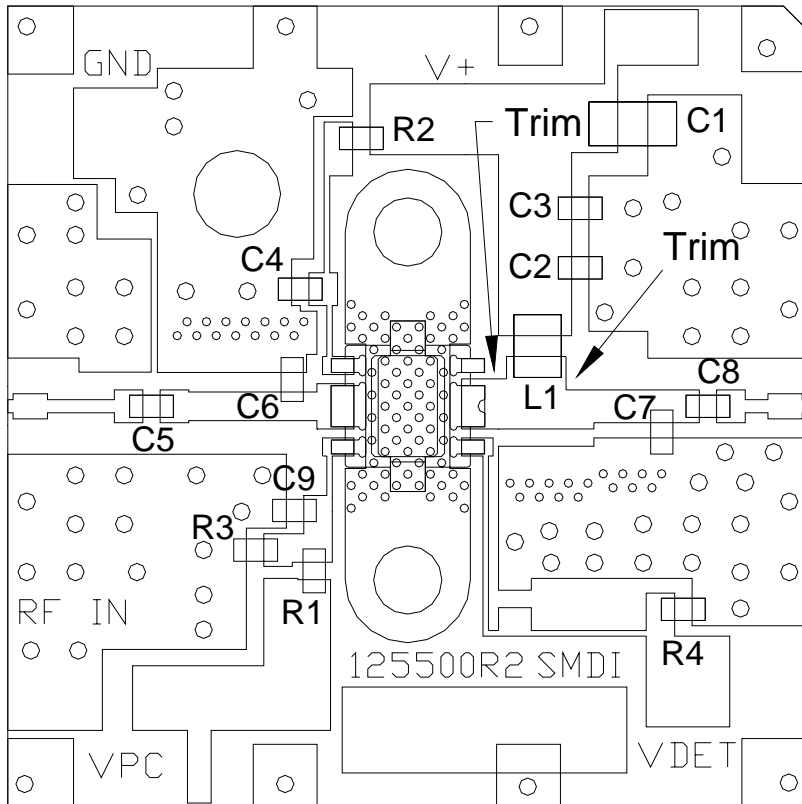

DESG	DESCRIPTION
Q1	SPB-2026Z
R1	1.02K OHM, 0603 1%
R2	0 OHM, 0603
R3	4.02K OHM, 0603 1%
R4	47K OHM, 0603
C1	1uF Tant.
C2	5.6pF CAP, 0603 AVX
C3,C4,C9	0.1uF CAP, 0603
C5	10pF CAP, 0603 AVX
C6	3.3pF CAP, 0603 AVX
C7	2.2pF CAP, 0603 AVX
C8	10pF CAP, 0603 AVX
L1	20nH IND, CC 0805HQ

**Suggested PCB Pad Layout**  
Dimensions in mm [inches]

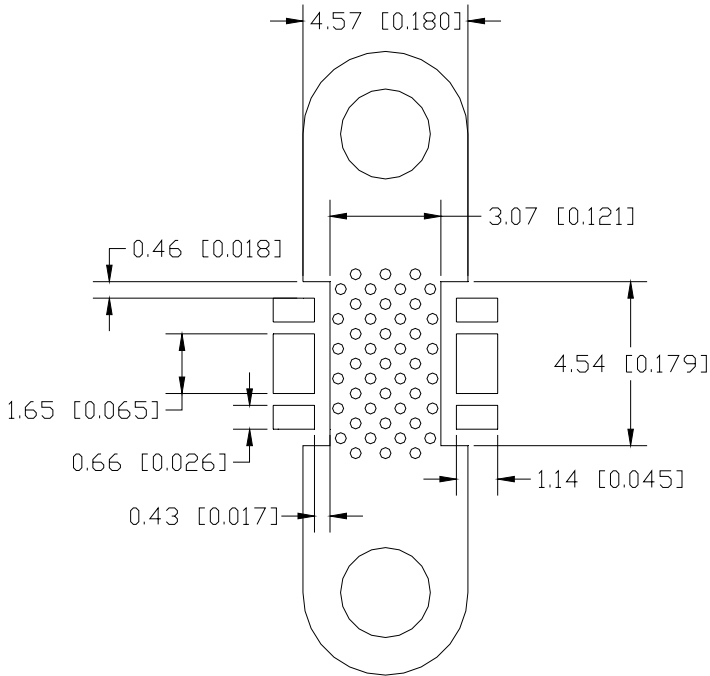

**Part Number Ordering Information**

Part Number	Reel Size	Devices / Reel
SPB-2026Z	13"	3000

**Nominal Package Dimensions**

Dimensions in millimeters (inches)  
Refer to package drawing posted at [www.sirenza.com](http://www.sirenza.com) for tolerances

