

## MICRO SWITCH™ BX/BX2 Series

### Hazardous Area Switches



#### DESCRIPTION

The MICRO SWITCH™ BX/BX2 Series is ideal for outdoor use or in adverse environments where a combination of explosion proof plus sealing requirements are needed. To comply with explosion-proof requirements the BX/BX2 has flame paths within the housing, which cool exploding gases below the ignition temperature before they reach explosive gases surrounding the housing. Flame paths on the BX/BX2 are (1) an extended plunger between the switch cavity and head and (2) the cover-housing threads on the front of the switch.

While the MICRO SWITCH™ BX Series features an aluminum housing, the MICRO SWITCH™ BX2 Series has a stainless steel housing that provides enhanced corrosion resistance in applications exposed to aggressive, caustic agents, as well as those often present in chemical processing plants, off-shore/near-shore sites, and other hazardous areas.

These products are weather sealed for outdoor use and designed for explosive gas/dust environments. The BX/BX2 Series is directly interchangeable with the LSX. Adapter plate not required. All heads are field adjustable at 90° increments.

Honeywell explosion-proof switches are designed specifically for use in hazardous location applications. The BX/BX2 enclosure is sealed for protection against corrosion, water, dust and oil as defined in IEC60529. The temperature

rating for these products depends upon the seal material used. Products using a fluorosilicone seal have a rating of -40 °C to 70 °C [-40 °F to 158 °F]. Products using a fluorocarbon seal have a rating of -12 °C [10 °F] to 70 °C [158 °F]. These enclosures meet Ex d IIC T6, Ta -40 °C to 70 °C and Ta -12 °C to 70 °C, respectively. As well as Ex d tD A21 IP67 T85 °C. SIRA 00ATEX1037X and IECEx SIR 07.0102X.

Compliance with the Essential Health and Safety Requirements has been assured by compliance with EN 60079-0:2006, EN 60079-1:2007, EN 61241-0:2004, EN 61241-0:2006, IEC 60079-0:2004 4<sup>th</sup> Ed., IEC 60079-0:2007 6<sup>th</sup> Ed., IEC 61241-0:2004 1<sup>st</sup> Ed., and IEC 61241-1:2004 1<sup>st</sup> Ed. The maximum construction gap (ic) is less than that required by Table 2 of EN/IEC60079-1:2007, clause 5.2.2 as detailed below.

Flame path	Max. gap	Comment
Push rod & bearing	0,076 mm	Cylindrical spigot joint

All BX2 conduit types and BX products with conduit types 1/2-14NPT, 3/4-14NPT also meet the North American Hazardous Locations Designation: NEMA 7 - Class I, Groups B, C and D; NEMA 9 - Class II, Groups E, F and G and comply with UL Standard: UL 894.

#### FEATURES





- BX (M20, PG13.5, or PF1/2 conduit): ATEX and IEC Ex
- BX (1/2-14 NPT, 3/4-14 NPT): UL, CSA, ATEX, IEC Ex
- BX2: UL, cUL, ATEX IEC Ex
- BX/BX2: IP67; NEMA 1, 3, 4, 6, 13
- BX (1/2-14 NPT, 3/4-14 NPT) and BX2: NEMA 7, 9 (Div. 1, Class I, Groups B, C, & D Div 1, Class II, Groups E, F, & G)
- BX/BX2: II 2 G; Ex d IIC T6 • II 2 D; Ex d tD A21 T85°C
- Choice of housing: aluminum or stainless steel
- Diverse conduit selection for wide range of applications
- Variety of heads and non-sparking actuators
- 10 A continuous carry electrical rating
- Choice of silver or gold contacts
- External and internal grounding screw
- Fluorocarbon and low-temperature sealing

#### POTENTIAL APPLICATIONS

- Control valves and actuators
- Offshore drilling
- Grain elevators
- Petrochemical plants
- Chemical plants
- Waste treatment
- Paint booths
- Mining conveyors
- Pulp and paper coating
- Hazardous waste handling





# MICRO SWITCH™ BX/BX2 Series

## SELECTION GUIDE

Features					
	<b>BX4A3K</b>	<b>BX24A3K</b>	<b>BX4A3K-1A</b>	<b>BX24A3K-1A</b>	<b>BX24P4L</b>
<b>Description</b>	Side rotary, momentary, no lever, 1NO/1NC		Side rotary, momentary, with lever, 1NO/1NC		Side rotary, momentary, low pre-travel, 2NO/2NC
<b>Actuator</b>	Lever not included - reference lever required accessory		1.5 in fixed length lever with front mounted nylon roller (.75 in dia. x .25 in wide)		Lever not included - reference lever required accessory
<b>Conduit Thread</b>	20 mm conduit		20 mm conduit		20 mm conduit
<b>Circuitry</b>	1NC 1NO single-pole double-throw, snap-action, double-break		1NC 1NO single-pole double-throw, snap-action, double-break		2NO 2 NC double-pole double-throw, snap-action, double-break
<b>Approvals</b>	ATEX, IEC Ex	UL, cUL, ATEX IEC Ex	ATEX, IEC Ex	UL, cUL, ATEX IEC Ex	UL, cUL, ATEX, IEC Ex
<b>Actuator</b>	Side rotary		Side rotary		Side rotary
<b>Pretravel</b>	15°		15°		9°
<b>Overtravel</b>	60°		60°		68°
<b>Differential Travel</b>	5°		5°		4°
<b>Operating Torque</b>	0,45 N m max. [4 in-lb max.]				
<b>UL File #</b>	-		-		-
<b>CSA File #</b>	-		-		-
<b>Sealing</b>	IP67; NEMA 1, 3, 4, 6, 13	IP67; NEMA 1, 3, 4, 6, 7, 9, 13	IP67; NEMA 1, 3, 4, 6, 13	IP67; NEMA 1, 3, 4, 6, 7, 9, 13	IP67; NEMA 1, 3, 4, 6, 7, 9, 13
<b>Product Type</b>	Weather-sealed, explosion-proof limit switches/IEC Ex approvals				
<b>Ampere Rating</b>	10 A (Thermal)				
<b>Supply Voltage</b>	600 Vac and 250 Vdc max.				
<b>Operating Temperature Range</b>	-40 °C to 70 °C [-40 °F to 158 °F]				
<b>Housing Material</b>	Aluminum (BX Series); Stainless Steel (BX2 Series)				
<b>Housing Type</b>	BX non plug-in				
<b>Sealed</b>	Explosion-proof				
<b>Availability</b>	Global				
<b>Agency Approvals and Standards</b>	<ul style="list-style-type: none"> <li>• BX (M20, PG13.5, or PF1/2 conduit): ATEX and IEC Ex</li> <li>• BX (1/2-14 NPT, 3/4-14 NPT): UL, CSA, ATEX, IEC Ex</li> <li>• BX2: UL, cUL, ATEX IEC Ex</li> <li>• BX/BX2: IP67; NEMA 1, 3, 4, 6, 13</li> <li>• BX (1/2-14 NPT, 3/4-14 NPT) and BX2: NEMA 7, 9 (Div. 1, Class I, Groups B, C, &amp; D Div 1, Class II, Groups E, F, &amp; G</li> <li>• BX/BX2: II 2 G; Ex d IIC T6 • II 2 D; Ex d tD A21 T85°C)</li> </ul>				







# Hazardous Area Switches

## SELECTION GUIDE

<b>Features</b>				
	<b>BX4D3K</b>	<b>BX4C3K</b>	<b>BX24C4L</b>	<b>BXA4L</b>
<b>Description</b>	Top roller plunger, 1NO/1NC	Top plunger plain, 1NC/1NC	Top plunger plain, 2NO/2NC	Side rotary, momentary, no lever, 2NO/2NC
<b>Actuator</b>	N/A	N/A		Lever not included - reference lever required accessory
<b>Conduit Thread</b>	20mm conduit	20 mm conduit		3/4 in - 14NPT conduit
<b>Circuitry</b>	1NC 1NO single-pole double-throw, snap-action, double-break	1NC 1NO single-pole double-throw, snap-action, double-break	2NO 2 NC double-pole double-throw, snap-action, double-break	2NC 2NO single-pole double-throw, snap-Action, double-break
<b>Approvals</b>	ATEX, IEC Ex	ATEX, IEC Ex	UL, cUL, ATEX IEC Ex	UL, CSA, ATEX, IEC Ex
<b>Actuator</b>	Top roller plunger	Top plunger		Side rotary
<b>Pretravel</b>	1,78 mm [0.070 in]	1,78 mm [0.070 in]		15°
<b>Overtravel</b>	4,83 mm [0.190 in]	4,83 mm [0.190 in]		60°
<b>Differential Travel</b>	0,38 mm [0.015 in]	0,38 mm [0.015 in]	0,51 mm [0.020 in]	7°
<b>Operating Position</b>	68.6 mm ± 1 mm [2.700 in ± 0.040 in]	58.5 mm ± 0.76 mm [2.305 in ± 0.030 in]		-
<b>Operating Torque</b>	-	-		0,45 N m max. [4 in-lb max.]
<b>Operating Force</b>	0,45 N max. [4 lb max.]	0,45 N max. [4 lb max.]		-
<b>UL File#</b>	-	-		E61730
<b>CSA File #</b>	-	-		LR57327
<b>Sealing</b>	IP67; NEMA 1, 3, 4, 6, 13	IP67; NEMA 1, 3, 4, 6, 13	IP67; NEMA 1, 3, 4, 6, 7, 9, 13	IP67; NEMA 1, 3, 4, 6, 7, 9, 13
<b>Product Type</b>	Weather-sealed, explosion-proof limit switches/IEC Ex approvals			
<b>Ampere Rating</b>	10 A (Thermal)			
<b>Supply Voltage</b>	600 Vac and 250 Vdc max.			
<b>Operating Temperature Range</b>	-40 °C to 70 °C [ -40 °F to 158 °F]			
<b>Housing Material</b>	Aluminum (BX Series); Stainless Steel (BX2 Series)			
<b>Housing Type</b>	BX non-plug-in			
<b>Sealed</b>	Explosion-proof			
<b>Availability</b>	Global			
<b>Agency Approvals and Standards</b>	<ul style="list-style-type: none"> <li>• BX (M20, PG13.5, or PF1/2 conduit): ATEX and IEC Ex</li> <li>• BX (1/2-14 NPT, 3/4-14 NPT): UL, CSA, ATEX, IEC Ex</li> <li>• BX2: UL, cUL, ATEX IEC Ex</li> <li>• BX/BX2: IP67; NEMA 1, 3, 4, 6, 13</li> <li>• BX (1/2-14 NPT, 3/4-14 NPT) and BX2: NEMA 7, 9 (Div. 1, Class I, Groups B, C, &amp; D Div 1, Class II, Groups E, F, &amp; G)</li> <li>• BX/BX2: II 2 G; Ex d IIC T6 • II 2 D; Ex d tD A21 T85°C</li> </ul>			

# MICRO SWITCH™ BX/BX2 Series

## SELECTION GUIDE

						
<b>Features</b>	<b>BXP4L</b>	<b>BX2P4L</b>	<b>BXA3K</b>	<b>BX2A3K</b>	<b>BXC4L</b>	<b>BX2C4L</b>
<b>Description</b>	Side rotary, momentary, low pre-travel, 2NO/2NC		Side rotary, momentary, no lever, 1NO/1NC		Top plunger plain, 2NO/2NC	
<b>Actuator</b>	Lever not included - reference lever required accessory		Lever not included - reference lever required accessory		N/A	
<b>Conduit Thread</b>	3/4 in - 14NPT conduit		1/2 in - 14NPT conduit		3/4 in - 14NPT conduit	
<b>Circuitry</b>	2NO 2 NC double-pole double-throw, snap-action, double-break		1NC 1NO single-pole double-throw, snap-action, double-break		2NO 2 NC double-pole double-throw, snap-action, double-break	
<b>Approvals</b>	UL, CSA, ATEX, IEC Ex	UL, cUL, ATEX IEC Ex	UL, CSA, ATEX, IEC Ex	UL, cUL, ATEX IEC Ex	UL, CSA, ATEX, IEC Ex	UL, cUL, ATEX IEC Ex
<b>Actuator</b>	Side rotary		Side rotary		Top plunger	
<b>Pretravel</b>	9°		15°		1,78 mm [0.070 in]	
<b>Overtravel</b>	68°		60°		4,83 mm [0.190 in]	
<b>Differential Travel (D.T.)</b>	4°		5°		0,51 mm [0.020 in]	
<b>Operating Position</b>	-		-		58.5 mm ± 0.76 mm [2.305 in ± 0.030 in]	
<b>Operating Force</b>	-		-		0,45 N max. [4 lb max.]	
<b>Operating Torque</b>	0,45 N m max. [4 in-lb max.]					
<b>UL File #</b>	-		E61730	-	-	
<b>CSA File #</b>	-		LR57327	-	-	
<b>Sealing</b>	IP67; NEMA 1, 3, 4, 6, 7, 9, 13		IP67; NEMA 1, 3, 4, 6, 7, 9, 13		IP67; NEMA 1, 3, 4, 6, 7, 9, 13	
<b>Product Type</b>	Weather-sealed, explosion-proof limit switches/IEC Ex approvals					
<b>Ampere Rating</b>	10 A (Thermal)					
<b>Supply Voltage</b>	600 Vac and 250 Vdc max.					
<b>Operating Temperature Range</b>	-40 °C to 70 °C [-40 °F to 158 °F]					
<b>Housing Material</b>	Aluminum (BX Series); Stainless Steel (BX2 Series)					
<b>Housing Type</b>	BX non plug-in					
<b>Sealed</b>	Explosion-proof					
<b>Operating Force (O.F.)</b>	0,45 N max. [4 in lb max.]					
<b>Availability</b>	Global					
<b>Agency Approvals and Standards</b>	<ul style="list-style-type: none"> <li>• BX (M20, PG13.5, or PF1/2 conduit): ATEX and IEC Ex</li> <li>• BX (1/2-14 NPT, 3/4-14 NPT): UL, CSA, ATEX, IEC Ex</li> <li>• BX2: UL, cUL, ATEX IEC Ex</li> <li>• BX/BX2: IP67; NEMA 1, 3, 4, 6, 13</li> <li>• BX (1/2-14 NPT, 3/4-14 NPT) and BX2: NEMA 7, 9 (Div. 1, Class I, Groups B, C, &amp; D Div 1, Class II, Groups E, F, &amp; G)</li> <li>• BX/BX2: II 2 G; Ex d IIC T6 • II 2 D; Ex d tD A21 T85°C</li> </ul>					





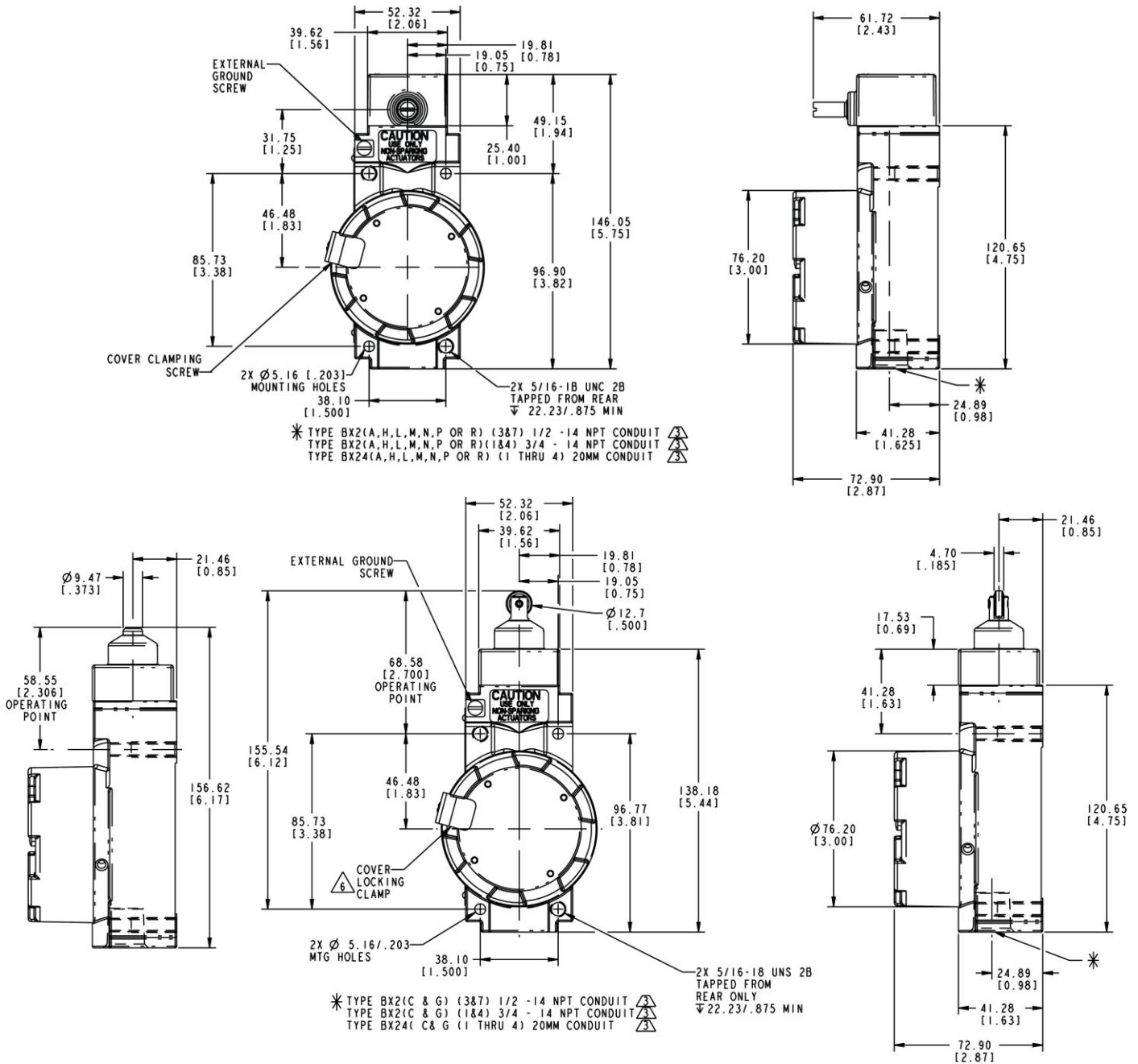

# MICRO SWITCH™ BX/BX2 Series





**BX2 MOUNTING DIMENSIONS** (For reference only) mm/in



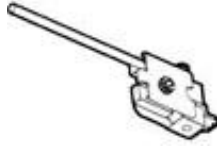

Conduit sizes 1/2-14NPT, 3/4-14NPT, M20, PG13.5, PF1/2 are available for each switch type and carry ATEX and IEC Ex approvals. 1/2-14 NPT, 3/4-14 NPT, and M20 carry UL and CSA approvals  
Verify that the mating threaded fitting is identical with the conduit thread shown on the product nameplate

# Hazardous Area Switches

<b>BX Levers – Required Accessories</b>					
<b>Lever style</b>	Roller – standard	Roller – standard	Roller – adjustable	Roller – adjustable	Roller – adjustable
<b>Comment</b>	Roller - standard; material: nylon; roller mounted on front of lever	Roller - standard; material: nylon; roller mounted on back of lever	Roller - adjustable; material: nylon; roller mounted on front of lever	Roller - adjustable; material: nylon; roller mounted on front of lever	Roller - adjustable; material: nylon; roller mounted on front of lever
<b>Radius</b>	38,1 mm [1.5 in]	38,1 mm [1.5 in]	38,1 mm to 88,9 mm [1.5 in to 3.5 in]	38,1 mm to 88,9 mm [1.5 in to 3.5 in]	38,1 mm to 88,9 mm [1.5 in to 3.5 in]
<b>Diameter</b>	19,05 mm [0.75 in]	19,05 mm [0.75 in]	19,05 mm [0.75 in]	25,4 mm [1.0 in]	38,1 mm [1.5 in]
<b>Width</b>	6,35 mm [0.25 in]	6,35 mm [0.25 in]	6,35 mm [0.25 in]	12,7 mm [0.5 in]	6,35 mm [0.25 in]
<b>Product type</b>	Lever				
<b>Availability</b>	Global				

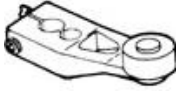
<b>BX Levers – Required Accessories</b>					
<b>Lever style</b>	Roller – yoke	Roller – yoke	Rod – standard	Roller with offset	Roller with offset
<b>Comment</b>	Roller - yoke; material: nylon; roller mounted on back-front of lever	Roller - yoke; material: nylon; roller mounted on back-back of lever	Rod - standard; material: aluminum; material: aluminum	Roller - with offset; material: nylon; roller mounted on back of lever	Roller - with offset; material: nylon; roller mounted on front of lever
<b>Radius</b>	38,1 mm [1.5 in]	38,1 mm [1.5 in]	139,7 mm [5.5 in]	38,1 mm [1.5 in]	38,1 mm [1.5 in]
<b>Diameter</b>	19,05 mm [0.75 in]	19,05 mm [0.75 in]	-	19,05 mm [0.75 in]	19,05 mm [0.75 in]
<b>Width</b>	6,35 mm [0.25 in]	6,35 mm [0.25 in]	-	6,35 mm [0.25 in]	6,35 mm [0.25 in]
<b>Product type</b>	Lever				
<b>Availability</b>	Global				

<b>BX2 Levers – Required Accessories</b>			
<b>Lever style</b>	Non-sparking roller – standard	Non-sparking roller – standard	Non-sparking roller – adjustable
<b>Comment</b>	Roller - standard; material: nylon; roller mounted on front of lever	Roller - standard; material: nylon; roller mounted on back of lever	Roller - adjustable; material: nylon; roller mounted on front of lever
<b>Radius</b>	38,1 mm [1.5 in]	38,1 mm [1.5 in]	38,1 mm to 88,9 mm [1.5 in to 3.5 in]
<b>Diameter</b>	19,05 mm [0.75 in]	40,38 mm [1.59 in]	19,05 mm [0.75 in]
<b>Width</b>	12,7 mm [0.5 in]	6,35 mm [0.25 in]	6,35 mm [0.25 in]
<b>Product type</b>	Lever		
<b>Availability</b>	Global		



## **WARNING**

### **IF USED IN APPLICATIONS CONCERNING HUMAN SAFETY**

- Use only NC direct opening (“positive opening”/“positive break”) contacts, identified by the symbol.
- Do NOT use flexible/adjustable actuators. Only use actuators designed for safety applications.
- Do NOT defeat, tamper, remove, or bypass this switch.
- Hazardous voltage, disconnect power before servicing
- Strictly adhere to all installation and maintenance instructions
- Consult with local safety agencies and their requirements when designing a machine-control link, interface and all control elements that affect safety.

**Failure to comply with these instructions could result in death or serious injury.**

## **WARNING**

### **OPENING PRODUCTS HAZARD**

**DO NOT OPEN** these products when energized or in a flammable gas atmosphere.

**Failure to comply with these instructions could result in death or serious injury.**

### **WARRANTY/REMEDY**

Honeywell warrants goods of its manufacture as being free of defective materials and faulty workmanship. Honeywell's standard product warranty applies unless agreed to otherwise by Honeywell in writing; please refer to your order acknowledgement or consult your local sales office for specific warranty details. If warranted goods are returned to Honeywell during the period of coverage, Honeywell will repair or replace, at its option, without charge those items it finds defective. **The foregoing is buyer's sole remedy and is in lieu of all other warranties, expressed or implied, including those of merchantability and fitness for a particular purpose. In no event shall Honeywell be liable for consequential, special, or indirect damages.**

While we provide application assistance personally, through our literature and the Honeywell web site, it is up to the customer to determine the suitability of the product in the application.

Specifications may change without notice. The information we supply is believed to be accurate and reliable as of this printing. However, we assume no responsibility for its use.

## **WARNING**

### **IMPROPER CONDUIT THREAD USE**

**DO NOT USE** any other conduit thread than the one identified on the product. Verify that the mating threaded fitting is identical with the conduit thread shown on the product nameplate.

**Failure to comply with these instructions could result in death or serious injury.**

## **WARNING**

### **MISUSE OF DOCUMENTATION**

- The information presented in this product sheet is for reference only. Do not use this document as a product installation guide.
- Complete installation, operation, and maintenance information is provided in the instructions supplied with each product.

**Failure to comply with these instructions could result in death or serious injury.**

### **SALES AND SERVICE**

Honeywell serves its customers through a worldwide network of sales offices, representatives and distributors. For application assistance, current specifications, pricing or name of the nearest Authorized Distributor, contact your local sales office or:

**E-mail:** [info.sc@honeywell.com](mailto:info.sc@honeywell.com)

**Internet:** [www.honeywell.com/sensing](http://www.honeywell.com/sensing)

#### **Phone and Fax:**

Asia Pacific	+65 6355-2828
	+65 6445-3033 Fax
Europe	+44 (0) 1698 481481
	+44 (0) 1698 481676 Fax
Latin America	+1-305-805-8188
	+1-305-883-8257 Fax
USA/Canada	+1-800-537-6945
	+1-815-235-6847
	+1-815-235-6545 Fax

Sensing and Control  
Honeywell  
1985 Douglas Drive North  
Golden Valley, MN 55422  
[www.honeywell.com/sensing](http://www.honeywell.com/sensing)

002306-4-EN IL50 GLO Printed in USA  
May 2010  
Copyright © 2010 Honeywell International Inc. All rights reserved.

# Honeywell