

IEC Appliance Inlet C14 with Filter, Line Switch 1- or 2-pole, Front or Rear Side Mounting

Standard- or Medical-Filter



new

Screw-On Version  
from front side

from front side

Screw-On Version  
from rear side

C14

70° C

**Description**

- Panel Mount:  
Screw-on version from front or rear side, snap-in version from front side
- 3 Functions:  
Appliance Inlet Protection class I, Line Switch 1- or 2-pole, Line filter in standard and medical version
- Quick connect terminals 6.3 x 0.8 mm
- Alternative: version without line filter [DC11](#)
- Substitute for type [KFB1](#); [KFB2](#)

**Approvals**

- VDE License Number: 40001522
- UL License Number: E72928

**Characteristics**

- Compact design with optimal shielding
- Rear side mounting for efficient cost-saving assembly
- All single elements are already wired
- Line switch non-illuminated or illuminated
- Marquard switch for high inrush currents
- Universal line filter for standard applications
- Ideal for application with high transient loads
- Qualified for use in equipment according IEC/EN 60950

**Other versions on request**

- Solder terminals
- Other rocker marking
- Capacitance CX1

**References**

[General Product Information](#)

**Weblinks**

[Approvals](#), [RoHS](#), [CHINA-RoHS](#), [Mating Connectors](#), [e-Store](#), [Distributor-Stock-Check](#), [Accessories](#)

**Technical Data**

Ratings IEC	1 - 10A @ T <sub>a</sub> 40 °C / 250VAC; 50Hz
Ratings UL/CSA	1 - 10A @ T <sub>a</sub> 40 °C / 125VAC; 60Hz
Leakage Current	standard < 0.5mA (250V / 60Hz) medical < 5 µA (250V / 60Hz)
Dielectric Strength	> 1.7kVDC between L-N > 2.7kVDC between L/N-PE Test voltage (2 sec)
Allowable Operation Temp.	-25°C to 85°C
Climatic Category	25/085/21 acc. to IEC 60068-1
Degree of Protection	from front side IP 40 acc. to IEC 60529
Protection Class	Suitable for appliances with protection class 1 acc. to IEC 61140
Terminal	Quick connect terminals 6.3 x 0.8 mm
Panel Thickness s	Screw: max 8 mm Mounting screw torque max 0.5Nm Snap-in: 1 mm to 3 mm
Material: Housing	Thermoplastic, black, UL 94V-0

Appliance-Inlet/-Outlet	C14 acc. to IEC/EN 60320-1, UL 498, CSA C22.2 no. 42 (for cold conditions) pin-temperature 70 °C, 10A, Protection Class 1
Line Switch	Rocker switch 1 or 2 pole, non-illuminated or illuminated, acc. to IEC 61058-1 <a href="#">Technical details</a>
Line Filter	Standard and Medical Version, IEC 60939, IEC 60601-1, UL 1283, UL 544, EN 133 200, CSA C22.2 no. 8 <a href="#">Technical details</a>
MTBF	> 1'900'000h acc. to MIL-HB-217 F

### Dimensions

Screw-on mounting from front side

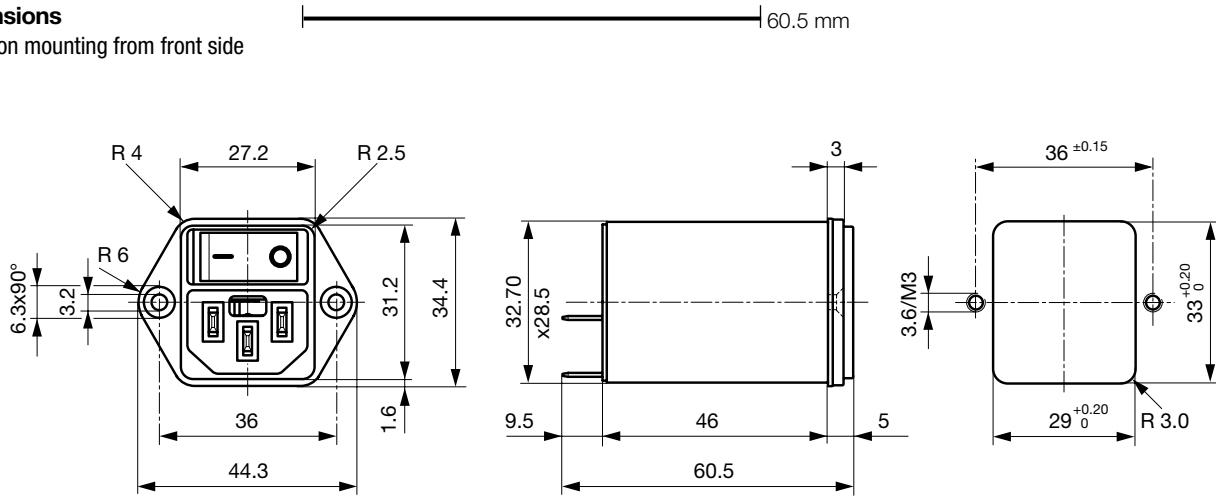

Screw-On Version from rear side (metal flange)

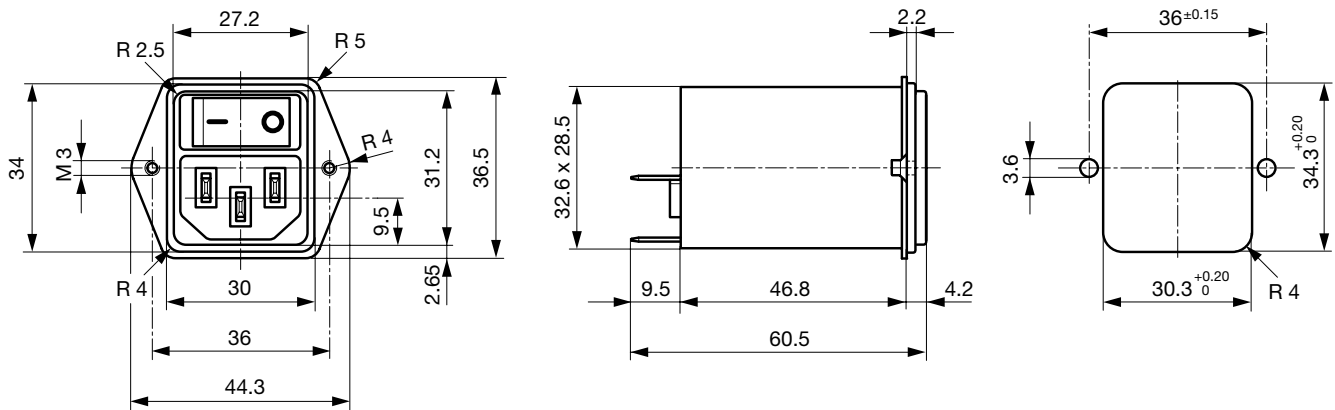

Snap-in mounting from front side

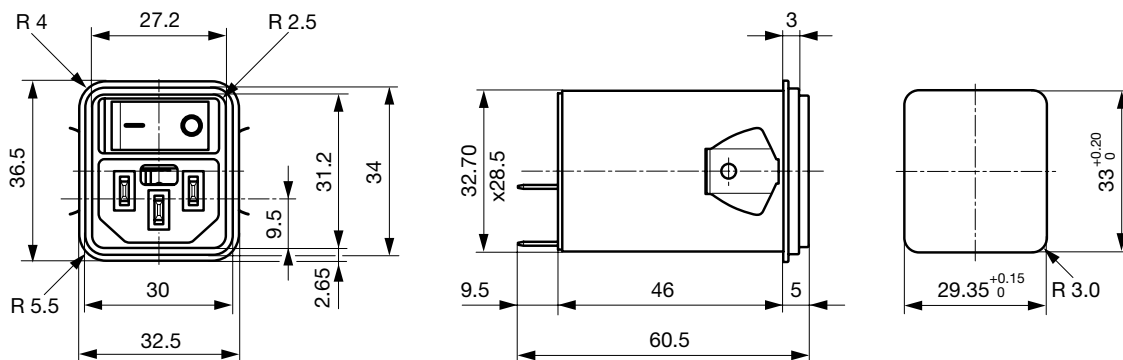

Technical Data of Filter-Components

Rated Current [A]	Filter-Type	Inductances L [mH]	Capacitance CX [nF]	Capacitance CY [nF]	R [MΩ]
1	Standard Version	2 x 10	100	2.2	1
2	Standard Version	2 x 4	100	2.2	1
4	Standard Version	2 x 1.5	100	2.2	1
6	Standard Version	2 x 0.8	100	2.2	1
10	Standard Version	2 x 0.3	100	2.2	1
1	Medical Version (M5)	2 x 10	100	-	1
2	Medical Version (M5)	2 x 4	100	-	1
4	Medical Version (M5)	2 x 1.5	100	-	1
6	Medical Version (M5)	2 x 0.8	100	-	1
10	Medical Version (M5)	2 x 0.3	100	-	1
1	Medical Version (M80)	2 x 10	100	0.47	1
2	Medical Version (M80)	2 x 4	100	0.47	1
4	Medical Version (M80)	2 x 1.5	100	0.47	1
6	Medical Version (M80)	2 x 0.8	100	0.47	1
10	Medical Version (M80)	2 x 0.3	100	0.47	1

Diagrams

Standard filter 1-pole

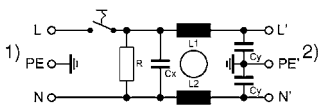

- 1) Line
- 2) Load

Standard filter 2-pole

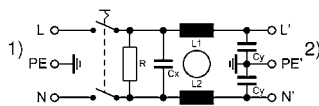

- 1) Line
- 2) Load

Medical filter 1-pole (M5)

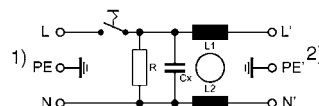

- 1) Line
- 2) Load

Medical filter 2-pole (M5)

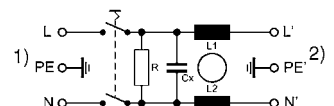

- 1) Line
- 2) Load

Standard filter 2-pole illuminated

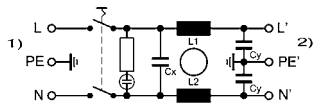

- 1) Line
- 2) Load

Medical Filter 2-pole (M5) illuminated

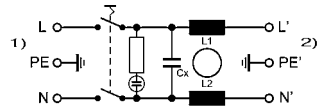

- 1) Line
- 2) Load

Attenuation Loss

--- differential mode \_\_\_\_ common mode

Standard version

1 A

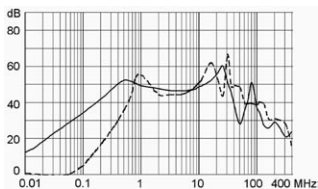

2 A

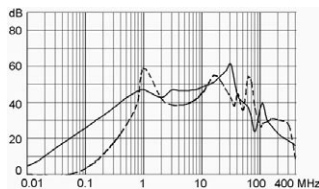

4 A

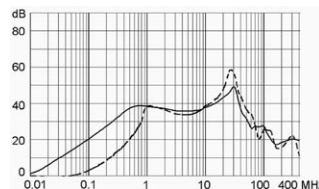

6 A

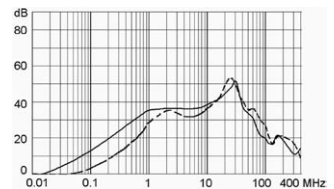

10 A

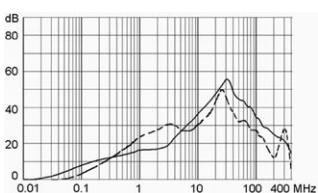

Medical version (M5)

1 A

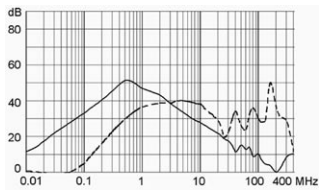

2 A

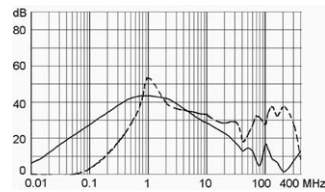

4 A

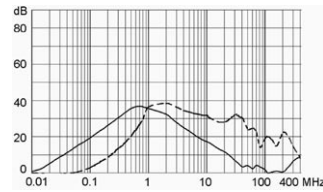

6 A

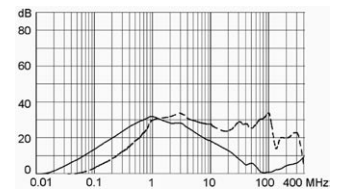

10 A

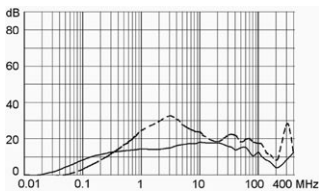

### Variants

Rated Current [A]	Filter-Type	Panel mounting	Mounting side	Line Switch	Illumination	Color	Order Number
1	Standard Version	Screw	Front-Side	1-pole	non-illuminated	-	DC12.1102.003
2	Standard Version	Screw	Front-Side	1-pole	non-illuminated	-	DC12.2102.003
4	Standard Version	Screw	Front-Side	1-pole	non-illuminated	-	DC12.3102.003
6	Standard Version	Screw	Front-Side	1-pole	non-illuminated	-	DC12.4102.003
10	Standard Version	Screw	Front-Side	1-pole	non-illuminated	-	DC12.5102.003
1	Standard Version	Screw	Front-Side	1-pole	illuminated	red	DC12.1122.003
1	Standard Version	Screw	Front-Side	1-pole	illuminated	green	DC12.1132.003
2	Standard Version	Screw	Front-Side	1-pole	illuminated	red	DC12.2122.003
2	Standard Version	Screw	Front-Side	1-pole	illuminated	green	DC12.2132.003
4	Standard Version	Screw	Front-Side	1-pole	illuminated	red	DC12.3122.003
4	Standard Version	Screw	Front-Side	1-pole	illuminated	green	DC12.3132.003
6	Standard Version	Screw	Front-Side	1-pole	illuminated	red	DC12.4122.003
6	Standard Version	Screw	Front-Side	1-pole	illuminated	green	DC12.4132.003
10	Standard Version	Screw	Front-Side	1-pole	illuminated	red	DC12.5122.003
10	Standard Version	Screw	Front-Side	1-pole	illuminated	green	DC12.5132.003
1	Standard Version	Screw	Front-Side	2-pole	non-illuminated	-	DC12.1102.001
2	Standard Version	Screw	Front-Side	2-pole	non-illuminated	-	DC12.2102.001
4	Standard Version	Screw	Front-Side	2-pole	non-illuminated	-	DC12.3102.001
6	Standard Version	Screw	Front-Side	2-pole	non-illuminated	-	DC12.4102.001
10	Standard Version	Screw	Front-Side	2-pole	non-illuminated	-	DC12.5102.001
1	Standard Version	Screw	Front-Side	2-pole	illuminated	red	DC12.1122.001
1	Standard Version	Screw	Front-Side	2-pole	illuminated	green	DC12.1132.001
2	Standard Version	Screw	Front-Side	2-pole	illuminated	red	DC12.2122.001
2	Standard Version	Screw	Front-Side	2-pole	illuminated	green	DC12.2132.001
4	Standard Version	Screw	Front-Side	2-pole	illuminated	red	DC12.3122.001
4	Standard Version	Screw	Front-Side	2-pole	illuminated	green	DC12.3132.001
6	Standard Version	Screw	Front-Side	2-pole	illuminated	red	DC12.4122.001
6	Standard Version	Screw	Front-Side	2-pole	illuminated	green	DC12.4132.001
10	Standard Version	Screw	Front-Side	2-pole	illuminated	red	DC12.5122.001
10	Standard Version	Screw	Front-Side	2-pole	illuminated	green	DC12.5132.001
1	Standard Version	Screw	Rear-Side	1-pole	non-illuminated	-	DC12.1102.203
2	Standard Version	Screw	Rear-Side	1-pole	non-illuminated	-	DC12.2102.203
4	Standard Version	Screw	Rear-Side	1-pole	non-illuminated	-	DC12.3102.203
6	Standard Version	Screw	Rear-Side	1-pole	non-illuminated	-	DC12.4102.203
10	Standard Version	Screw	Rear-Side	1-pole	non-illuminated	-	DC12.5102.203
1	Standard Version	Screw	Rear-Side	2-pole	non-illuminated	-	DC12.1102.201
2	Standard Version	Screw	Rear-Side	2-pole	non-illuminated	-	DC12.2102.201

Rated Current [A]	Filter-Type	Panel mounting	Mounting side	Line Switch	Illumination	Color	Order Number
4	Standard Version	Screw	Rear-Side	2-pole	non-illuminated	-	DC12.3102.201
6	Standard Version	Screw	Rear-Side	2-pole	non-illuminated	-	DC12.4102.201
10	Standard Version	Screw	Rear-Side	2-pole	non-illuminated	-	DC12.5102.201
1	Standard Version	Snap-in	Front-Side	1-pole	non-illuminated	-	DC12.1102.103
2	Standard Version	Snap-in	Front-Side	1-pole	non-illuminated	-	DC12.2102.103
4	Standard Version	Snap-in	Front-Side	1-pole	non-illuminated	-	DC12.3102.103
6	Standard Version	Snap-in	Front-Side	1-pole	non-illuminated	-	DC12.4102.103
10	Standard Version	Snap-in	Front-Side	1-pole	non-illuminated	-	DC12.5102.103
1	Standard Version	Snap-in	Front-Side	1-pole	illuminated	red	DC12.1122.103
1	Standard Version	Snap-in	Front-Side	1-pole	illuminated	green	DC12.1132.103
2	Standard Version	Snap-in	Front-Side	1-pole	illuminated	red	DC12.2122.103
2	Standard Version	Snap-in	Front-Side	1-pole	illuminated	green	DC12.2132.103
4	Standard Version	Snap-in	Front-Side	1-pole	illuminated	red	DC12.3122.103
4	Standard Version	Snap-in	Front-Side	1-pole	illuminated	green	DC12.3132.103
6	Standard Version	Snap-in	Front-Side	1-pole	illuminated	red	DC12.4122.103
6	Standard Version	Snap-in	Front-Side	1-pole	illuminated	green	DC12.4132.103
10	Standard Version	Snap-in	Front-Side	1-pole	illuminated	red	DC12.5122.103
10	Standard Version	Snap-in	Front-Side	1-pole	illuminated	green	DC12.5132.103
1	Standard Version	Snap-in	Front-Side	2-pole	non-illuminated	-	DC12.1102.101
2	Standard Version	Snap-in	Front-Side	2-pole	non-illuminated	-	DC12.2102.101
4	Standard Version	Snap-in	Front-Side	2-pole	non-illuminated	-	DC12.3102.101
6	Standard Version	Snap-in	Front-Side	2-pole	non-illuminated	-	DC12.4102.101
10	Standard Version	Snap-in	Front-Side	2-pole	non-illuminated	-	DC12.5102.101
1	Standard Version	Snap-in	Front-Side	2-pole	illuminated	red	DC12.1122.101
1	Standard Version	Snap-in	Front-Side	2-pole	illuminated	green	DC12.1132.101
2	Standard Version	Snap-in	Front-Side	2-pole	illuminated	red	DC12.2122.101
2	Standard Version	Snap-in	Front-Side	2-pole	illuminated	green	DC12.2132.101
4	Standard Version	Snap-in	Front-Side	2-pole	illuminated	red	DC12.3122.101
4	Standard Version	Snap-in	Front-Side	2-pole	illuminated	green	DC12.3132.101
6	Standard Version	Snap-in	Front-Side	2-pole	illuminated	red	DC12.4122.101
6	Standard Version	Snap-in	Front-Side	2-pole	illuminated	green	DC12.4132.101
10	Standard Version	Snap-in	Front-Side	2-pole	illuminated	red	DC12.5122.101
10	Standard Version	Snap-in	Front-Side	2-pole	illuminated	green	DC12.5132.101
1	Medical Version (M5)	Screw	Front-Side	1-pole	non-illuminated	-	DC12.1202.003
2	Medical Version (M5)	Screw	Front-Side	1-pole	non-illuminated	-	DC12.2202.003
4	Medical Version (M5)	Screw	Front-Side	1-pole	non-illuminated	-	DC12.3202.003
6	Medical Version (M5)	Screw	Front-Side	1-pole	non-illuminated	-	DC12.4202.003
10	Medical Version (M5)	Screw	Front-Side	1-pole	non-illuminated	-	DC12.5202.003
1	Medical Version (M5)	Screw	Front-Side	1-pole	illuminated	red	DC12.1222.003
1	Medical Version (M5)	Screw	Front-Side	1-pole	illuminated	green	DC12.1232.003
2	Medical Version (M5)	Screw	Front-Side	1-pole	illuminated	red	DC12.2222.003
2	Medical Version (M5)	Screw	Front-Side	1-pole	illuminated	green	DC12.2232.003
4	Medical Version (M5)	Screw	Front-Side	1-pole	illuminated	red	DC12.3222.003
4	Medical Version (M5)	Screw	Front-Side	1-pole	illuminated	green	DC12.3232.003
6	Medical Version (M5)	Screw	Front-Side	1-pole	illuminated	red	DC12.4222.003
6	Medical Version (M5)	Screw	Front-Side	1-pole	illuminated	green	DC12.4232.003
10	Medical Version (M5)	Screw	Front-Side	1-pole	illuminated	red	DC12.5222.003
10	Medical Version (M5)	Screw	Front-Side	1-pole	illuminated	green	DC12.5232.003
1	Medical Version (M5)	Screw	Front-Side	2-pole	non-illuminated	-	DC12.1202.001
2	Medical Version (M5)	Screw	Front-Side	2-pole	non-illuminated	-	DC12.2202.001
4	Medical Version (M5)	Screw	Front-Side	2-pole	non-illuminated	-	DC12.3202.001
6	Medical Version (M5)	Screw	Front-Side	2-pole	non-illuminated	-	DC12.4202.001
10	Medical Version (M5)	Screw	Front-Side	2-pole	non-illuminated	-	DC12.5202.001
1	Medical Version (M5)	Screw	Front-Side	2-pole	illuminated	red	DC12.1222.001
1	Medical Version (M5)	Screw	Front-Side	2-pole	illuminated	green	DC12.1232.001

Rated Current [A]	Filter-Type	Panel mounting	Mounting side	Line Switch	Illumination	Color	Order Number
2	Medical Version (M5)	Screw	Front-Side	2-pole	illuminated	red	DC12.2222.001
2	Medical Version (M5)	Screw	Front-Side	2-pole	illuminated	green	DC12.2232.001
4	Medical Version (M5)	Screw	Front-Side	2-pole	illuminated	red	DC12.3222.001
4	Medical Version (M5)	Screw	Front-Side	2-pole	illuminated	green	DC12.3232.001
6	Medical Version (M5)	Screw	Front-Side	2-pole	illuminated	red	DC12.4222.001
6	Medical Version (M5)	Screw	Front-Side	2-pole	illuminated	green	DC12.4232.001
10	Medical Version (M5)	Screw	Front-Side	2-pole	illuminated	red	DC12.5222.001
10	Medical Version (M5)	Screw	Front-Side	2-pole	illuminated	green	DC12.5232.001
1	Medical Version (M5)	Screw	Rear-Side	2-pole	non-illuminated	-	DC12.1202.201
2	Medical Version (M5)	Screw	Rear-Side	2-pole	non-illuminated	-	DC12.2202.201
4	Medical Version (M5)	Screw	Rear-Side	2-pole	non-illuminated	-	DC12.3202.201
6	Medical Version (M5)	Screw	Rear-Side	2-pole	non-illuminated	-	DC12.4202.201
10	Medical Version (M5)	Screw	Rear-Side	2-pole	non-illuminated	-	DC12.5202.201
1	Medical Version (M5)	Snap-in	Front-Side	1-pole	non-illuminated	-	DC12.1202.103
2	Medical Version (M5)	Snap-in	Front-Side	1-pole	non-illuminated	-	DC12.2202.103
4	Medical Version (M5)	Snap-in	Front-Side	1-pole	non-illuminated	-	DC12.3202.103
6	Medical Version (M5)	Snap-in	Front-Side	1-pole	non-illuminated	-	DC12.4202.103
10	Medical Version (M5)	Snap-in	Front-Side	1-pole	non-illuminated	-	DC12.5202.103
1	Medical Version (M5)	Snap-in	Front-Side	1-pole	illuminated	red	DC12.1222.103
1	Medical Version (M5)	Snap-in	Front-Side	1-pole	illuminated	green	DC12.1232.103
2	Medical Version (M5)	Snap-in	Front-Side	1-pole	illuminated	red	DC12.2222.103
2	Medical Version (M5)	Snap-in	Front-Side	1-pole	illuminated	green	DC12.2232.103
4	Medical Version (M5)	Snap-in	Front-Side	1-pole	illuminated	red	DC12.3222.103
4	Medical Version (M5)	Snap-in	Front-Side	1-pole	illuminated	green	DC12.3232.103
6	Medical Version (M5)	Snap-in	Front-Side	1-pole	illuminated	red	DC12.4222.103
6	Medical Version (M5)	Snap-in	Front-Side	1-pole	illuminated	green	DC12.4232.103
10	Medical Version (M5)	Snap-in	Front-Side	1-pole	illuminated	red	DC12.5222.103
10	Medical Version (M5)	Snap-in	Front-Side	1-pole	illuminated	green	DC12.5232.103
1	Medical Version (M5)	Snap-in	Front-Side	2-pole	non-illuminated	-	DC12.1202.101
2	Medical Version (M5)	Snap-in	Front-Side	2-pole	non-illuminated	-	DC12.2202.101
4	Medical Version (M5)	Snap-in	Front-Side	2-pole	non-illuminated	-	DC12.3202.101
6	Medical Version (M5)	Snap-in	Front-Side	2-pole	non-illuminated	-	DC12.4202.101
10	Medical Version (M5)	Snap-in	Front-Side	2-pole	non-illuminated	-	DC12.5202.101
1	Medical Version (M5)	Snap-in	Front-Side	2-pole	illuminated	red	DC12.1222.101
1	Medical Version (M5)	Snap-in	Front-Side	2-pole	illuminated	green	DC12.1232.101
2	Medical Version (M5)	Snap-in	Front-Side	2-pole	illuminated	red	DC12.2222.101
2	Medical Version (M5)	Snap-in	Front-Side	2-pole	illuminated	green	DC12.2232.101
4	Medical Version (M5)	Snap-in	Front-Side	2-pole	illuminated	red	DC12.3222.101
4	Medical Version (M5)	Snap-in	Front-Side	2-pole	illuminated	green	DC12.3232.101
6	Medical Version (M5)	Snap-in	Front-Side	2-pole	illuminated	red	DC12.4222.101
10	Medical Version (M5)	Snap-in	Front-Side	2-pole	illuminated	red	DC12.5222.101
10	Medical Version (M5)	Snap-in	Front-Side	2-pole	illuminated	green	DC12.5232.101
1	Medical Version (M80)	Screw	Rear-Side	2-pole	non-illuminated	-	DC12.1602.201
2	Medical Version (M80)	Screw	Rear-Side	2-pole	non-illuminated	-	DC12.2602.201
4	Medical Version (M80)	Screw	Rear-Side	2-pole	non-illuminated	-	DC12.3602.201
6	Medical Version (M80)	Screw	Rear-Side	2-pole	non-illuminated	-	DC12.4602.201
10	Medical Version (M80)	Screw	Rear-Side	2-pole	non-illuminated	-	DC12.5602.201

Packaging unit 10 Pcs

Accessories

Description

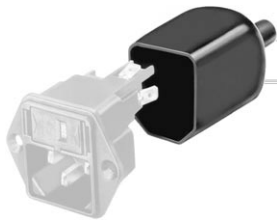

Assorted Covers  
Rear Cover

0859.0075



Cord retaining kits  
Cord retaining strain relief

Flat head, A

4700.0001

Countersunk, B

4700.0002

Mating Outlets/Connectors

Category / Description

Appliance Outlet Overview complete



IEC Appliance Outlet F, Screw-on Mounting, Front Side, Solder or Quick-connect Terminal

4787

IEC Appliance Outlet F, Snap-in Mounting, Front Side, Solder or Quick-connect Terminal

4788

IEC Appliance Outlet F or H, Screw-on Mounting, Front Side, Solder, PCB or Quick-connect Terminal

5091

IEC Appliance Outlet F or H, Screw-on Mounting, Front Side, Solder or Quick-connect Terminal

5092

Appliance Outlet further types to DC12

Connector Overview complete



IEC Connector C15, Rewireable, Straight

0101

IEC Connector C15A, Rewireable, Straight

0102

IEC Connector C15A, Rewireable, Straight

0102-G

IEC Connector C15A, Rewireable, Angled

0112

IEC Connector C13, Rewireable, Angled

4012

Connector further types to DC12

...

Power Cord Overview complete



Power Cord with IEC Connector C13, Angled

0311

Power Cord with IEC Connector C13, Angled

3011

Power Cord with IEC Connector C13, Angled

3012

Power Cord with IEC Connector C13, Angled

3013

Power Cord with IEC Connector C13

3020

Power Cord further types to DC12

...