

FEATURES

- **Low Drift**
 - A Grade: 10 ppm/°C Max
 - B Grade: 20 ppm/°C Max
- **High Accuracy**
 - A Grade: 0.05% Max
 - B Grade: 0.1% Max
- **Ultralow Supply Current: 850nA**
- High Output Drive Current: 5mA Min
- Low Dropout Voltage: 10mV Max
- Fully Specified from -40°C to 85°C
- Operational from -55°C to 125°C
- Wide Supply Range to 18V
- Reverse Input/Output Protection
- Available Output Voltage Options: 2.5V
 For 1.25V, 2.048V, 3V, 3.3V, 4.096V and 5V Options,
 Consult LTC Marketing
- Thermal Hysteresis: 25ppm
- Low Profile (1mm) ThinSOT™ Package

APPLICATIONS

- Precision A/D and D/A Converters
- Portable Gas Monitors
- Battery- or Solar-Powered Systems
- Precision Regulators
- Low Voltage Signal Processing
- Micropower Remote Sensing

DESCRIPTION

The LT®6656 is a small precision voltage reference that draws less than 1 μ A of supply current and can operate with a supply voltage within 10mV of the output voltage. The LT6656 offers an initial accuracy of 0.05% and temperature drift of 10ppm/°C. The combined low power and precision characteristics are ideal for portable and battery powered instrumentation.

The LT6656 can supply up to 5mA of output drive with 65ppm/mA of load regulation, allowing it to be used as the supply voltage and the reference input to a low power ADC. The LT6656 can accept a supply voltage up to 18V and withstand the reversal of the input connections.

The LT6656 output is stable with 1 μ F or larger output capacitance and operates with a wide range of output capacitor ESR, ensuring that the LT6656 is simple to use.

This reference is fully specified for operation from -40°C to 85°C, and is functional over the extreme temperature range of -55°C to 125°C. Low hysteresis and a consistent temperature drift are obtained through advanced design, processing and packaging techniques.

The LT6656 is offered in the 6-lead SOT-23 package.

LT, LT, LTC and LTM are registered trademarks of Linear Technology Corporation. ThinSOT is a trademark of Linear Technology Corporation. All other trademarks are the property of their respective owners.

TYPICAL APPLICATION

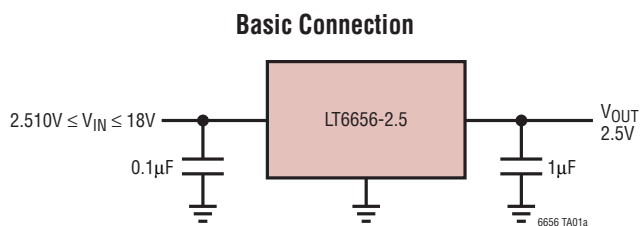

Output Voltage Temperature Drift

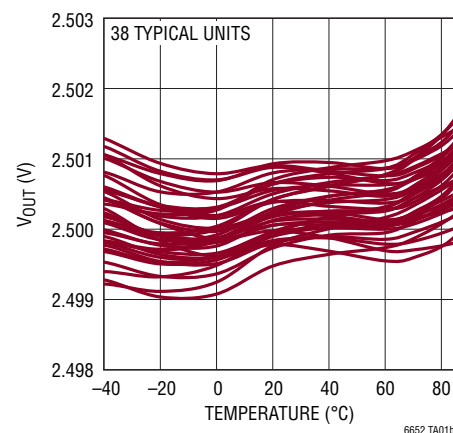

ABSOLUTE MAXIMUM RATINGS

(Note 1)

Input Voltage.....	20V
Output Voltage	-0.3V to 20V
Output Voltage Above Input Voltage	±20V
Specified Temperature Range	
Commercial	0°C to 70°C
Industrial	-40°C to 85°C
Operating Temperature Range	-55°C to 125°C
Output Short Circuit Duration	Indefinite
Junction Temperature	150°C
Storage Temperature Range (Note 2).....	-65°C to 150°C
Lead Temperature (Soldering, 10 sec.)	
(Note 3).....	300°C

PIN CONFIGURATION

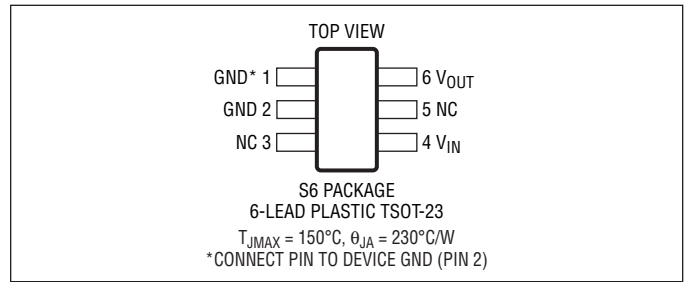

ORDER INFORMATION

LEAD FREE FINISH	TAPE AND REEL	PART MARKING*	PACKAGE DESCRIPTION	SPECIFIED TEMPERATURE RANGE
LT6656ACS6-2.5#PBF	LT6656ACS6-2.5#TRPBF	LTFGW	6-Lead Plastic TSOT-23	0°C to 70°C
LT6656BCS6-2.5#PBF	LT6656BCS6-2.5#TRPBF	LTFGW	6-Lead Plastic TSOT-23	0°C to 70°C
LT6656AIS6-2.5#PBF	LT6656AIS6-2.5#TRPBF	LTFGW	6-Lead Plastic TSOT-23	-40°C to 85°C
LT6656BIS6-2.5#PBF	LT6656BIS6-2.5#TRPBF	LTFGW	6-Lead Plastic TSOT-23	-40°C to 85°C

Consult LTC Marketing for parts specified with wider operating temperature ranges.

*The temperature and performance grades are identified by a label on the shipping container.

Consult LTC Marketing for information on non-standard lead based finish parts.

For more information on lead free part marking, go to: <http://www.linear.com/leadfree/>

For more information on tape and reel specifications, go to: <http://www.linear.com/tapeandreeel/>

AVAILABLE OPTIONS

OUTPUT VOLTAGE	INITIAL ACCURACY	TEMPERATURE COEFFICIENT	SPECIFIED TEMPERATURE RANGE	
			0°C to 70°C	-40°C to 85°C
			ORDER PART NUMBER**	ORDER PART NUMBER**
2.5V	0.05%	10ppm/°C	LT6656ACS6-2.5	LT6656AIS6-2.5
	0.1%	20ppm/°C	LT6656BCS6-2.5	LT6656BIS6-2.5

**See Order Information section for complete part number listing.

ELECTRICAL CHARACTERISTICS The ● denotes the specifications which apply over the specified temperature range, otherwise specifications are at $T_A = 25^\circ\text{C}$. $V_{IN} = V_{OUT} + 500\text{mV}$, $C_L = 1\mu\text{F}$, $I_L = 0$, unless otherwise noted. (Note 9)

PARAMETER	CONDITIONS	MIN	TYP	MAX	UNITS
Output Voltage Error	LT6656A	-0.05		0.05	%
	LT6656B	-0.10		0.10	%
Output Voltage Temperature Coefficient (Note 4)	LT6656A	●	5	10	ppm/ $^\circ\text{C}$
	LT6656B	●	12	20	ppm/ $^\circ\text{C}$
Line Regulation	$V_{IN} = (V_{OUT} + 0.5\text{V})$ to 18V	●	2	25 40	ppm/V ppm/V
Load Regulation (Note 5)	$I_{SOURCE} = 5\text{mA}$	●	65	150 375	ppm/mA ppm/mA
Dropout Voltage (Note 6)	V_{OUT} Error $\leq 0.1\%$ $I_{SOURCE} = 0\mu\text{A}$ $I_{SOURCE} = 5\text{mA}$	●	3	10	mV
		●		40	mV
		●		500	mV
Supply Current		●	0.85	1.0 1.5	μA μA
Output Short Circuit Current	Sourcing, Short V_{OUT} to GND Sinking, Short V_{OUT} to V_{IN}		18		mA
			4		mA
Input Reverse Leakage Current	$V_{IN} = -18\text{V}$, $V_{OUT} = \text{GND}$		35		μA
Reverse Output Current	$V_{IN} = \text{GND}$, $V_{OUT} = 18\text{V}$		30		μA
Output Voltage Noise (Note 7)	0.1Hz to 10Hz 10Hz to 1kHz		60		μV_{P-P}
			80		μV_{RMS}
Turn-On Time	0.1% Settling		25		ms
Long Term Drift of Output Voltage (Note 8)			50		ppm/ $\sqrt{\text{kHr}}$
Hysteresis (Note 9)	$\Delta T = 0^\circ\text{C}$ to 70°C $\Delta T = -40^\circ\text{C}$ to 85°C		25		ppm
			70		ppm

Note 1: Stresses beyond those listed under Absolute Maximum Ratings may cause permanent damage to the device. Exposure to any Absolute Maximum Rating condition for extended periods may affect device reliability and lifetime.

Note 2: If the parts are stored outside of the specified temperature range, the output may shift due to hysteresis.

Note 3: The stated temperature is typical for soldering of the leads during manual rework. For detailed IR reflow recommendations, refer to the Applications section.

Note 4: Temperature coefficient is measured by dividing the maximum change in output voltage by the specified temperature range.

Note 5: Load regulation is measured with a pulse from no load to the specified load current. Output changes due to die temperature change must be taken into account separately.

Note 6: Excludes load regulation errors.

Note 7: Peak-to-peak noise is measured with a 3-pole highpass filter at 0.1Hz and a 4-pole lowpass filter at 10Hz. The unit is enclosed in a still-air

environment to eliminate thermocouple effects on the leads. The test time is 10 seconds. RMS noise is measured on a spectrum analyzer in a shielded environment.

Note 8: Long term stability typically has a logarithmic characteristic and therefore, changes after 1000 hours tend to be much smaller than before that time. Total drift in the second thousand hours is normally less than one third that of the first thousand hours with a continuing trend toward reduced drift with time. Long-term stability will also be affected by differential stresses between the IC and the board material created during board assembly.

Note 9: Hysteresis in output voltage is created by mechanical stress that differs depending on whether the IC was previously at a higher or lower temperature. Output voltage is always measured at 25°C , but the IC is cycled to the hot or cold temperature limit before successive measurements. For instruments that are stored at well controlled temperatures (within 20 or 30 degrees of operational temperature) hysteresis is usually not a dominant error source.

TYPICAL PERFORMANCE CHARACTERISTICS

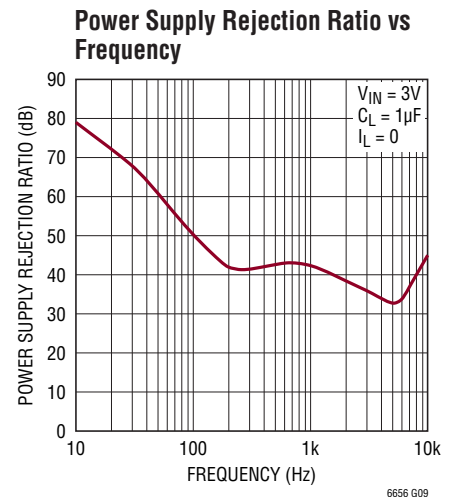
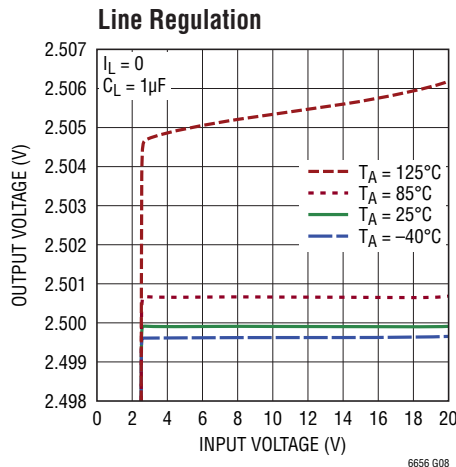
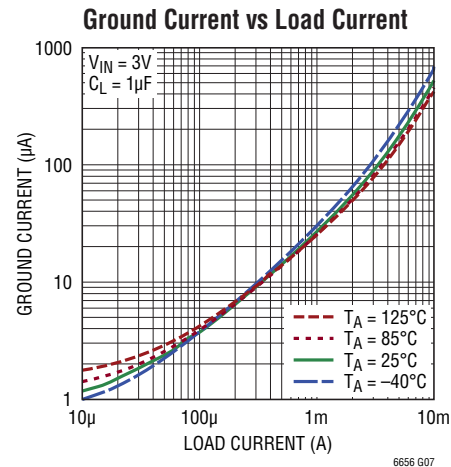
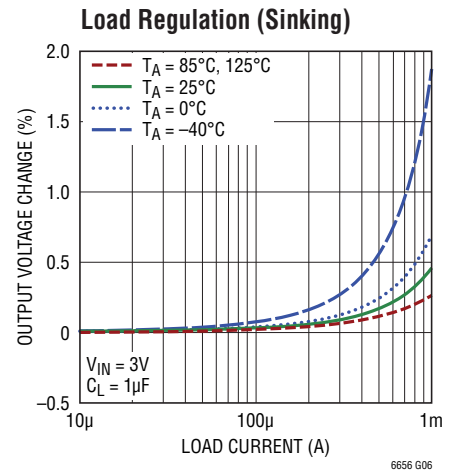
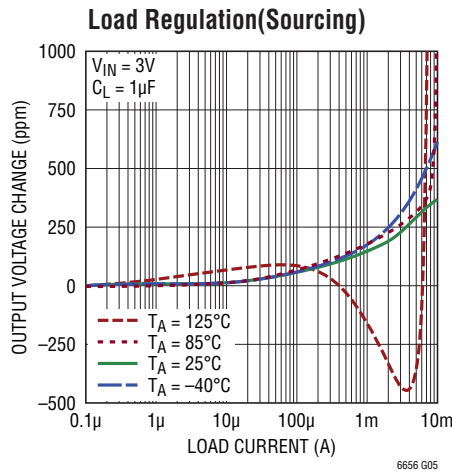
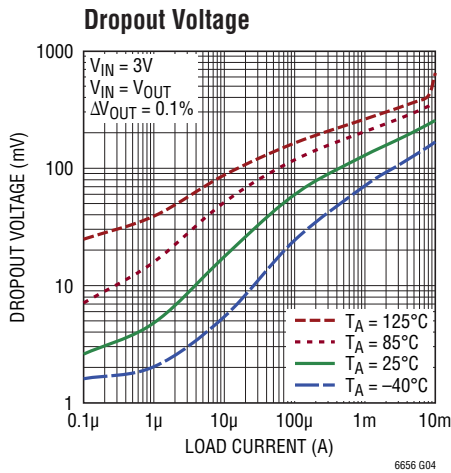
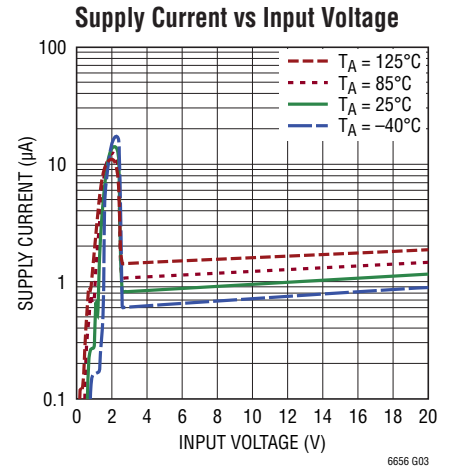
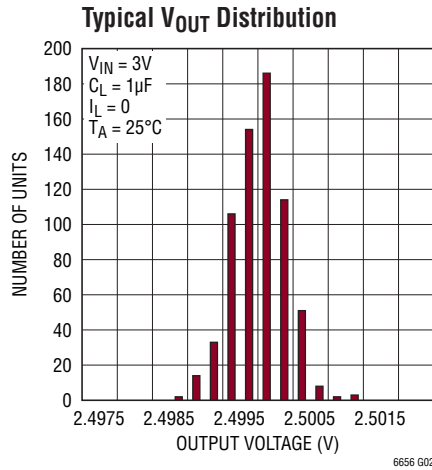
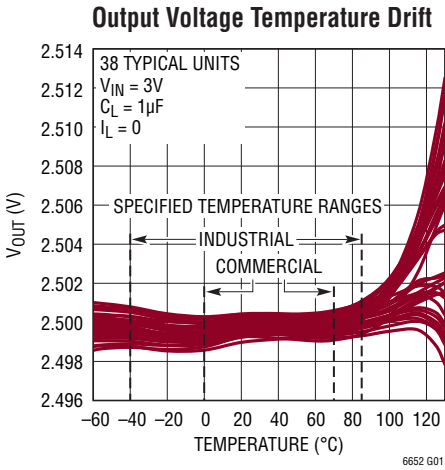

TYPICAL PERFORMANCE CHARACTERISTICS

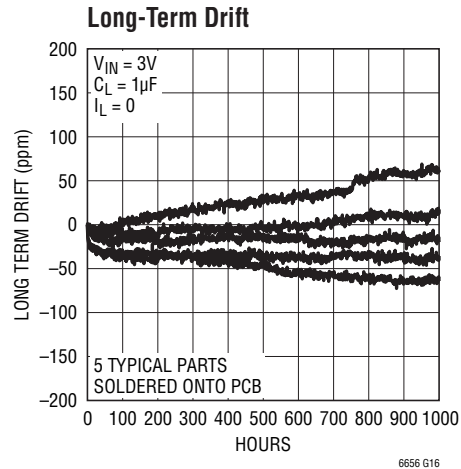
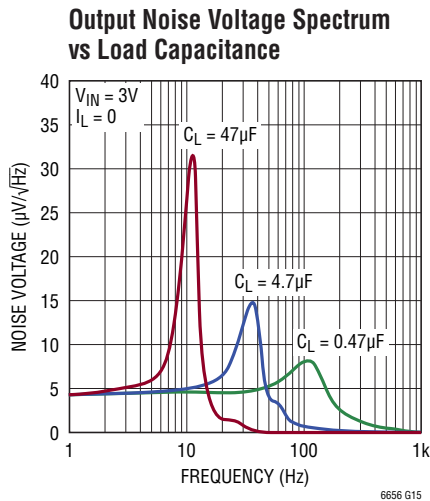
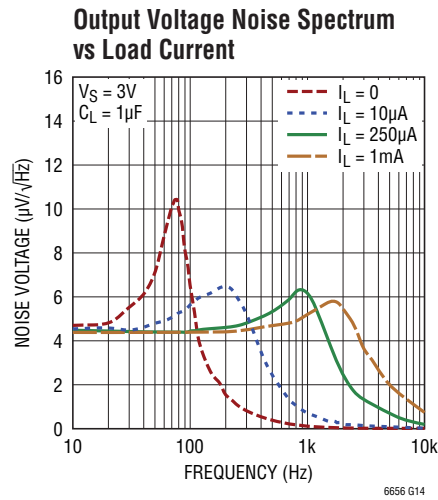
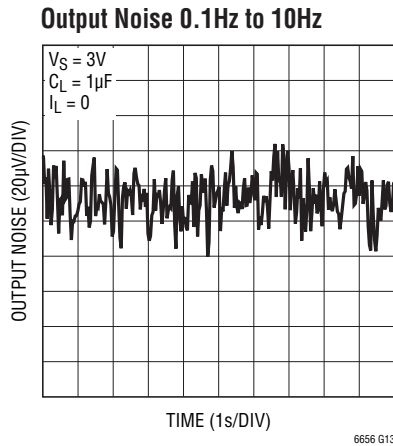
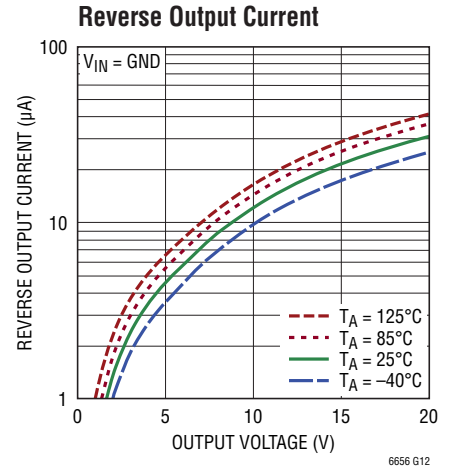
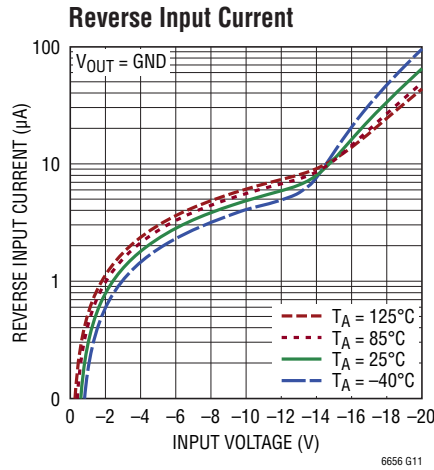
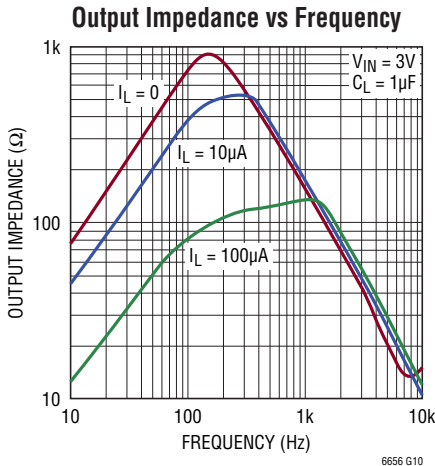

PIN FUNCTIONS

GND* (Pin 1): Internal Function. This pin must be tied to ground.

GND (Pin 2): Device Ground.

NC (Pin 3): Not internally connected. May be tied to V_{IN} , V_{OUT} , GND or floated.

V_{IN} (Pin 4): Power Supply. The minimum supply varies with output load and voltage option, see the Dropout Voltage

specification in the Electrical Characteristics table. The maximum input voltage is 18V. Bypass V_{IN} with a 0.1 μ F capacitor to ground.

NC (Pin 5): Not internally connected. May be tied to V_{IN} , V_{OUT} , GND or floated.

V_{OUT} (Pin 6): Output Voltage. A minimum output capacitor of 1 μ F is required for stable operation.

BLOCK DIAGRAM

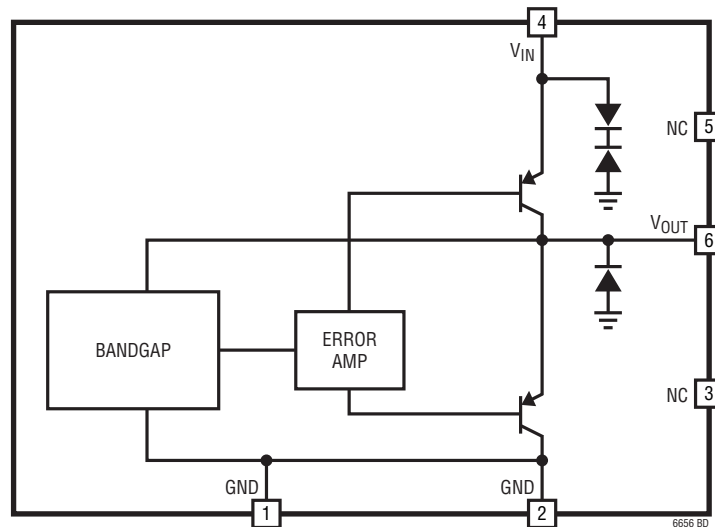

APPLICATIONS INFORMATION

Long Battery Life

Series references have a large advantage over shunt style references. Shunt references require a resistor from the power supply to operate. This resistor must be chosen to supply the maximum current that can be demanded by the load. When the load is not operating at this maximum current, the shunt reference must always sink this current, resulting in high dissipation and shortened battery life.

The LT6656 series reference does not require a current setting resistor and is specified to operate with any supply from $V_{OUT} + 10mV$ to 18V, depending on the load current and operating temperature (see Dropout Voltage in the Typical Performance Characteristics). When the load does not demand current, the LT6656 reduces its dissipation and battery life is extended. If the reference is not delivering load current, it dissipates only a few μW , yet the same connection can deliver 5mA of load current when required.

Start-Up

To ensure proper start-up, the output voltage should be between $-0.3V$ and $2.5V$. If the output load may be driven more than $0.3V$ below ground, a low forward voltage schottky diode from the output to ground is required. The turn-on characteristics can be seen in Figure 1.

Bypass and Load Capacitance

The LT6656 voltage reference needs an input bypass capacitor of $0.1\mu F$ or larger, however, the bypassing of other local devices may serve as the required component.

The output of the device requires a capacitance of $1\mu F$ or larger. With its low sensitivity to ESR, the LT6656 is stable with a wide variety of capacitor types including ceramic, tantalum and electrolytic. The test circuit in Figure 2 was used to test the response and stability of the LT6656 to various load currents. The resultant transient responses can be seen in Figure 3 and Figure 4. The large scale output response to a 500mV input step is shown in Figure 5 with a more detailed photo and description in the Output Settling section.

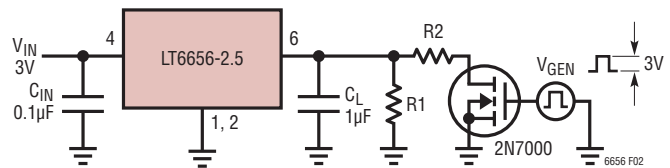

Figure 2. Transient Load Test Circuit

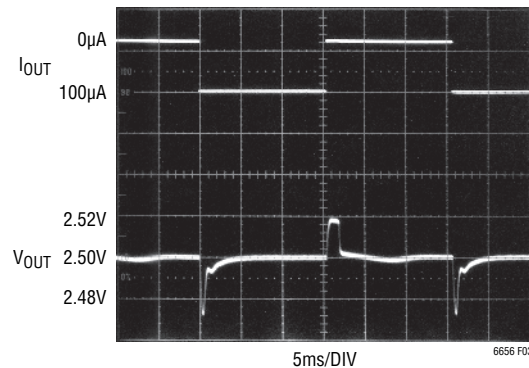

Figure 3. Transient Response, $0\mu A$ to $100\mu A$ Load Step ($R2 = 24.9k$, $R1 = \text{Open}$)

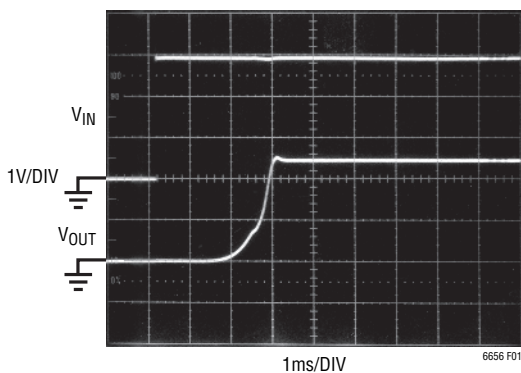

Figure 1. Turn-On Characteristics, $C_L = 1\mu F$

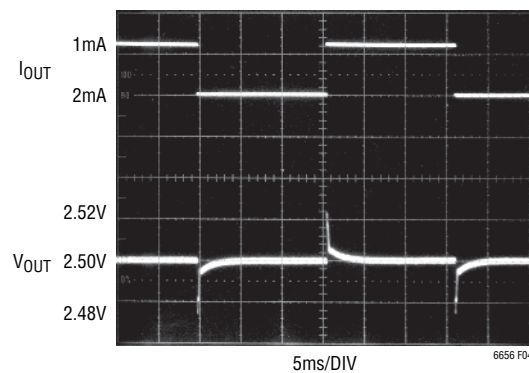

Figure 4. Transient Response, $1mA$ to $2mA$ Load Step ($R1 = R2 = 2.49k$)

APPLICATIONS INFORMATION

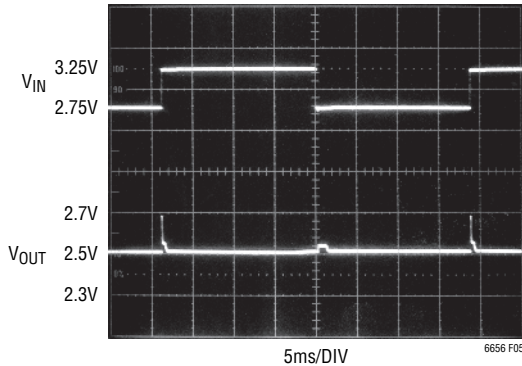

Figure 5. Output Response to 0.5Vp-p Step on VIN, CL = 1µF, IL = 0

Output Settling

The output of the LT6656 is primarily designed to source current, but is capable of sinking current to aid in output transient recovery. The output stage uses a class B architecture to minimize quiescent current, and has a typical crossover dead band of 6mV as the output transitions from sourcing to sinking current, and twice the deadband as the output transitions from sinking back to sourcing current.

The settling time is typically less than 8ms for output loads up to 5mA, however the time required to settle when the load is turned off or in response to an input transient can be significantly longer. Settling time is dominated by the ability of the application circuit to discharge the output capacitor. Larger load currents decrease settling time.

The settling time can be estimated by the following equation:

$$\text{Settling time} \approx \frac{2(\text{Deadband})(C_L)}{I_L} + 2\text{ms}$$

The graph in Figure 6 shows the settling time versus load step with no load and with a constant 2µA load applied. Note the settling time can be longer with load steps that are not large enough to activate the sinking side of the output stage.

The photo in Figure 7 shows the output response to a 0.5V input step in both a no-load and 5µA load condition. In the no-load condition only the bias current of the internal bandgap reference (about 400nA) is available to discharge the output capacitor.

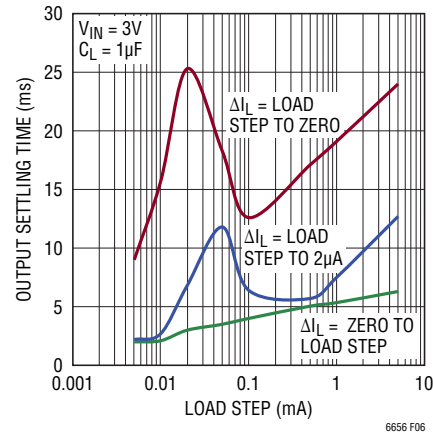

Figure 6. Output Settling Time to 0.05% vs Load Step

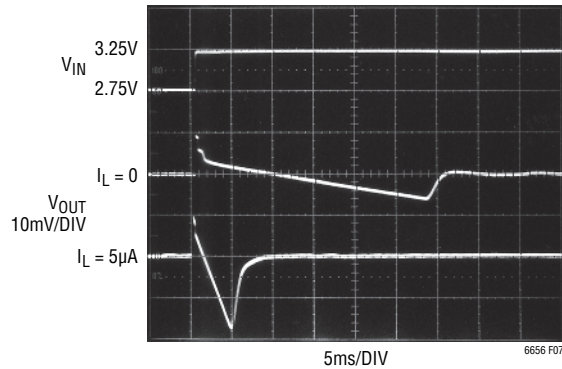

Figure 7. Detailed Output Response to a 0.5V Input Step, CIN = CL = 1µF

Output Noise

In general, output noise in the LT6656 is proportional to the bandwidth of the output stage and therefore increases with higher load current and lower output capacitance. However, peaking in the noise response may be the dominant factor in determining the output noise level. Noise peaking can be reduced by increasing the size of the output capacitor when driving heavier loads, or conversely, reducing the size of the output capacitor when driving lighter loads. Noise plots may be found in the Typical Performance Characteristics section.

Internal Protection

The LT6656 incorporates several internal protection features that make it ideal for use in battery powered systems. Reverse input protection limits the input current to typically less than 40µA when either the LT6656

APPLICATIONS INFORMATION

or the battery is installed backwards. In systems where the output can be held up by a backup battery with the input pulled to ground, the reverse output protection of the LT6656 limits the output current to typically less than 30 μ A. Should the output be pulled above the input when the LT6656 is biased, the output will typically sink 4mA. The current versus reverse voltage is shown in the Typical Performance Characteristics section.

Long-Term Drift

Long-term drift cannot be extrapolated from accelerated high temperature testing. This erroneous technique gives drift numbers that are wildly optimistic. A more realistic way to determine long-term drift is to measure it over the time interval of interest. The LT6656 drift data was taken over 100 parts that were soldered into PC boards similar to a real world application. The boards were then placed into a constant temperature oven with $T_A = 30^\circ\text{C}$, their outputs scanned regularly and measured with an 8.5 digit DVM. The parts chosen in the Long Term Drift curves in the Typical Performance Characteristics section represent high, low and typical units.

Hysteresis

Hysteresis on the LT6656 is measured in two steps, for example, from 25 $^\circ\text{C}$ to -40 $^\circ\text{C}$ to 25 $^\circ\text{C}$, then from 25 $^\circ\text{C}$ to 85 $^\circ\text{C}$ to 25 $^\circ\text{C}$, for the industrial temperature range. This two-step cycle is repeated several times and the maximum hysteresis from all the partial cycles is noted. Unlike other commonly used methods for specifying hysteresis, this ensures the worst-case hysteresis is included, whether it occurs in the first temperature excursion or the last.

Results over both commercial and industrial temperature ranges are shown in Figure 8 and Figure 9. As expected, the parts cycled over the higher temperature range have a higher hysteresis than those cycled over the lower range.

Power Dissipation

The LT6656 will not exceed the maximum junction temperature when operating within its specified temperature range of -40 $^\circ\text{C}$ to 85 $^\circ\text{C}$, maximum input voltage of 18V and specified load current of 5mA.

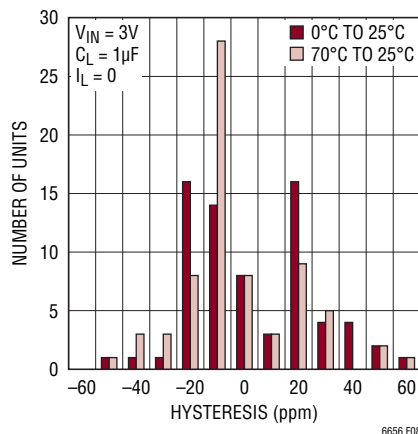

Figure 8. 0 $^\circ\text{C}$ to 70 $^\circ\text{C}$ Hysteresis

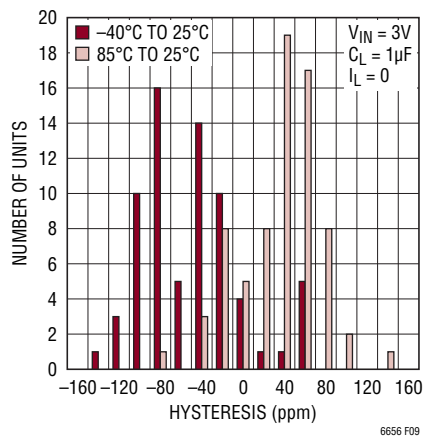

Figure 9. -40 $^\circ\text{C}$ to 85 $^\circ\text{C}$ Hysteresis

IR Reflow Shift

The different expansion and contraction rates of the materials that make up the LT6656 package induce small stresses on the die that can cause the output to shift during IR reflow. Common lead free IR reflow profiles reach over 250 $^\circ\text{C}$, considerably more than lead solder profiles. The higher reflow temperature of the lead free parts exacerbates the issue of thermal expansion and contraction causing the output shift to generally be greater than with a leaded reflow process.

The lead free IR reflow profile used to experimentally measure the output voltage shift in the LT6656-2.5 is shown in Figure 10. Similar results can be expected using a convection reflow oven. Figure 11 shows the change in output voltage that was measured for parts that were

APPLICATIONS INFORMATION

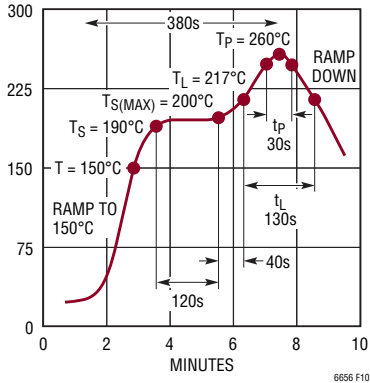

Figure 10. Lead Free Reflow Profile Due to IR Reflow

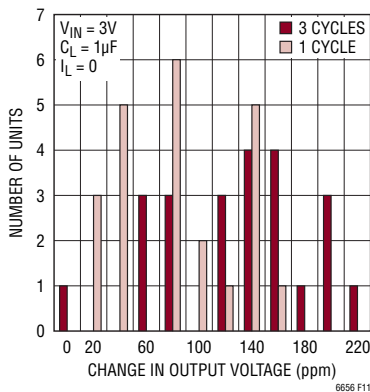

Figure 11. Output Voltage Shift Due to IR Reflow, Peak Temperature = 260°C

run through the reflow process for 1 cycle and also 3 cycles. The results indicate that the standard deviation of the output voltage increases with a positive mean shift of 120ppm. While there can be up to 220ppm of output voltage shift, additional drift of the LT6656 after IR reflow does not vary significantly.

PC Board Layout

The mechanical stress of soldering a surface mount voltage reference to a PC board can cause the output voltage to shift and temperature coefficient to change.

To reduce the effects of stress-related shifts, position the reference near the short edge of the PC board or in a corner. In addition, slots can be cut into the board on two sides of the device. See Application Note AN82 for more information. <http://www.linear.com>

The input and output capacitors should be mounted close to the package. The GND and V_{OUT} traces should be as short as possible to minimize the voltage drops caused by load and ground currents. Excessive trace resistance directly impacts load regulation.

TYPICAL APPLICATIONS

Regulator Reference

The robust input and output of the LT6656 along with its high output current make it an excellent precision low power regulator as well as a reference. The LT6656 would

be a good match with a small, low power microcontroller. Using the LT6656 as a regulator reduces power consumption, decreases solution size and increases the accuracy of the microcontroller's on board ADC.

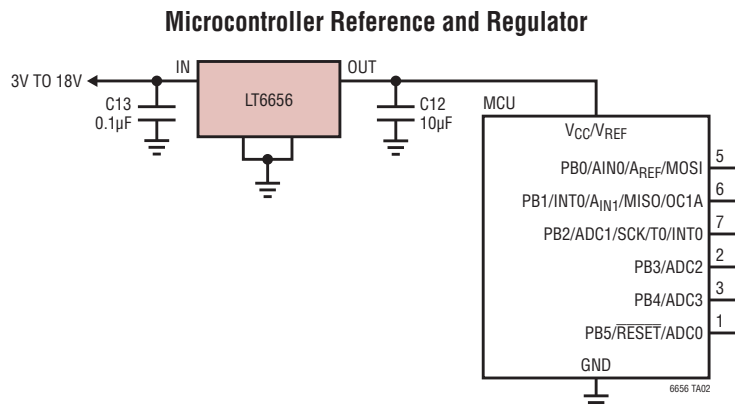

TYPICAL APPLICATIONS

Extended Supply Range Reference

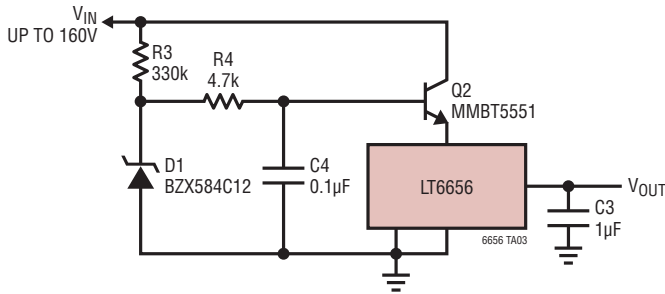

Boosted Output Current Reference

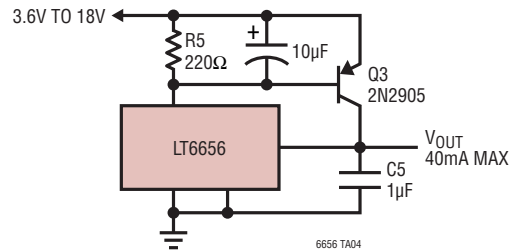

PACKAGE DESCRIPTION

**S6 Package
6-Lead Plastic TSOT-23**
(Reference LTC DWG # 05-08-1636)

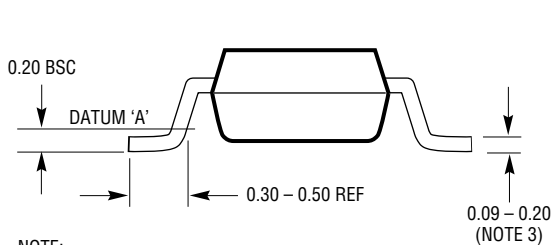
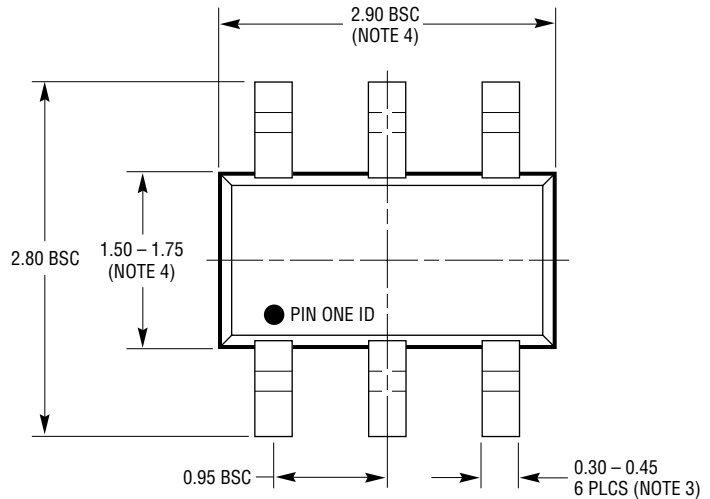
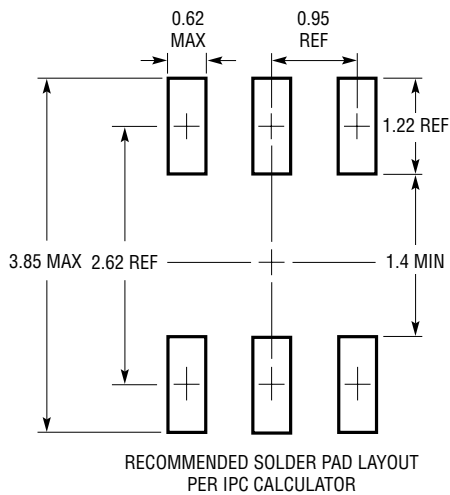

- NOTE:
1. DIMENSIONS ARE IN MILLIMETERS
 2. DRAWING NOT TO SCALE
 3. DIMENSIONS ARE INCLUSIVE OF PLATING
 4. DIMENSIONS ARE EXCLUSIVE OF MOLD FLASH AND METAL BURR
 5. MOLD FLASH SHALL NOT EXCEED 0.254mm
 6. JEDEC PACKAGE REFERENCE IS MO-193

S6 TSOT-23 0302 REV B

TYPICAL APPLICATION

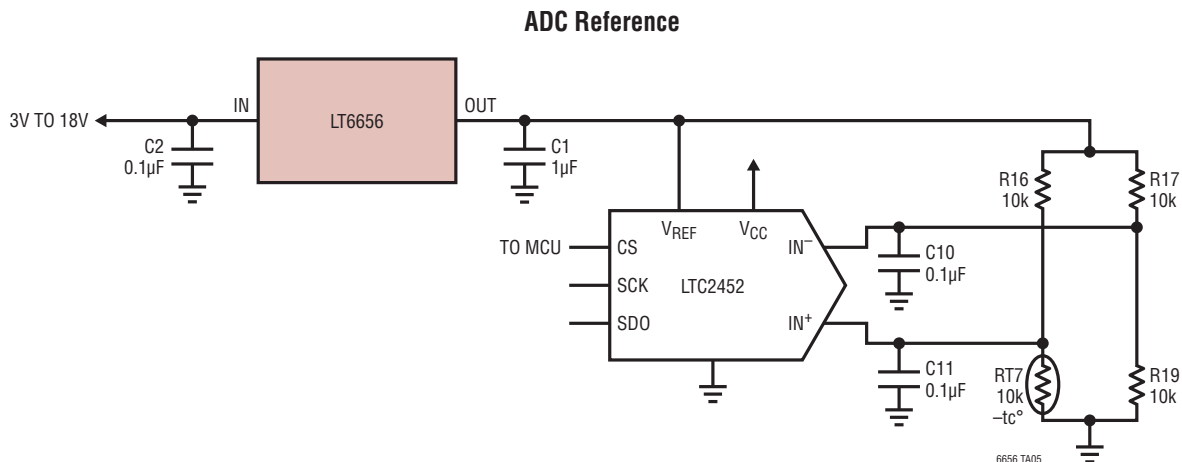

RELATED PARTS

PART NUMBER	DESCRIPTION	COMMENTS
LT1389	Nanopower Precision Shunt Voltage Reference	0.05% Max 10ppm/°C Max, 800nA Supply
LTC1440	Micropower Comparator with Reference	3.7µA Max Supply Current, 1% 1.182V Reference, MSOP, PDIP and SO-8 Packages
LT1460	Micropower Series Reference	0.075% Max, 10ppm/°C Max Drift, 2.5V, 5V and 10V Versions, MSOP, PDIP, SO-8, SOT-23 and TO-92 Packages
LT1461	Micropower Precision LDO Series Reference	3ppm/°C Max Drift, 0°C to 70°C, -40°C to 85°C, -40°C to 125°C Options in SO-8
LT1495	1.5µA Precision Rail-to-Rail Dual Op Amp	1.5µA Max Supply Current, 100pA Max IOS
LTC1540	Nanopower Comparator with Reference	600nA Max Supply Current, 2% 1.182V Reference, MSOP and SO-8 Packages
LT1634	Micropower Precision Shunt Voltage Reference	0.05% Max, 10ppm/°C Max Drift, 1.25V, 2.5V, 4.096V, 5V, 10µA Maximum Supply Current
LT1790	Micropower Precision Series Reference	0.05% Max, 10ppm/°C Max, 60µA Supply, SOT23 Package
LTC1798	6µA Low Dropout Series Reference	Available in Adjustable, 2.5V, 3V, 4.096V and 5V
LT6003	1.6V, 1µA Precision Rail-to-Rail Op Amp	1µA Max Supply Current, 1.6V Minimum Operating Voltage, SOT-23 Package
LT6650	Micropower Reference with Buffer Amplifier	0.05% Max, 5.6µA Supply, SOT-23 Package
LT6660	Tiny Micropower Series Reference	0.2% Max, 20ppm/°C Max, 20mA Output Current, 2mm × 2mm DFN
LT6700	Micropower, Low Voltage Dual Comparator with 40mV Reference	6.5µA Supply Current, 1.4V Minimum Operating Voltage