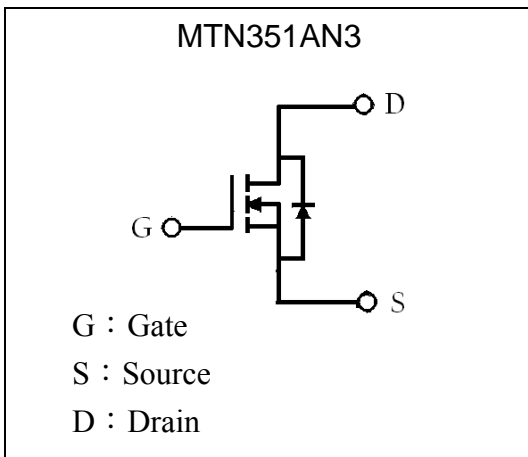
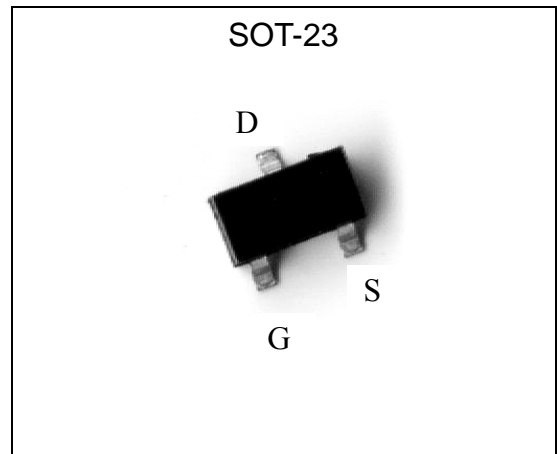

30V N-CHANNEL Enhancement Mode MOSFET

MTN351AN3

Features

- $V_{DS}=30V$
 $R_{DS(ON)}=60m\Omega @V_{GS}=10V, I_D=3A$
 $R_{DS(ON)}=100m\Omega @V_{GS}=4.5V, I_D=2A$
- Lower gate charge
- Compact and low profile SOT-23 package

Equivalent Circuit

Outline

Absolute Maximum Ratings (Ta=25°C)

Parameter	Symbol	Limits	Unit
Drain-Source Voltage	V_{DS}	30	V
Gate-Source Voltage	V_{GS}	± 20	V
Continuous Drain Current	I_D	3 (Note 1)	A
Pulsed Drain Current	I_{DM}	10 (Note 2 & 3)	A
Maximum Power Dissipation	P_D	1.38	W
Linear Derating Factor		0.01	W/°C
Thermal Resistance, Junction to Ambient	$R_{th, j-a}$	90 (Note 1)	°C/W
Operating Junction and Storage Temperature	T_j, T_{stg}	-55 ~ +150	°C

Note : 1. Surface mounted on 1 in² copper pad of FR4 board; 270°C/W when mounted on min. copper pad

2. Pulse width limited by maximum junction temperature

3. Pulse width $\leq 300\mu s$, duty cycle $\leq 2\%$



Electrical Characteristics (Tj=25°C, unless otherwise specified)

Symbol	Min.	Typ.	Max.	Unit	Test Conditions
Static					
BV _{DSS}	30	-	-	V	V _{GS} =0, I _D =250μA
ΔBV _{DSS} /ΔT _j	-	0.1	-	V/°C	Reference to 25°C, I _D =1mA
V _{GS(th)}	1.0	-	2.5	V	V _{DS} =V _{GS} , I _D =250μA
I _{GSS}	-	-	±100	nA	V _{GS} =±20V, V _{DS} =0
I _{DSS}	-	-	1	μA	V _{DS} =30V, V _{GS} =0
	-	-	10	μA	V _{DS} =24V, V _{GS} =0, T _j =55°C
*R _{DS(ON)}	-	-	60	mΩ	I _D =3A, V _{GS} =10V
	-	-	100		I _D =2A, V _{GS} =4.5V
*G _{FS}	-	13	-	S	V _{DS} =5V, I _D =3A
Dynamic					
C _{iSS}	-	660	-	pF	V _{DS} =25V, V _{GS} =0, f=1MHz
C _{oSS}	-	90	-		
C _{rSS}	-	70	-		
*t _{d(ON)}	-	6	-	ns	V _{DS} =15V, I _D =3A, R _D =3 Ω V _{GS} =10V, R _G =3.3 Ω
*t _r	-	20	-		
*t _{d(OFF)}	-	20	-		
*t _f	-	3	-		
*Q _g	-	8.5	-	nC	V _{DS} =16V, I _D =3A, V _{GS} =4.5V
*Q _{gs}	-	1.5	-		
*Q _{gd}	-	3.2	-		
R _g	-	0.9	-	Ω	V _{GS} =15mV, f=1MHz
Source-Drain Diode					
*V _{SD}	-	-	1.2	V	V _{GS} =0V, I _S =1.2A
*t _{rr}	-	14	-	ns	I _S =3A, V _{GS} =0V, dI/dt=100A/μs
*Q _{rr}	-	7	-	nC	

*Pulse Test : Pulse Width ≤300μs, Duty Cycle≤2%

Ordering Information

Device	Package	Shipping	Marking
MTN351AN3	SOT-23 (Pb-free)	3000 pcs / Tape & Reel	351AN

Characteristic Curves

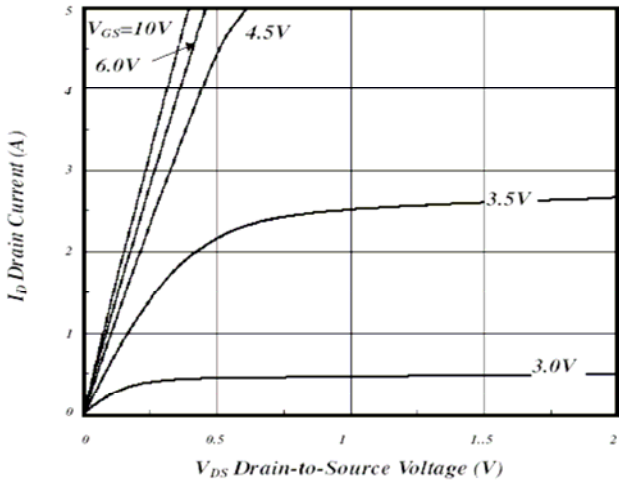

Fig 1. Typical Output Characteristics

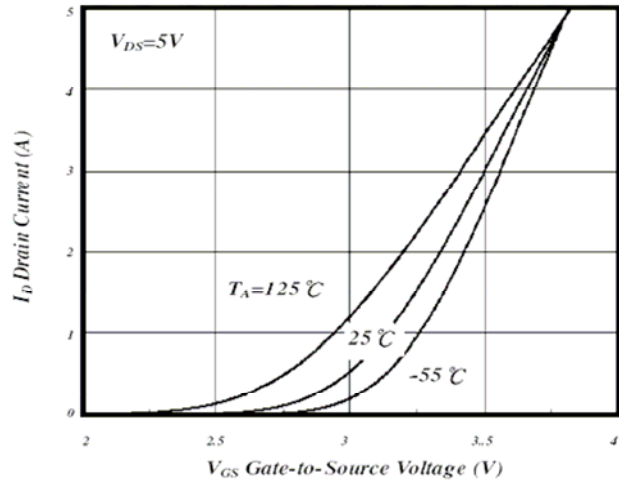

Fig 2. Transfer Characteristics

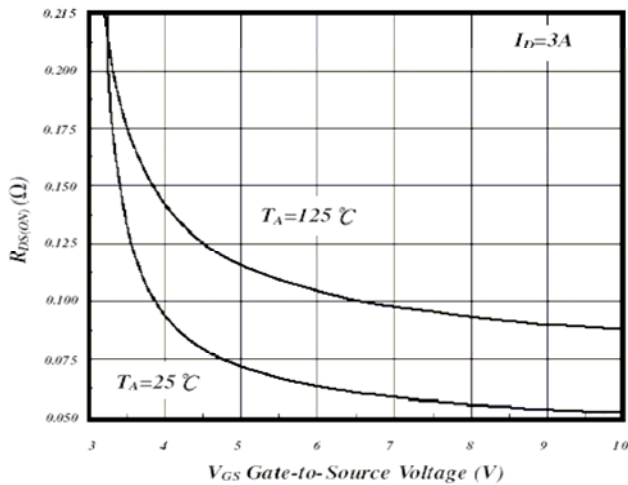

Fig 3. On-Resistance vs. Gate Voltage

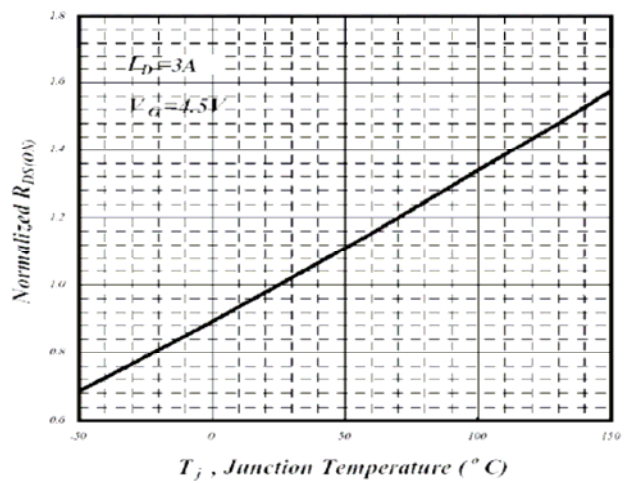

Fig 4. Normalized On-Resistance vs. Junction Temperature

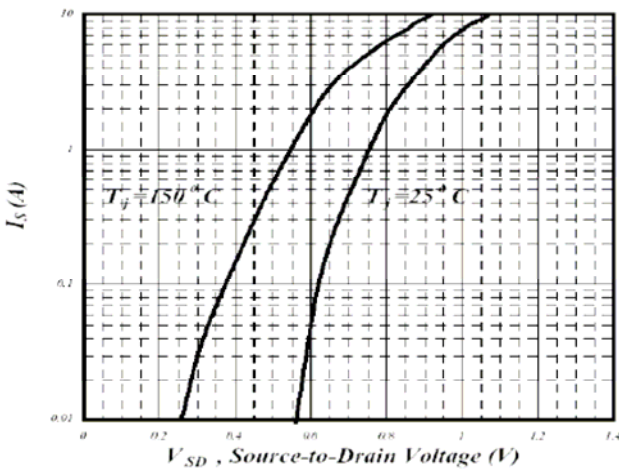

Fig 5. Forward Characteristics of Reverse Diode

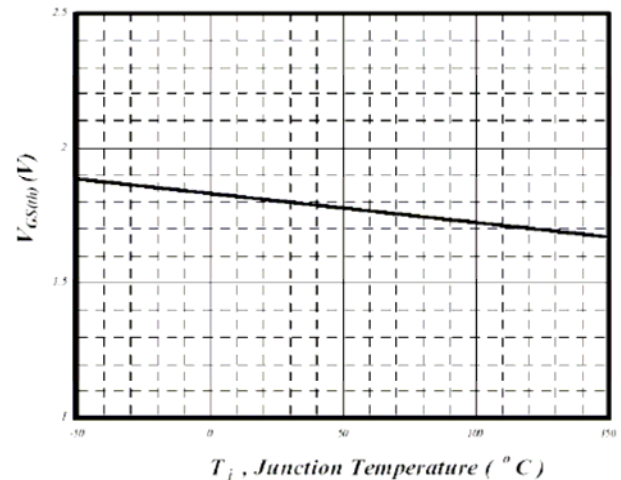

Fig 6. Gate Threshold Voltage vs. Junction Temperature

Characteristic Curves(Cont.)

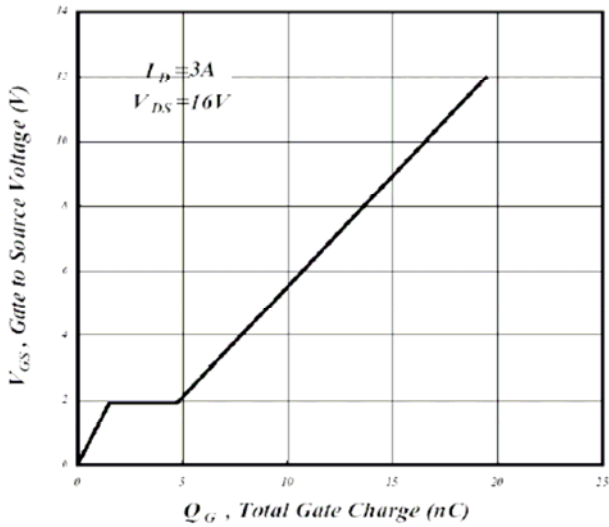

Fig 7. Gate Charge Characteristics

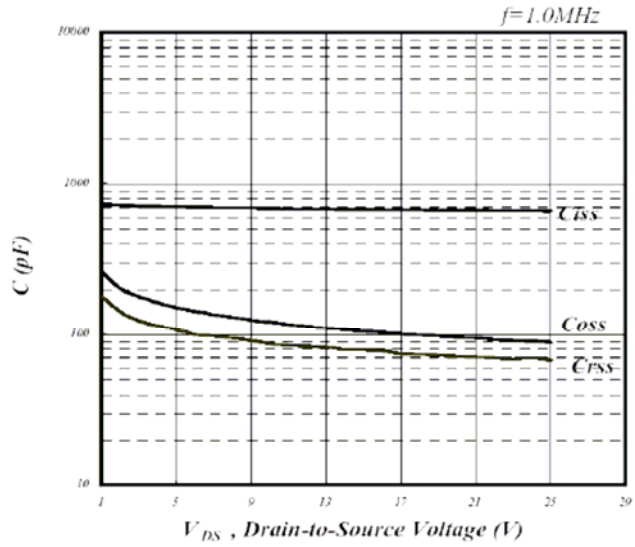

Fig 8. Typical Capacitance Characteristics

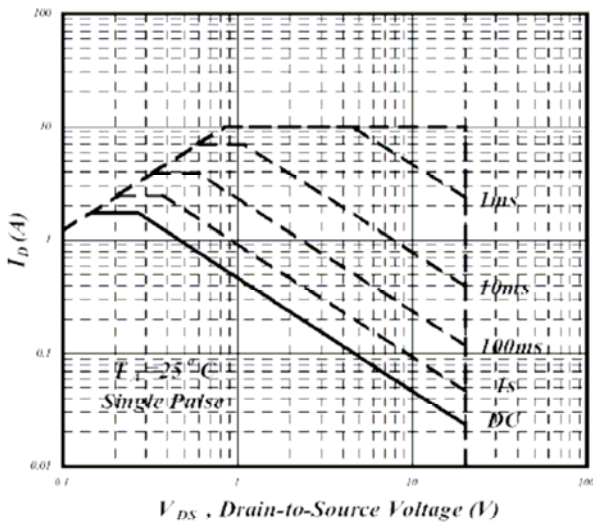

Fig 9. Maximum Safe Operating Area

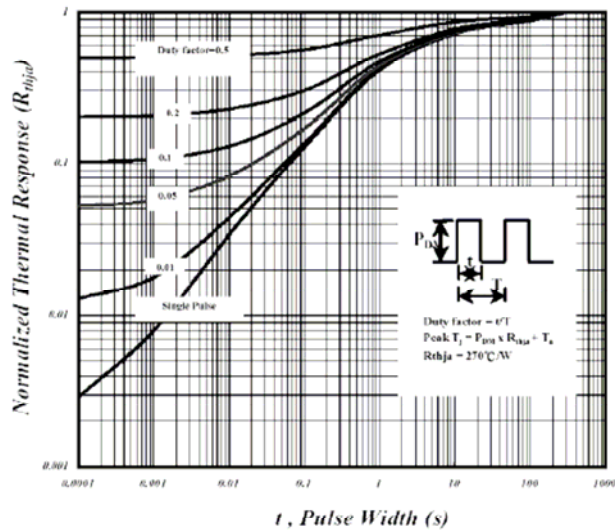

Fig 10. Effective Transient Thermal Impedance

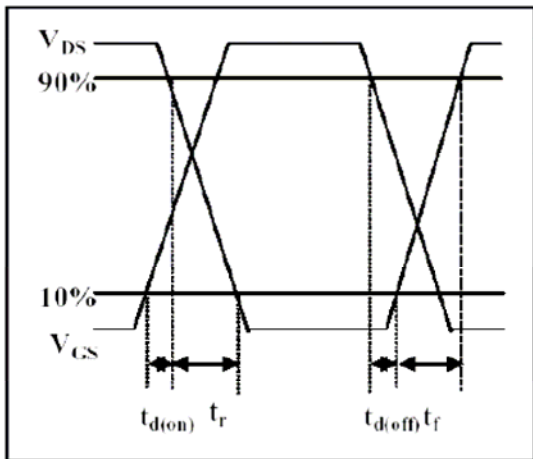

Fig 11. Switching Time Waveform

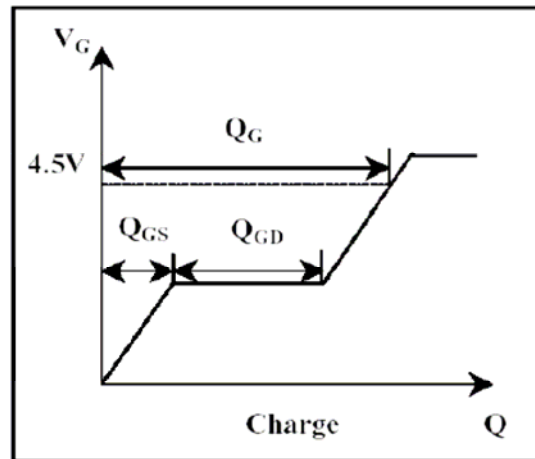
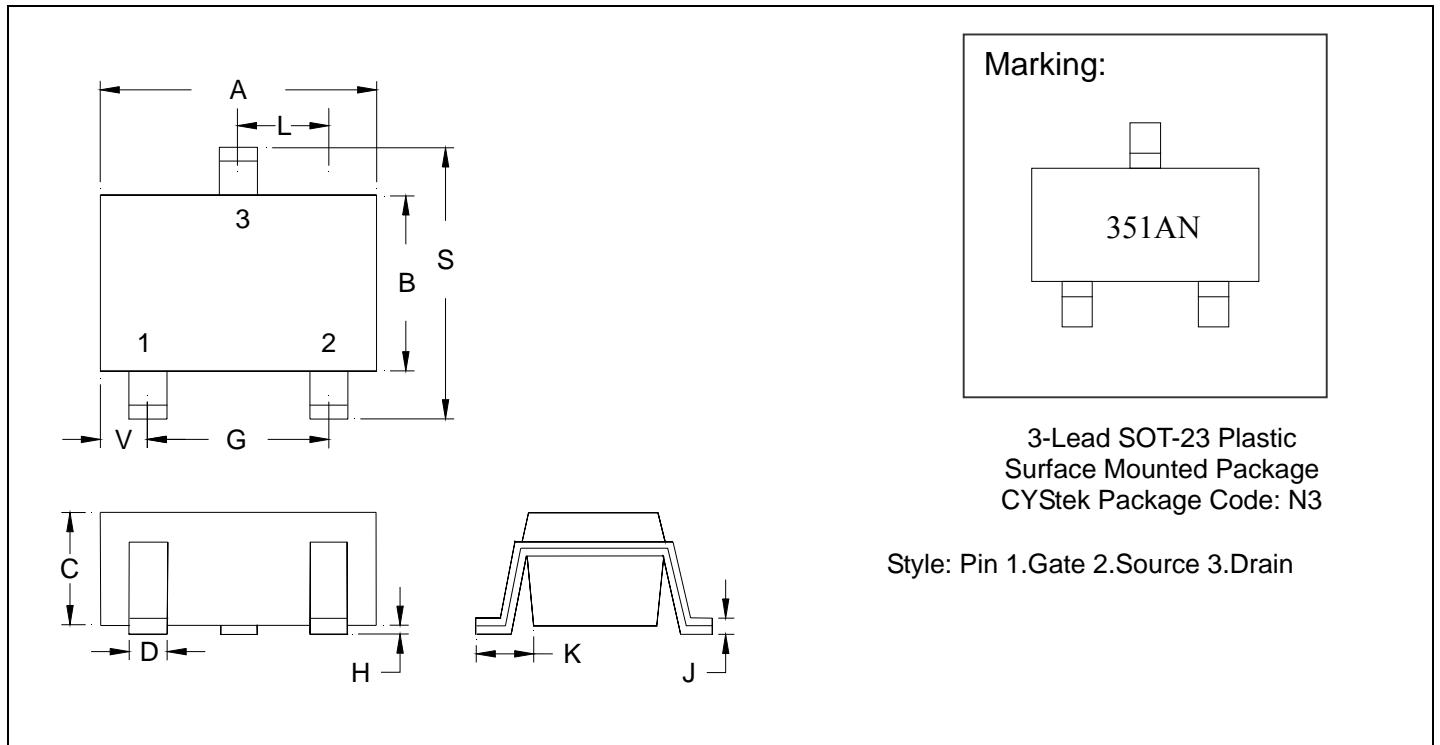

Fig 12. Gate Charge Waveform

SOT-23 Dimension



*: Typical

DIM	Inches		Millimeters		DIM	Inches		Millimeters	
	Min.	Max.	Min.	Max.		Min.	Max.	Min.	Max.
A	0.1102	0.1204	2.80	3.04	J	0.0034	0.0070	0.085	0.177
B	0.0472	0.0630	1.20	1.60	K	0.0128	0.0266	0.32	0.67
C	0.0335	0.0512	0.89	1.30	L	0.0335	0.0453	0.85	1.15
D	0.0118	0.0197	0.30	0.50	S	0.0830	0.1083	2.10	2.75
G	0.0669	0.0910	1.70	2.30	V	0.0098	0.0256	0.25	0.65
H	0.0005	0.0040	0.013	0.10					

- Notes:**
- Controlling dimension: millimeters.
 - Maximum lead thickness includes lead finish thickness, and minimum lead thickness is the minimum thickness of base material.
 - If there is any question with packing specification or packing method, please contact your local CYStek sales office.

Material:

- Lead: 42 Alloy ; solder plating
- Mold Compound: Epoxy resin family, flammability solid burning class: UL94V-0

Important Notice:

- All rights are reserved. Reproduction in whole or in part is prohibited without the prior written approval of CYStek.
- CYStek reserves the right to make changes to its products without notice.
- CYStek **semiconductor products are not warranted to be suitable for use in Life-Support Applications, or systems.**
- CYStek assumes no liability for any consequence of customer product design, infringement of patents, or application assistance.