

Tiny 500mA, 4MHz/2MHz Synchronous Step-Down DC-DC Converters

General Description

The MAX8640Y/MAX8640Z step-down converters are optimized for applications where small size, high efficiency, and low output ripple are priorities. They utilize a proprietary PWM control scheme that optimizes the switching frequency for high efficiency with small external components and maintains low output ripple voltage at all loads. The MAX8640Z switches at up to 4MHz to allow a tiny 1 μ H inductor and 2.2 μ F output capacitor. The MAX8640Y switches at up to 2MHz for higher efficiency while still allowing small 2.2 μ H and 4.7 μ F components. Output current is guaranteed up to 500mA, while typical quiescent current is 28 μ A. Factory-preset output voltages from 0.8V to 2.5V eliminate external feedback components.

Internal synchronous rectification greatly improves efficiency and replaces the external Schottky diode required in conventional step-down converters. Internal fast soft-start eliminates inrush current so as to reduce input capacitor requirements.

The MAX8640Y/MAX8640Z are available in the tiny 6-pin, SC70 (2.0mm x 2.1mm) and μ DFN (1.5mm x 1.0mm) packages. Both packages are lead-free.

Applications

Microprocessor/DSP Core Power
I/O Power
Cell Phones, PDAs, DSCs, MP3s
Other Handhelds Where Space Is Limited

Features

- ◆ Tiny SC70 and μ DFN Packages
- ◆ 500mA Guaranteed Output Current
- ◆ 4MHz or 2MHz PWM Switching Frequency
- ◆ Tiny External Components: 1 μ H/2.2 μ F or 2.2 μ H/4.7 μ F
- ◆ 28 μ A Quiescent Current
- ◆ Factory Preset Outputs from 0.8V to 2.5V
- ◆ $\pm 1\%$ Initial Accuracy
- ◆ Low Output Ripple at All Loads
- ◆ Ultrasonic Skip Mode Down to 1mA Loads
- ◆ Ultra-Fast Line- and Load-Transient Response
- ◆ Fast Soft-Start Eliminates Inrush Current

Ordering Information

PART*	PIN-PACKAGE	TOP MARK
MAX8640YEXT08+T	6 SC70	ACQ
MAX8640YEXT10+T	6 SC70	ADF
MAX8640YEXT11+T	6 SC70	ACR
MAX8640YEXT12+T	6 SC70	ACS
MAX8640YEXT13+T	6 SC70	ACG
MAX8640YEXT15+T	6 SC70	ADD
MAX8640YEXT16+T	6 SC70	ADB
MAX8640YEXT18+T	6 SC70	ACI
MAX8640YEXT19+T	6 SC70	ACH
MAX8640YEXT82+T	6 SC70	ADJ

*Contact factory for availability of each version. For 2.85V output (82 version), request application note that includes limitations and typical operating characteristics.

+Denotes a lead(Pb)-free/RoHS-compliant package.

T = Tape and reel.

Note: All devices are specified over the -40°C to +85°C operating temperature range.

Ordering Information continued and Selector Guide appears at end of data sheet.

Typical Operating Circuit

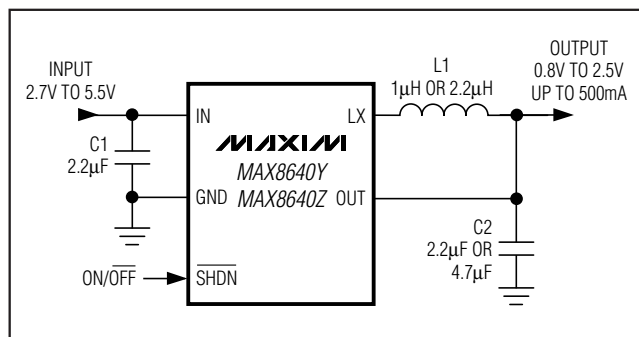

Pin Configurations

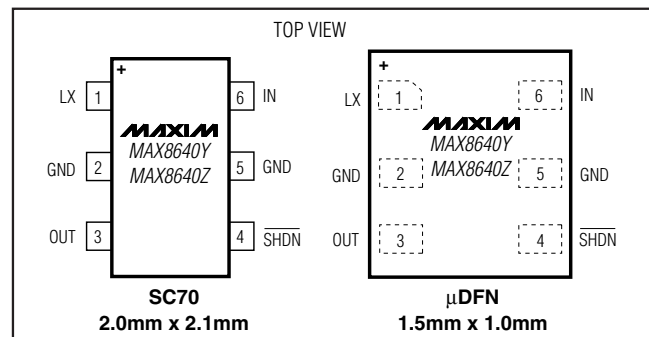

Tiny 500mA, 4MHz/2MHz Synchronous Step-Down DC-DC Converters

ABSOLUTE MAXIMUM RATINGS

IN to GND	-0.3V to +6V	6-Pin μ DFN (derate 2.1mW/°C above +70°C)	167.7mW
OUT, SHDN to GND	-0.3V to (VIN + 0.3V)	Operating Temperature Range	-40°C to +85°C
LX Current (Note 1)	0.8ARMS	Junction Temperature	+150°C
OUTPUT Short Circuit to GND	Continuous	Storage Temperature Range	-65°C to +150°C
Continuous Power Dissipation (TA = +70°C)		Lead Temperature (soldering, 10s)	+300°C
6-Pin SC70 (derate 3.1mW/°C above +70°C)	245mW		

Note 1: LX has internal clamp diodes to IN and GND. Applications that forward bias these diodes should not exceed the IC's package power-dissipation limit.

Stresses beyond those listed under "Absolute Maximum Ratings" may cause permanent damage to the device. These are stress ratings only, and functional operation of the device at these or any other conditions beyond those indicated in the operational sections of the specifications is not implied. Exposure to absolute maximum rating conditions for extended periods may affect device reliability.

ELECTRICAL CHARACTERISTICS

(VIN = 3.6V, SHDN = IN, TA = -40°C to +85°C, typical values are at TA = +25°C, unless otherwise noted.) (Note 2)

PARAMETER	SYMBOL	CONDITIONS	MIN	TYP	MAX	UNITS
Supply Range	VIN		2.7		5.5	V
UVLO Threshold	UVLO	VIN rising, 100mV hysteresis	2.44	2.6	2.70	V
Supply Current	ICC	No load, no switching		28	48	μ A
		SHDN = GND	TA = +25°C	0.01	0.1	
			TA = +85°C	0.1		
Output Voltage Range	VOUT	Factory preset	0.8		2.5	V
Output Voltage Accuracy (Falling Edge)		ILOAD = 0mA, TA = +25°C	-1	0	+1	%
		ILOAD = 0mA, TA = -40°C to +85°C	-2		+2	
Output Load Regulation (Voltage Positioning)		Equal to inductor DC resistance		RL		V/A
SHDN Logic Input Level	VIH	VIN = 2.7V to 5.5V	1.4			V
	VIL	VIN = 2.7V to 5.5V			0.4	
SHDN Logic Input Bias Current	IIH,IL	VIN = 5.5V, SHDN = GND or IN	TA = +25°C	0.001	1	μ A
			TA = +85°C	0.01		
Peak Current Limit	ILIMP	pFET switch	590	770	1400	mA
Valley Current Limit	ILIMN	nFET rectifier	450	650	1300	mA
Rectifier Off-Current Threshold	ILXOFF	nFET rectifier	10	40	70	mA
On-Resistance	RONP	pFET switch, ILX = -40mA		0.6	1.2	Ω
	RONN	nFET rectifier, ILX = 40mA		0.35	0.7	
LX Leakage Current	ILXLKG	VIN = 5.5V, LX = GND to IN, SHDN = GND	TA = +25°C	0.1	1	μ A
			TA = +85°C	1		
Minimum On and Off Times	tON(MIN)			95		ns
	tOFF(MIN)			95		
Thermal Shutdown				+160		°C
Thermal-Shutdown Hysteresis				20		°C

Note 2: All devices are 100% production tested at TA = +25°C. Limits over the operating temperature range are guaranteed by design.

Tiny 500mA, 4MHz/2MHz Synchronous Step-Down DC-DC Converters

Typical Operating Characteristics

($V_{IN} = 3.6V$, $V_{OUT} = 1.5V$, MAX8640Z, L = Murata LQH32CN series, $T_A = +25^\circ C$, unless otherwise noted.)

MAX8640Y/MAX8640Z

**EFFICIENCY vs. LOAD CURRENT
1.8V OUTPUT**

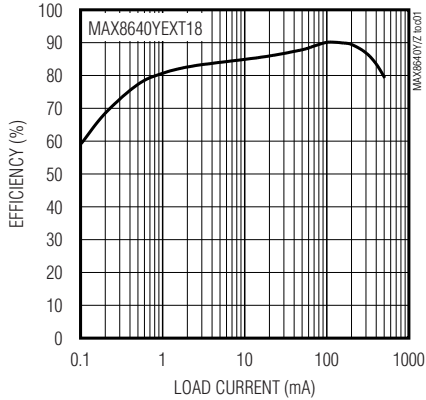

**NO-LOAD SUPPLY CURRENT
vs. SUPPLY VOLTAGE**

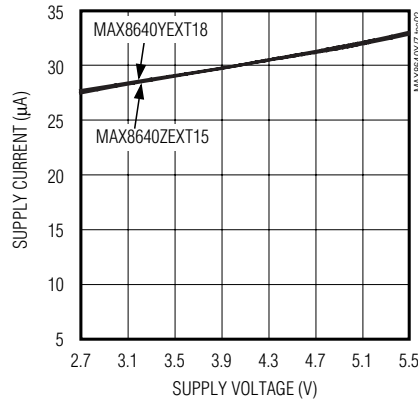

**SWITCHING FREQUENCY
vs. LOAD CURRENT**

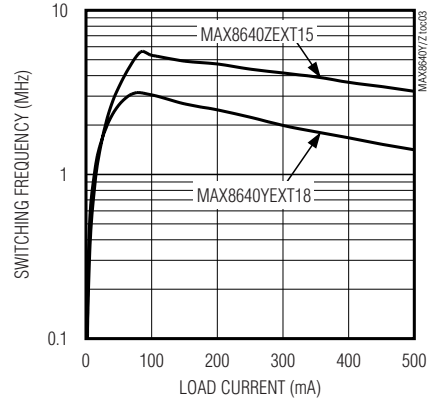

**OUTPUT VOLTAGE vs. LOAD CURRENT
(VOLTAGE POSITIONING)**

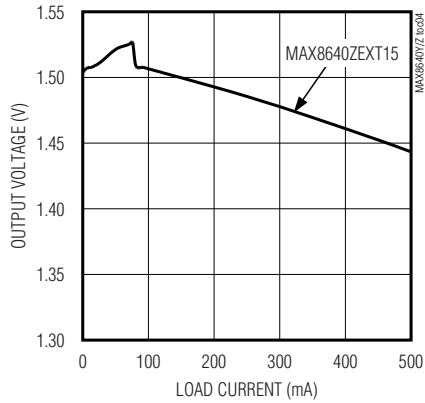

**LIGHT-LOAD SWITCHING WAVEFORMS
($I_{OUT} = 1mA$)**

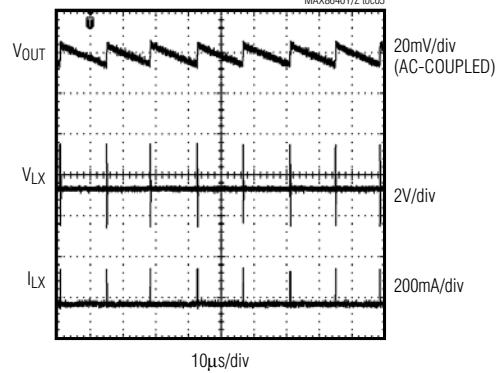

**MEDIUM-LOAD SWITCHING WAVEFORMS
($I_{OUT} = 40mA$)**

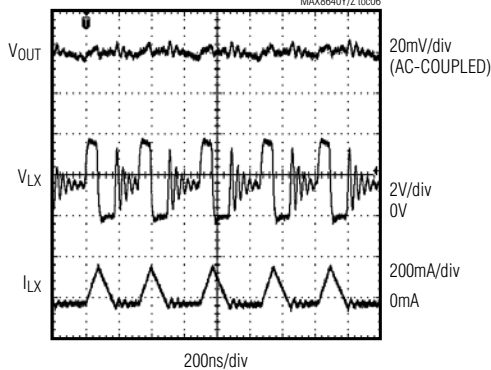

**HEAVY-LOAD SWITCHING WAVEFORMS
($I_{OUT} = 300mA$)**

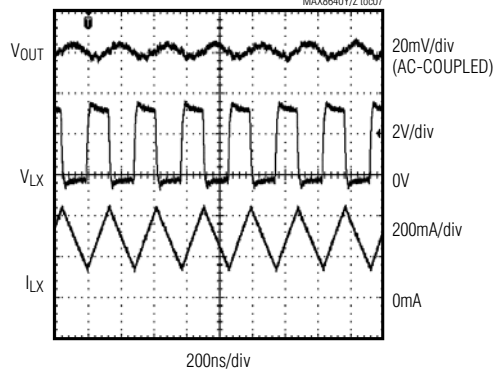

Tiny 500mA, 4MHz/2MHz Synchronous Step-Down DC-DC Converters

Typical Operating Characteristics (continued)

($V_{IN} = 3.6V$, $V_{OUT} = 1.5V$, MAX8640Z, L = Murata LQH32CN series, $T_A = +25^\circ C$, unless otherwise noted.)

**LIGHT-LOAD STARTUP WAVEFORM
(100Ω LOAD)**

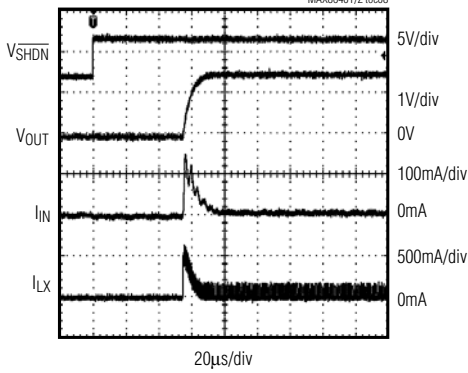

**HEAVY-LOAD STARTUP WAVEFORM
(5Ω LOAD)**

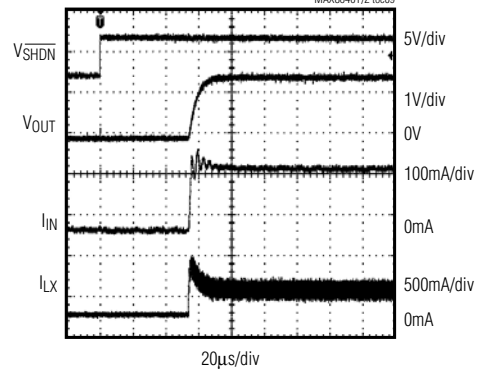

**LINE-TRANSIENT RESPONSE
(4V TO 3.5V TO 4V)**

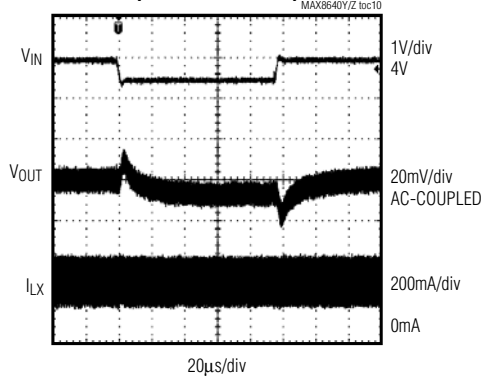

**LOAD-TRANSIENT RESPONSE
(5mA TO 250mA TO 5mA)**

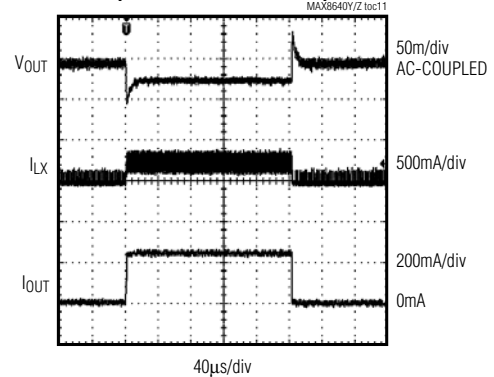

**LOAD-TRANSIENT RESPONSE
(10mA TO 500mA TO 10mA)**

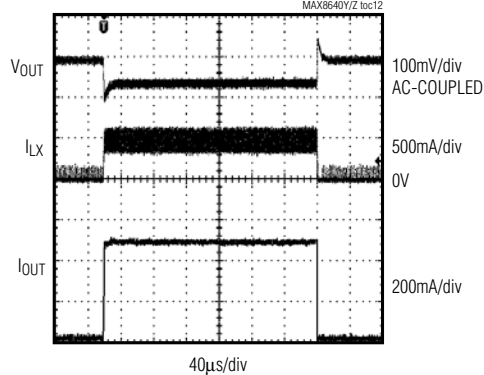

Tiny 500mA, 4MHz/2MHz Synchronous Step-Down DC-DC Converters

Pin Description

PIN	NAME	FUNCTION
1	LX	Inductor Connection to the Internal Drains of the p-channel and n-channel MOSFETs. High impedance during shutdown.
2, 5	GND	Ground. Connect these pins together directly under the IC.
3	OUT	Output Sense Input. Bypass with a ceramic capacitor as close as possible to pin 3 (OUT) and pin 2 (GND). OUT is internally connected to the internal feedback network.
4	$\overline{\text{SHDN}}$	Active-Low Shutdown Input. Connect to IN or logic-high for normal operation. Connect to GND or logic-low for shutdown mode.
6	IN	Supply Voltage Input. Input voltage range is 2.7V to 5.5V. Bypass with a ceramic capacitor as close as possible to pin 6 (IN) and pin 5 (GND).

Detailed Description

The MAX8640Y/MAX8640Z step-down converters deliver over 500mA to outputs from 0.8V to 2.5V. They utilize a proprietary hysteretic PWM control scheme that switches at up to 4MHz (MAX8640Z) or 2MHz (MAX8640Y), allowing some trade-off between efficiency and size of external components. At loads below 100mA, the MAX8640Y/MAX8640Z automatically switch to pulse-skipping mode to minimize the typical quiescent current (28 μ A). Output ripple remains low at all loads, while the skip-mode switching frequency remains ultrasonic down to 1mA (typ) loads. Figure 1 is the simplified functional diagram.

Control Scheme

A proprietary hysteretic PWM control scheme ensures high efficiency, fast switching, fast transient response, low output ripple, and physically tiny external components. This control scheme is simple: when the output voltage is below the regulation threshold, the error comparator begins a switching cycle by turning on the high-side switch. This switch remains on until the minimum on-time expires and the output voltage is above the regulation threshold or the inductor current is above the current-limit threshold. Once off, the high-side switch remains off until the minimum off-time expires and the output voltage falls again below the regulation threshold. During the off period, the low-side synchronous rectifier turns on and remains on until either the high-side switch turns on again or the inductor current approaches zero. The internal synchronous rectifier eliminates the need for an external Schottky diode.

Voltage-Positioning Load Regulation

The MAX8640Y/MAX8640Z utilize a unique feedback network. By taking DC feedback from the LX node, the usual phase lag due to the output capacitor is removed, making the loop exceedingly stable and

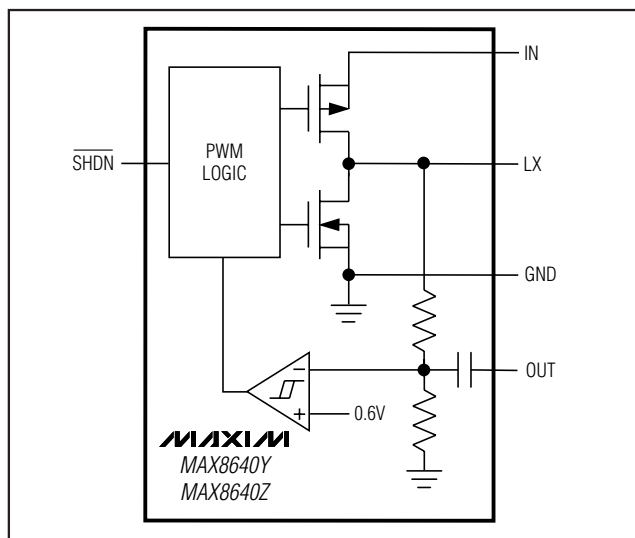

Figure 1. Simplified Functional Diagram

allowing the use of very small ceramic output capacitors. This configuration yields load regulation equal to the inductor's series resistance multiplied by the load current. This voltage-positioning load regulation greatly reduces overshoot during load transients, effectively halving the peak-to-peak output-voltage excursions compared to traditional step-down converters. See the Load-Transient Response in the *Typical Operating Characteristics*.

Shutdown Mode

Connecting $\overline{\text{SHDN}}$ to GND or logic low places the MAX8640Y/MAX8640Z in shutdown mode and reduces supply current to 0.1 μ A (typ). In shutdown, the control circuitry and internal MOSFET switches turn off and LX becomes high impedance. Connect $\overline{\text{SHDN}}$ to IN or logic high for normal operation.

Tiny 500mA, 4MHz/2MHz Synchronous Step-Down DC-DC Converters

Soft-Start

The MAX8640Y/MAX8640Z include internal soft-start circuitry that eliminates inrush current at startup, reducing transients on the input source. Soft-start is particularly useful for higher impedance input sources, such as Li+ and alkaline cells. See the Soft-Start Response in the *Typical Operating Characteristics*.

Applications Information

The MAX8640Y/MAX8640Z are optimized for use with a tiny inductor and small ceramic capacitors. The correct selection of external components ensures high efficiency, low output ripple, and fast transient response.

Inductor Selection

A 1 μ H inductor is recommended for use with the MAX8640Z, and 2.2 μ H is recommended for the MAX8640Y. A 1 μ H inductor is physically smaller but requires faster switching, resulting in some efficiency loss. Table 1 lists several recommended inductors.

It is acceptable to use a 1.5 μ H inductor with either the MAX8640Y or MAX8640Z, but efficiency and ripple should be verified. Similarly, it is acceptable to use a 3.3 μ H inductor with the MAX8640Y, but performance should be verified.

For optimum voltage positioning of load transients, choose an inductor with DC series resistance in the 75m Ω to 150m Ω range. For higher efficiency at heavy loads (above 200mA) or minimal load regulation (but some transient overshoot), the resistance should be kept as low as possible. For light-load applications up to 200mA, higher resistance is acceptable with very little impact on performance.

Capacitor Selection

Output Capacitor

The output capacitor, C2, is required to keep the output voltage ripple small and to ensure regulation loop stability. C2 must have low impedance at the switching frequency. Ceramic capacitors are recommended due to

Table 1. Suggested Inductors

MANUFACTURER	SERIES	INDUCTANCE (μ H)	DC RESISTANCE (Ω typ)	CURRENT RATING (mA)	DIMENSIONS L x W x H (mm)
FDK	MIPFT2520D	2.0	0.16	900	2.5 x 2.0 x 0.5
	MIPF2520D	1.5	0.07	1500	2.5 x 2.0 x 1.0
		2.2	0.08	1300	
		3.3	0.10	1200	
Murata	LQM31P	1.0	0.12	1200	3.2 x 1.6 x 0.95
		1.5	0.16	1000	
		2.2	0.22	900	
Sumida	CDRH2D09	1.2	0.08	590	3.0 x 3.0 x 1.0
		1.5	0.09	520	
		2.2	0.12	440	
Taiyo Yuden	CKP3216T	1.0	0.11	1100	3.2 x 1.6 x 0.9
		1.5	0.13	1000	
		2.2	0.14	900	
TDK	GLF201208T	1.0	0.15	460	2.0 x 1.25 x 0.9
		2.2	0.36	300	
	GLF2012T	1.0	0.07	400	2.0 x 1.25 x 1.35
		2.2	0.10	300	
	GLF251812T	1.0	0.10	800	2.5 x 1.8 x 1.35
		2.2	0.20	600	
TOKO	MDT2520-CR	1.0	0.05	1000	2.5 x 2.0 x 1.0
		2.2	0.08	700	
	D2812C	1.0	0.07	1100	2.8 x 2.8 x 1.2
		2.2	0.14	770	

Tiny 500mA, 4MHz/2MHz Synchronous Step-Down DC-DC Converters

their small size and low ESR. Make sure the capacitor maintains its capacitance over temperature and DC bias. Capacitors with X5R or X7R temperature characteristics typically perform well. The output capacitance can be very low; see the *Selector Guide* for recommended capacitance values. For optimum load-transient performance and very low output ripple, the output capacitor value in μF should be equal to or larger than the inductor value in μH .

Input Capacitor

The input capacitor, C1, reduces the current peaks drawn from the battery or input power source and reduces switching noise in the IC. The impedance of C1 at the switching frequency should be kept very low. Ceramic capacitors are recommended due to their small size and low ESR. Make sure the capacitor maintains its capacitance over temperature and DC bias. Capacitors with X5R or X7R temperature characteristics

Selector Guide

PART	OUTPUT VOLTAGE (V)	FREQUENCY (MHz)	RECOMMENDED COMPONENTS		TOP MARK
			L1 (μH)	C2 (μF)	
MAX8640YEXT08	0.8	1.2	2.2	10	ACQ
MAX8640YEXT10	1.0	1.6	2.2	4.7	ADF
MAX8640YEXT11	1.1	1.7	2.2	4.7	ACR
MAX8640YEXT12	1.2	1.8	2.2	4.7	ACS
MAX8640YEXT13	1.3	1.9	2.2	4.7	ACG
MAX8640YEXT15	1.5	2.0	2.2	4.7	ADD
MAX8640YEXT16	1.6	2.0	2.2	4.7	ADB
MAX8640YEXT18	1.8	2.0	2.2	4.7	ACI
MAX8640YEXT19	1.9	2.0	2.2	4.7	ACH
MAX8640YEXT24	2.4	2.0	2.2	4.7	ADM
MAX8640YEXT25	2.5	1.7	2.2	4.7	ACJ
MAX8640YEXT82	2.85	1.5	2.2	4.7	ADJ
MAX8640YELT08	0.8	1.2	2.2	10	NB
MAX8640YELT11	1.1	1.7	2.2	4.7	NC
MAX8640YELT12	1.2	1.8	2.2	4.7	ND
MAX8640YELT13	1.3	1.9	2.2	4.7	NE
MAX8640YELT15	1.5	2.0	2.2	4.7	NF
MAX8640YELT16	1.6	2.0	2.2	4.7	NG
MAX8640YELT18	1.8	2.0	2.2	4.7	NH
MAX8640YELT19	1.9	2.0	2.2	4.7	NI
MAX8640YELT25	2.5	1.7	2.2	4.7	NJ
MAX8640YELT82	2.85	1.5	2.2	4.7	OW
MAX8640ZEXT08	0.8	2.4	1	4.7	ACL
MAX8640ZEXT11	1.1	3.4	1	2.2	ACM
MAX8640ZEXT12	1.2	3.6	1	2.2	ACN
MAX8640ZEXT13	1.3	3.7	1	2.2	ACO
MAX8640ZEXT15	1.5	3.9	1	2.2	ACP
MAX8640ZEXT18	1.8	4.0	1	2.2	ACU
MAX8640ZELT08	0.8	2.4	1	4.7	NK
MAX8640ZELT11	1.1	3.4	1	2.2	NL

MAX8640Y/MAX8640Z

Tiny 500mA, 4MHz/2MHz Synchronous Step-Down DC-DC Converters

Selector Guide (continued)

PART	OUTPUT VOLTAGE (V)	FREQUENCY (MHz)	RECOMMENDED COMPONENTS		TOP MARK
			L1 (μH)	C2 (μF)	
MAX8640ZELT12	1.2	3.6	1	2.2	NM
MAX8640ZELT13	1.3	3.7	1	2.2	NN
MAX8640ZELT15	1.5	3.9	1	2.2	NO
MAX8640ZELT18	1.8	4.0	1	2.2	NP

Ordering Information (continued)

PART*	PIN-PACKAGE	TOP MARK
MAX8640YEXT24+T	6 SC70	ADM
MAX8640YEXT25+T	6 SC70	ACJ
MAX8640YELT08+T	6 μDFN	NB
MAX8640YELT11+T	6 μDFN	NC
MAX8640YELT12+T	6 μDFN	ND
MAX8640YELT13+T	6 μDFN	NE
MAX8640YELT15+T	6 μDFN	NF
MAX8640YELT16+T	6 μDFN	NG
MAX8640YELT18+T	6 μDFN	NH
MAX8640YELT19+T	6 μDFN	NI
MAX8640YELT25+T	6 μDFN	NJ
MAX8640YELT82+T	6 μDFN	OW
MAX8640ZEXT08+T	6 SC70	ACL
MAX8640ZEXT11+T	6 SC70	ACM
MAX8640ZEXT12+T	6 SC70	ACN
MAX8640ZEXT13+T	6 SC70	ACO
MAX8640ZEXT15+T	6 SC70	ACP
MAX8640ZEXT18+T	6 SC70	ACU
MAX8640ZELT08+T	6 μDFN	NK
MAX8640ZELT11+T	6 μDFN	NL
MAX8640ZELT12+T	6 μDFN	NM
MAX8640ZELT13+T	6 μDFN	NN
MAX8640ZELT15+T	6 μDFN	NO
MAX8640ZELT18+T	6 μDFN	NP

*Contact factory for availability of each version. For 2.85V output (82 version), request application note that includes limitations and typical operating characteristics.

+Denotes a lead(Pb)-free/RoHS-compliant package.

T = Tape and reel.

Note: All devices are specified over the -40°C to +85°C operating temperature range.

typically perform well. Due to the MAX8640Y/MAX8640Z soft-start, the input capacitance can be very low. For optimum noise immunity and low input ripple, choose a capacitor value in μF that is equal to or larger than the inductor's value in μH.

PCB Layout and Routing

High switching frequencies and large peak currents make PCB layout a very important part of design. Good design minimizes excessive EMI on the feedback paths and voltage gradients in the ground plane, both of which can result in instability or regulation errors. Connect the inductor, input capacitor, and output capacitor as close together as possible, and keep their traces short, direct, and wide. Connect the two GND pins under the IC and directly to the grounds of the input and output capacitors. Keep noisy traces, such as the LX node, as short as possible. Refer to the MAX8640Z evaluation kit for an example PCB layout and routing scheme.

Chip Information

PROCESS: BiCMOS

Tiny 500mA, 4MHz/2MHz Synchronous Step-Down DC-DC Converters

Package Information

For the latest package outline information and land patterns, go to www.maxim-ic.com/packages.

PACKAGE TYPE	PACKAGE CODE	DOCUMENT NO.
6 μ DFN	L611-1	21-0147
6 SC70	X6S-1	21-0077

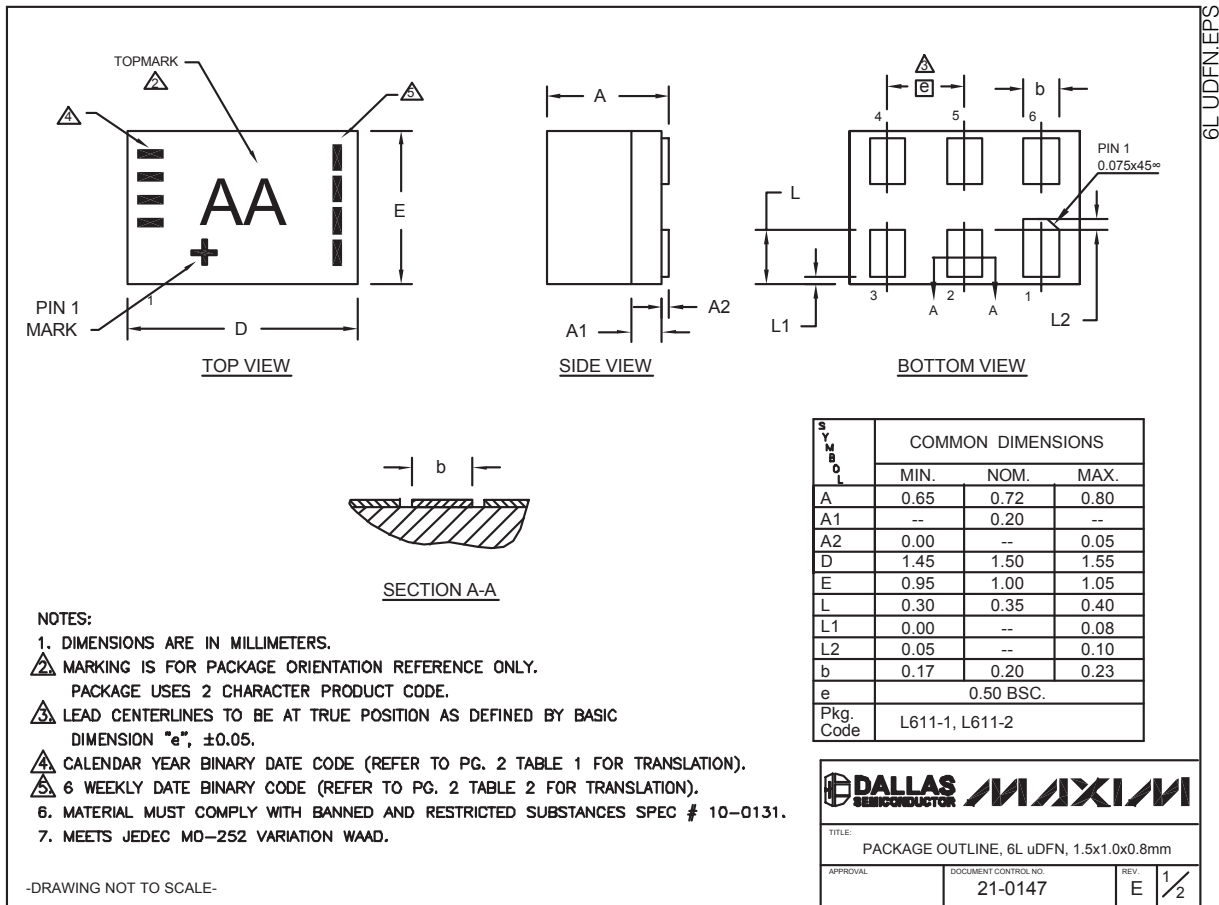

MAX8640Y/MAX8640Z

Tiny 500mA, 4MHz/2MHz Synchronous Step-Down DC-DC Converters

Package Information (continued)

For the latest package outline information and land patterns, go to www.maxim-ic.com/packages.

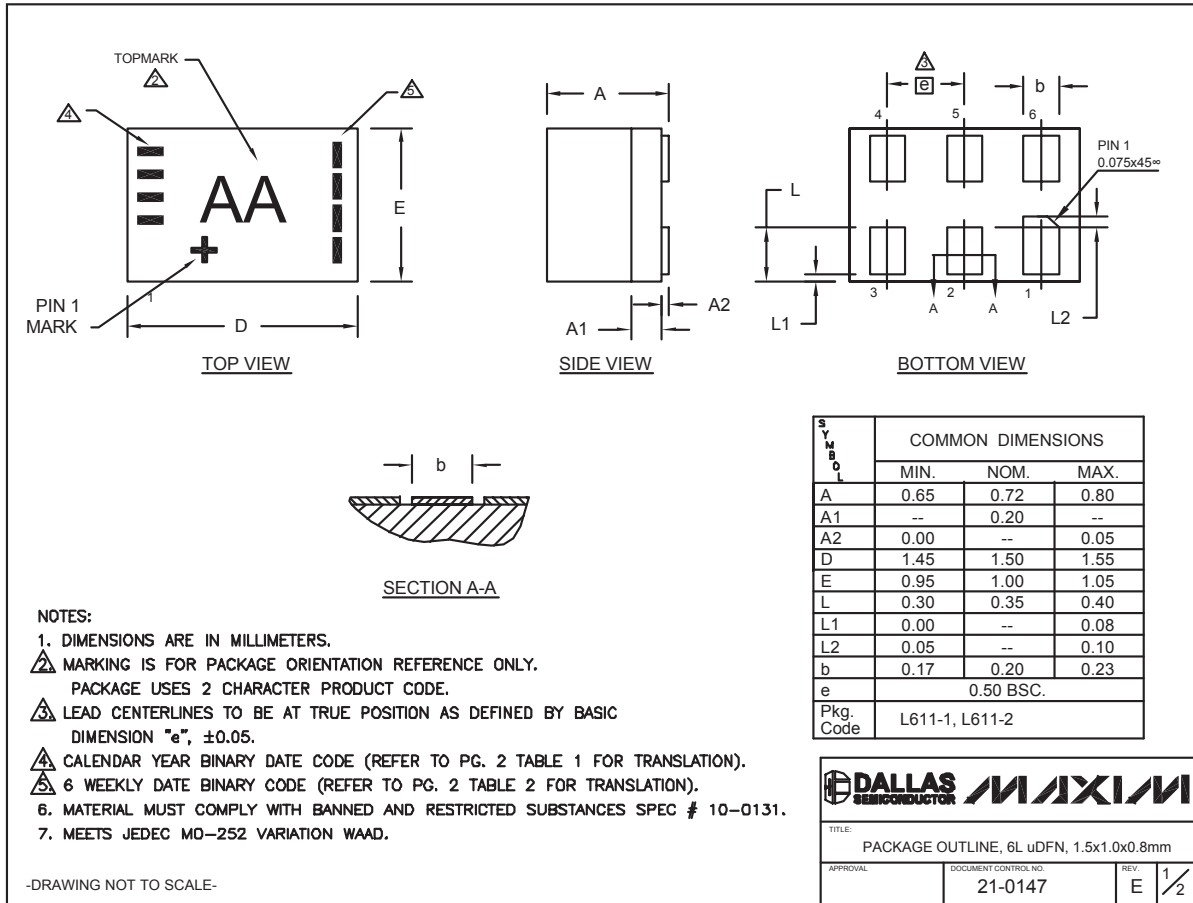

6L uDFN:EPS

Tiny 500mA, 4MHz/2MHz Synchronous Step-Down DC-DC Converters

Package Information (continued)

For the latest package outline information and land patterns, go to www.maxim-ic.com/packages.

MAX8640Y/MAX8640Z

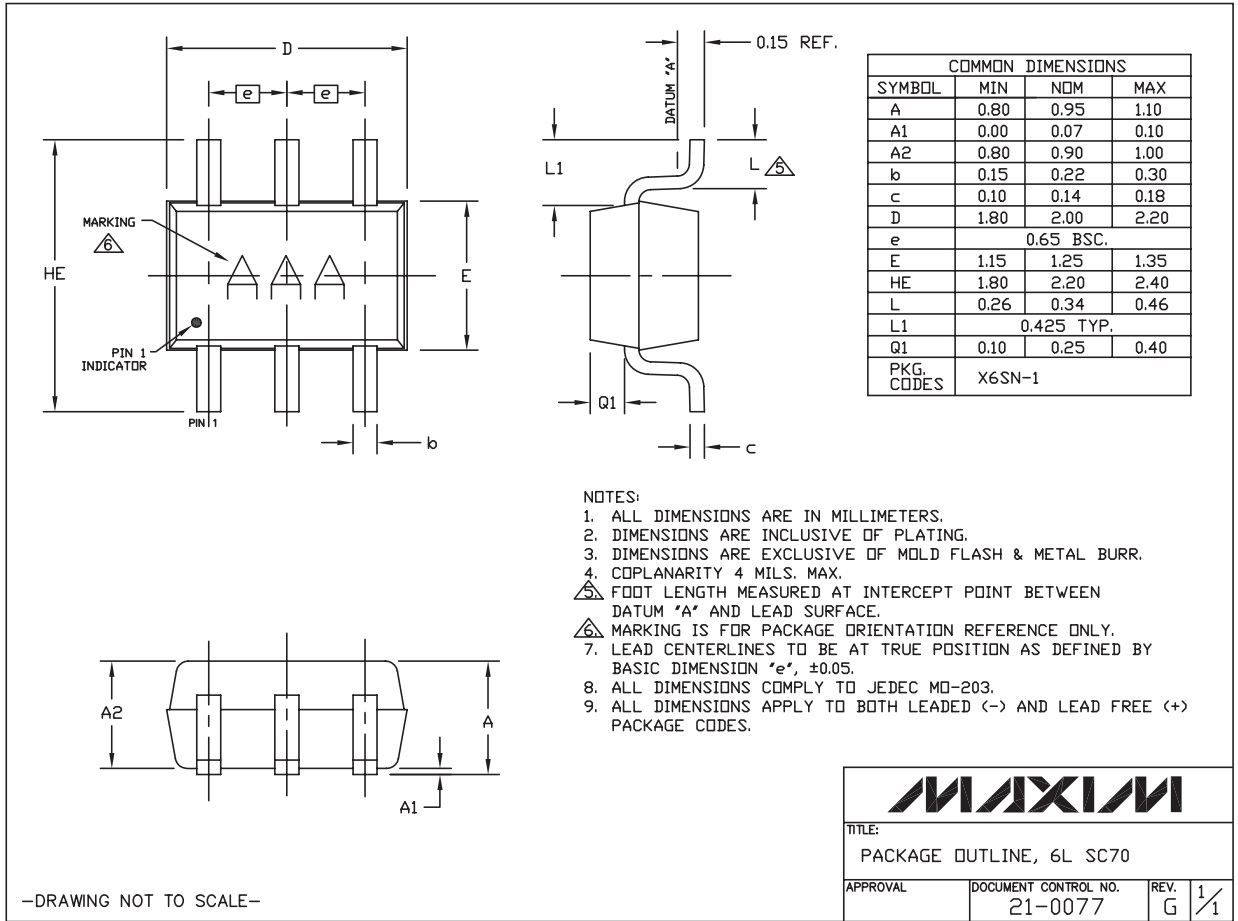

Tiny 500mA, 4MHz/2MHz Synchronous Step-Down DC-DC Converters

Revision History

REVISION NUMBER	REVISION DATE	DESCRIPTION	PAGES CHANGED
3	6/08	Added MAX8640YEXT10+T voltage option	7
4	2/09	Added MAX8640YEXT24+T voltage option and MAX8640YELT82+MAX8640YEXT82+ (82 = 2.85V), and corrected error	1, 2, 7, 8

Maxim cannot assume responsibility for use of any circuitry other than circuitry entirely embodied in a Maxim product. No circuit patent licenses are implied. Maxim reserves the right to change the circuitry and specifications without notice at any time.

12 **Maxim Integrated Products, 120 San Gabriel Drive, Sunnyvale, CA 94086 408-737-7600**