

Xinger®

Ultra Low Profile 0606 Balun 75Ω to 75Ω Balanced

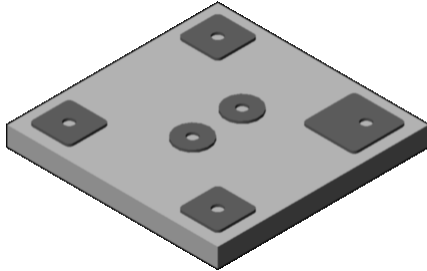

Description

The B0008K7575A00 is a low profile sub-miniature balanced to unbalanced transformer designed for differential inputs and output locations on next generation broadcast applications including tuner chipsets in an easy to use surface mount package. The B0008K7575A00 is ideal for high volume manufacturing and is higher performance than traditional wire wound baluns. The B0008K7575A00 has an unbalanced port impedance of 75Ω and a 75Ω balanced port impedance. This transformation enables single ended signals to be applied to differential ports on modern semiconductors. The output ports have equal amplitude (-3dB) with 180 degree phase differential.

Detailed Electrical Specifications: Specifications subject to change without notice.

Features:	Parameter	ROOM (25°C)			Unit
		Min.	Typ.	Max	
<ul style="list-style-type: none"> • 48 – 870 MHz • DVB-C & DVB-T • Halogen Free • 0.38 mm Height Profile • 75 Ohm to 2 x 37.5 Ohm • Broadcast Bands • Low Insertion Loss • Surface Mountable • RoHS Compliant 	Frequency	48		870	MHz
	Unbalanced Port Impedance		75		Ω
	Balanced Port Impedance		75		Ω
	Return Loss	12	14		dB
	Insertion Loss**		0.7	0.9	dB
	Amplitude Balance***		5.7	7.5	dB
	Phase Balance***		50	52	Degrees
	CMRR		5		dB
	Power Handling			1.0	Watts
	Operating Temperature		-55		+85

* Insertion Loss stated at room temperature (Insertion Loss is approximately 0.15 dB higher at +85 °C). All performances stated for recommended operation with external circuitry. **Note that Insertion Loss is calculated as the sum of powers, i.e. $10 \log[(S_{12})^2 + (S_{13})^2]$ *** Phase and amplitude balance can be improved significantly by using an external inductor as described on pages 2 - 5.

Outline Drawing

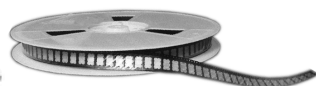
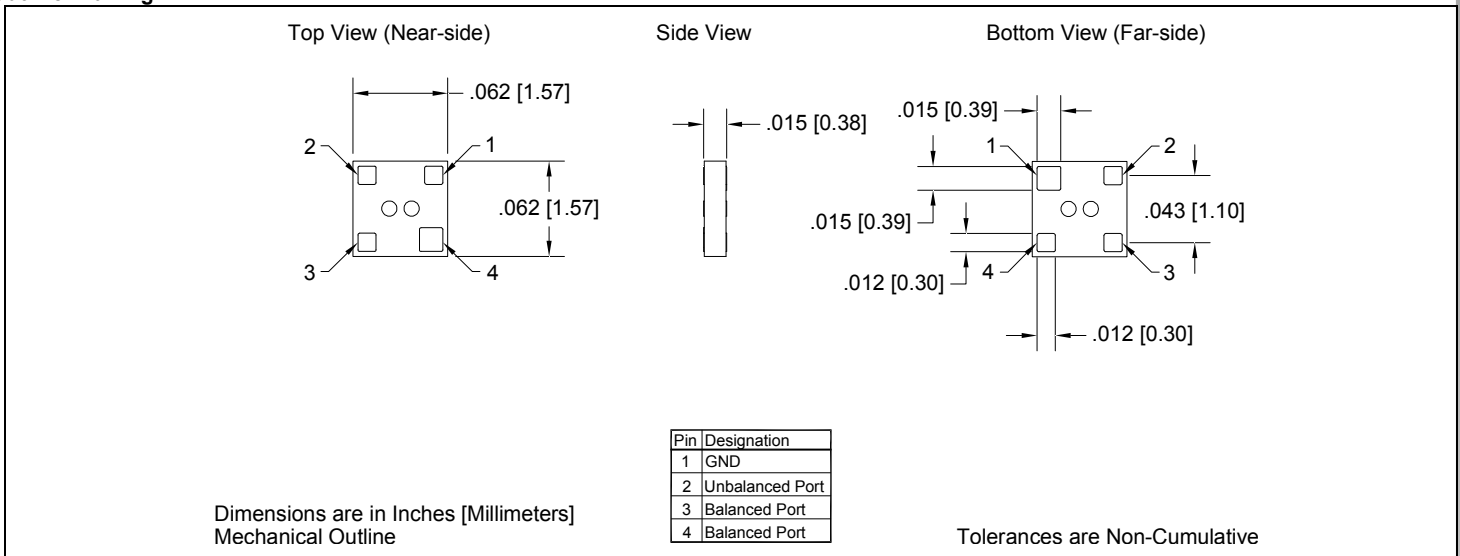

Typical Performance (test/specification condition, basic configuration)

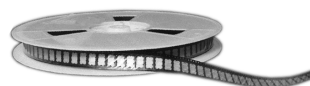
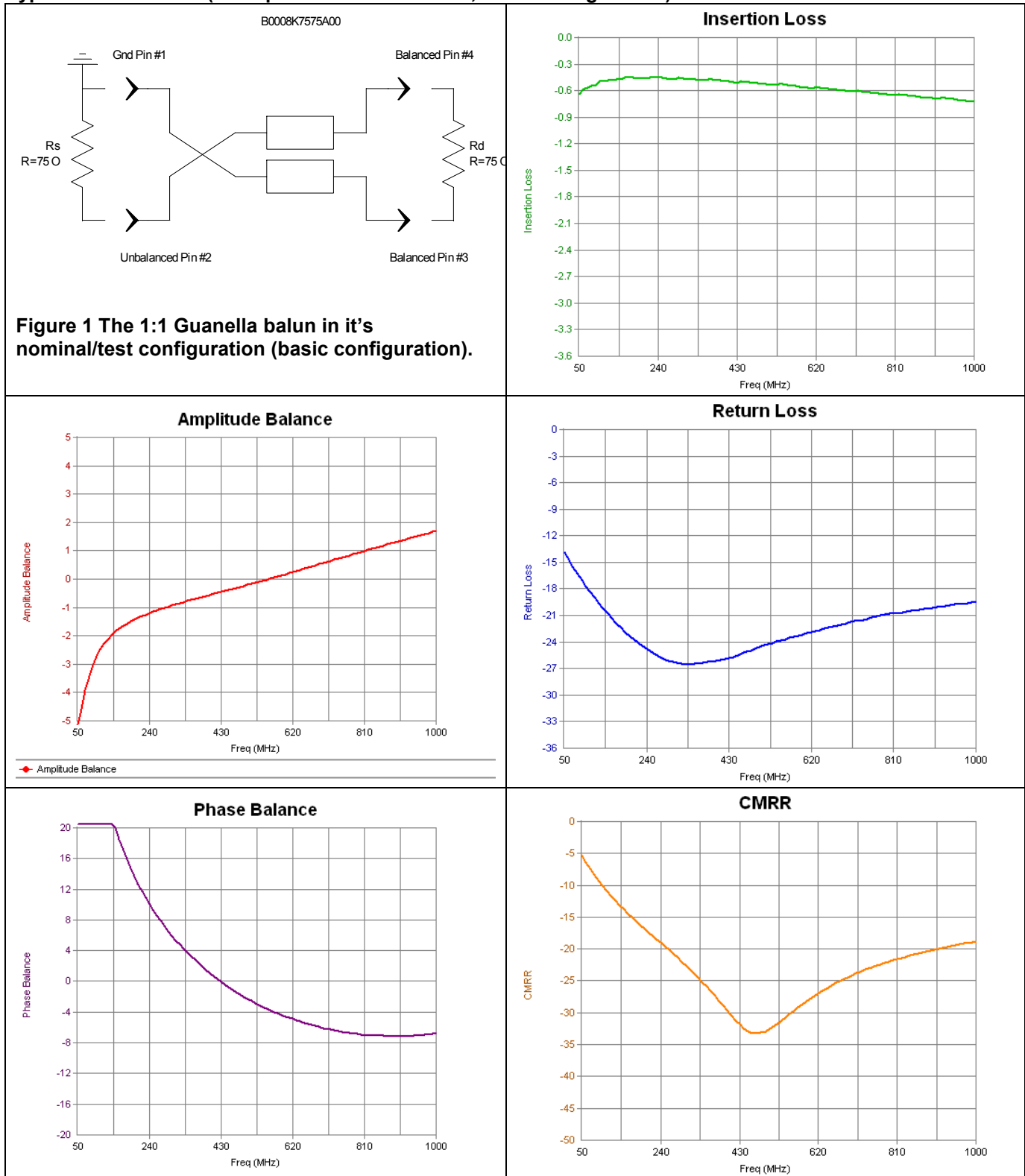

Typical Performance (Ruthroff configuration using an external 100 nH Inductor)

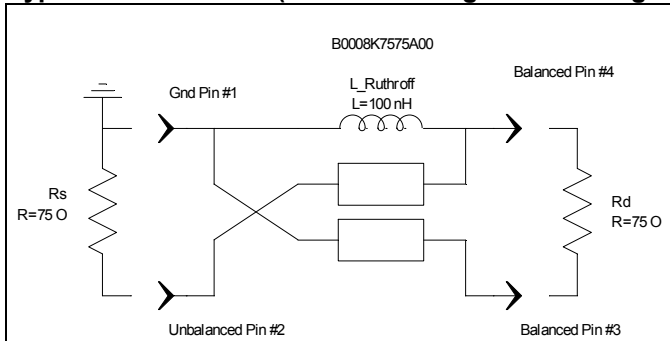
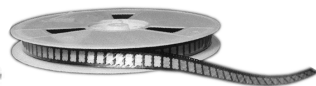
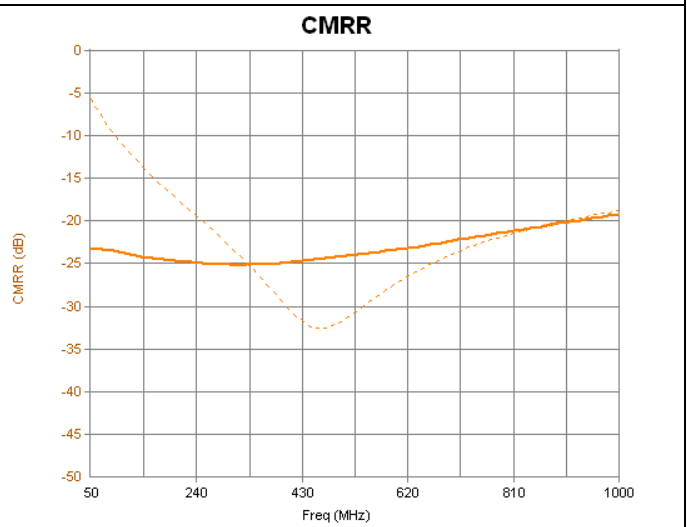
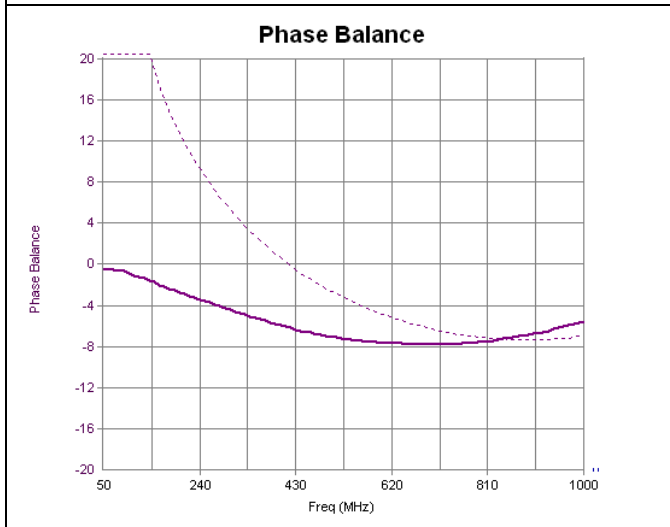
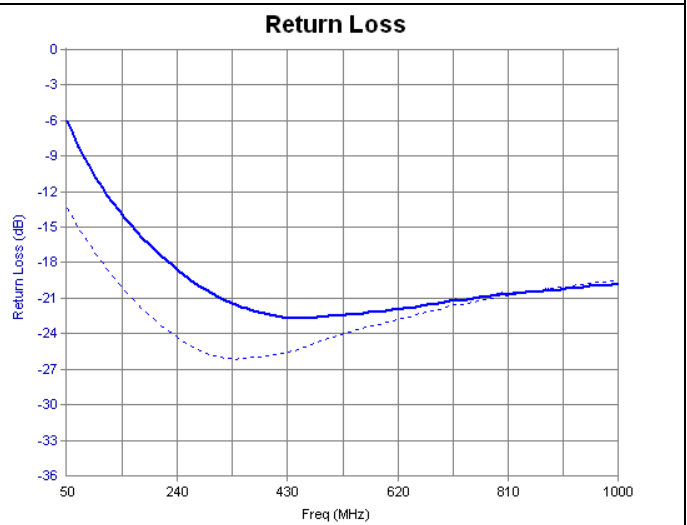
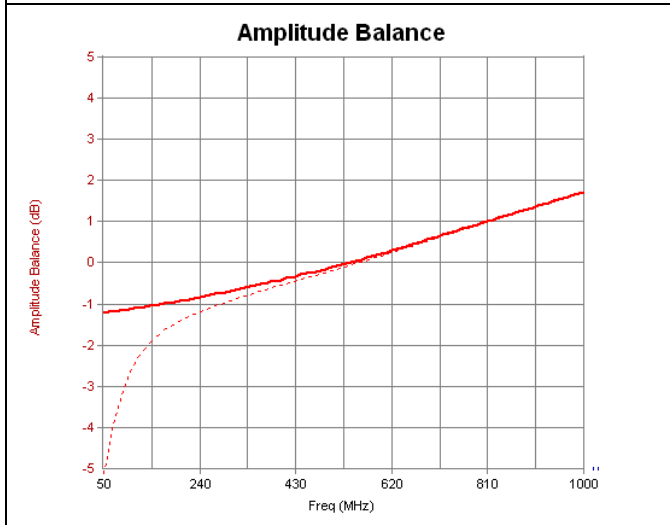
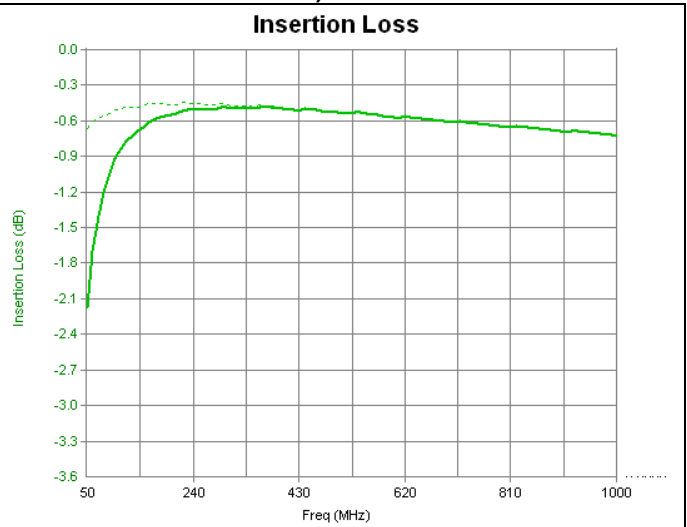

Figure 2 The Balun with an external inductor in a Ruthroff implementation with an external 100 nH inductor. Data is compared to the basic Guanella configuration (dashed lines). Other inductor values can be used with different results.



Typical Performance (using DC Block in Ruthroff configuration)

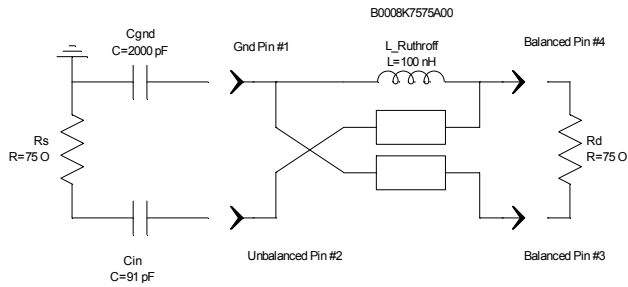
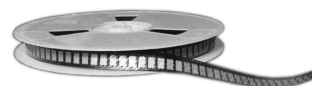
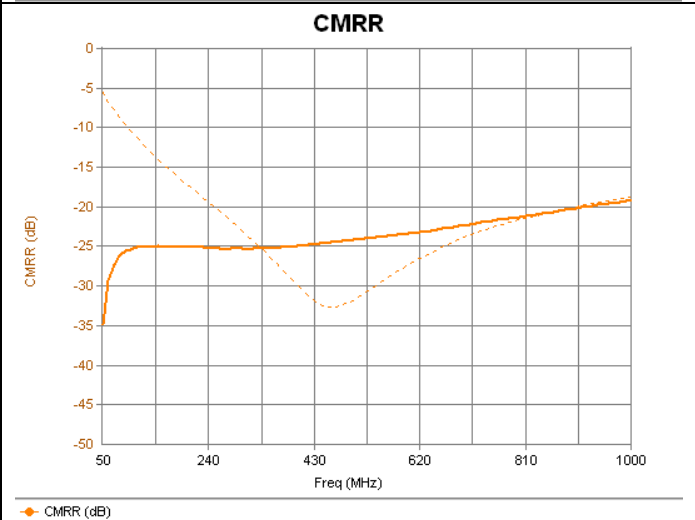
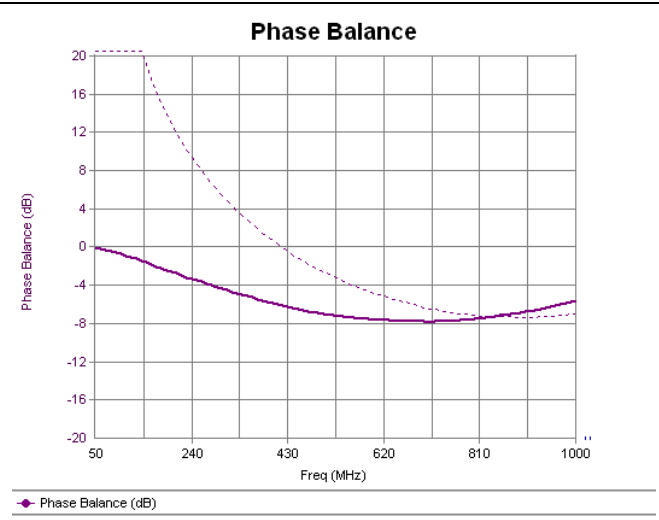
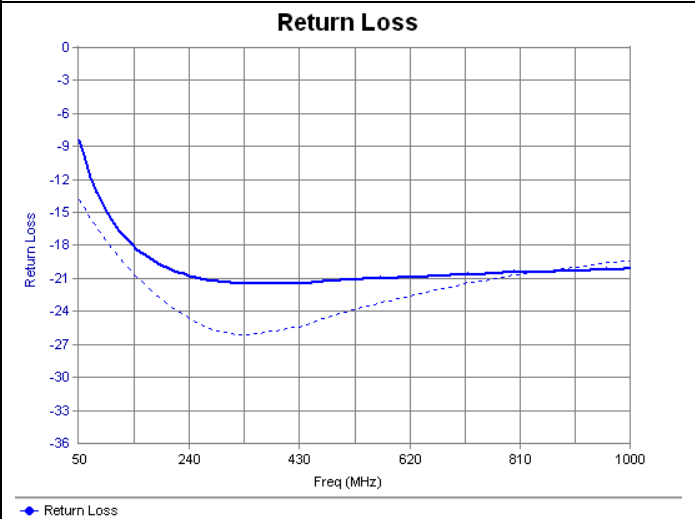
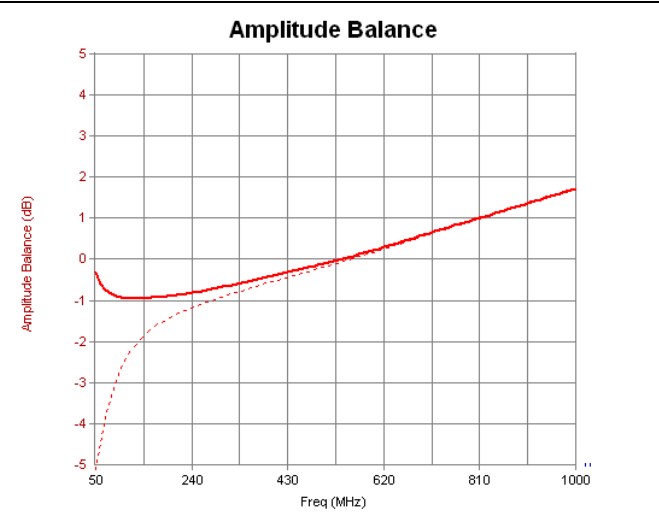
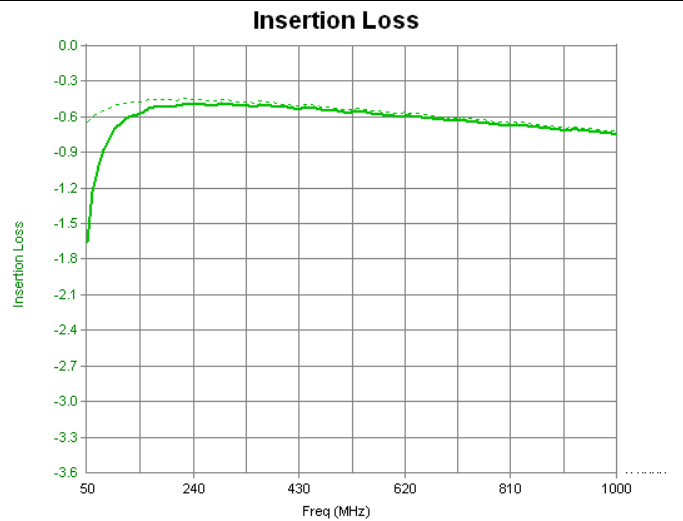

Figure 3 The Balun with an external inductor in a Ruthroff implementation with an external 100 nH inductor and DC block to enhance insertion and return loss. Data is compared to the basic Guanella configuration (dashed lines). Other capacitor and inductor values can be used with different results.



Typical Performance (using DC Block to enhance low frequency insertion and return loss)

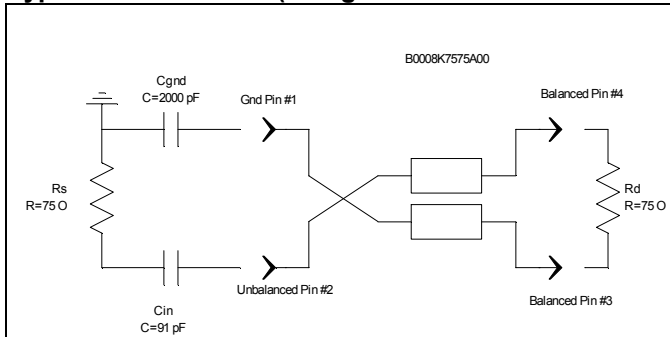
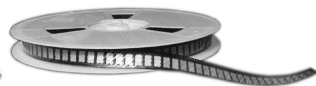
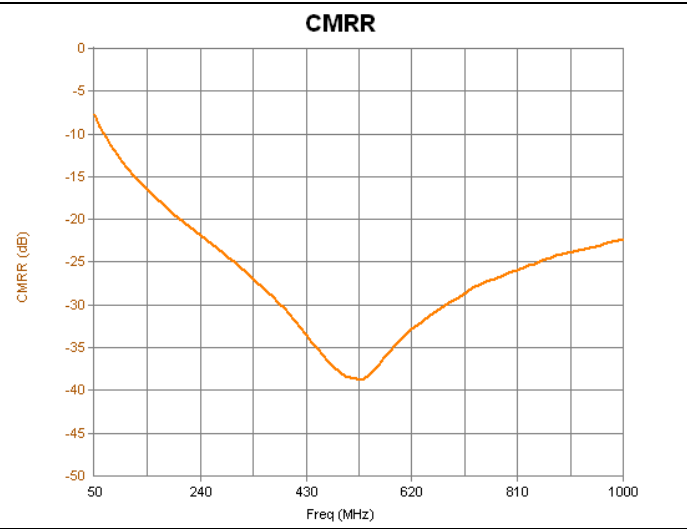
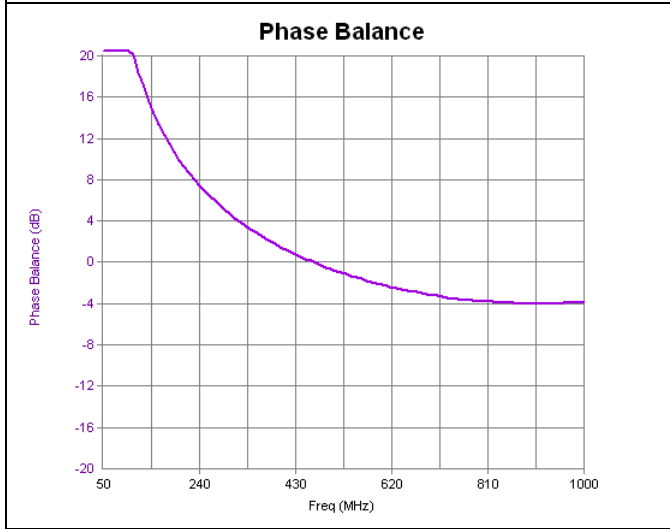
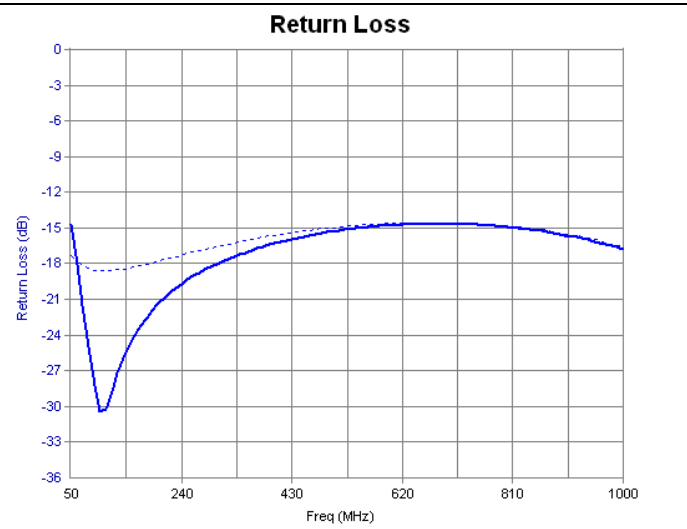
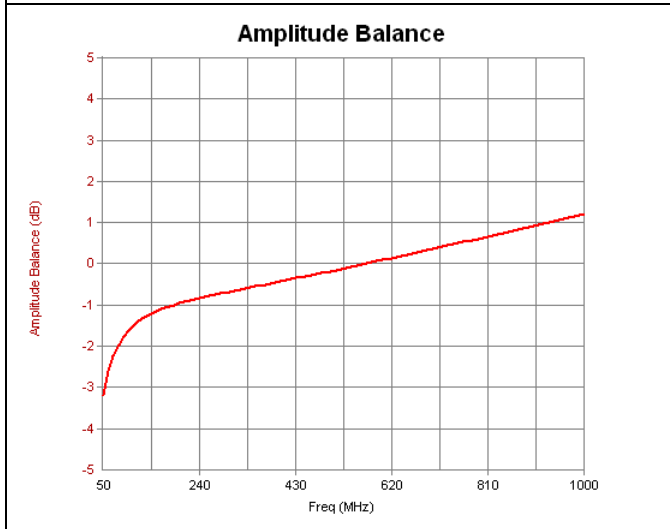

Figure 4 The Balun with an external 100 pF capacitor to enhance insertion and return loss. Data is compared to the basic Guanella configuration (dashed lines). Other capacitor values can be used with different results.



Distortion Considerations:

This balun does NOT contain any ferrite materials and are as such distortion free. Very, very low levels of distortion can arise from dissimilar metals on the contact pads of the part (Cu-Ni-Au) and from inter-metallic contaminations within the part.

Power Handling Considerations:

TBD.

USA/Canada: (315) 432-8909
Toll Free: (800) 411-6596
Europe: +44 2392-232392

Available on Tape and
Reel for Pick and Place
Manufacturing.

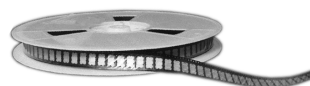

Anaren

What'll we think of next?™

Mounting Configuration:

In order for Xinger surface mount components to work optimally, the proper impedance transmission lines must be used to connect to the RF ports. If this condition is not satisfied, insertion loss, Isolation and VSWR may not meet published specifications.

All of the Xinger components are constructed from softboard composites which possess excellent electrical and mechanical stability having X and Y thermal coefficient of expansion (CTE) of 25 ppm/°C.

An example of the PCB footprint used in the testing of these parts is shown below. In specific designs, the transmission line widths need to be adjusted to the unique dielectric coefficients and thicknesses as well as varying pick and place equipment tolerances.

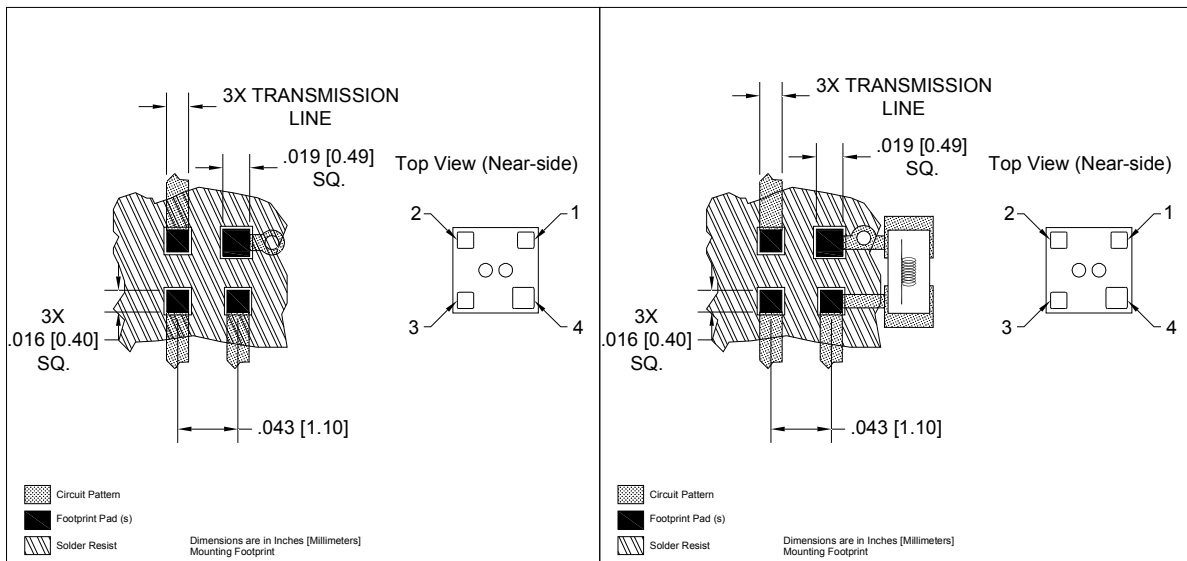

The material used for testing is 8mil Rogers 4003. For a ground plane spacing much larger than this the single via at pin 5 should be replaced with at least 2 via and if possible a coplanar ground.

