



PRODUCT SPECIFICATION

Model No : CSPR-N32DSW4-A0R

Descriptions:	
■ LED Type	: Superbright Lamp
■ LED Package	: Piranha LED Lamp
■ Emitting Color	: White
■ Viewing Angle	: 90°
■ Stopper	



CUSTOMER APPROVED SIGNATURES	APPROVED BY	CHECKED BY	PREPARED BY

CHINA SEMICONDUCTOR CORPORATION
 Address:2FL. NO.909,Chung-Cheng Road,
 Chung-Ho City Taipei Hsien,Taiwan.

Tel:886-2-2223-9696
 Fax:886-2-2223-9377

OPTO PLUS TECHNOLOGIES CO.,LTD
 Address:696 Shun jiang Rd.,Ji Shan St.Shaoxing,
 ZheJiang,China

Tel:86-0575-88623888
 Fax:86-0575-88623112



Model No : CSPR-N32DSW4-A0R

Features -

1. High Current Operation
2. High Luminous Output
3. High Reliability and Solid Performance
4. Optimal Optical/Mechanical Design
5. Packaged in Tubes for Use with Automatic Pick and Place Equipment
6. Rohs Compliant

Device Selection Guide -

Part No.	Chip		LED Lens
	Material	Emitted Color	
CSPR-N32DSW4-A0R	InGaN	Blue	Water Transparent

Package Outline Dimensions -

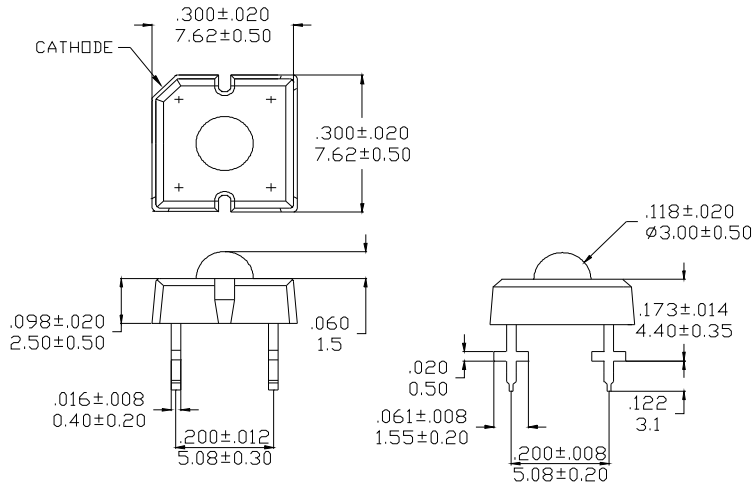

* Tolerance : $\pm \frac{0.01}{0.25}$ Unit : $\pm \frac{\text{inch}}{\text{mm}}$



Model No : CSPR-N32DSW4-A0R

■ Absolute Maximum Rating -

(Ta=25°C)

Parameter	Symbol	Rating	Unit
Power Dissipation	Pd	190	mW
Forward Current (DC)	IF	50	mA
Peak Forward Current *	IFP	100	mA
Reverse Voltage	VR	5	V
Operating Temp.	Topr	-30 ~ +80	°C
Storage Temp.	Tstg	-40 ~ +100	°C
Lead Soldering Temperature	Tsol	Max. 260°C for 5 sec Max. (3mm from the epoxy bulb)	

* Pulse width ≤ 0.1 msec. duty $\leq 1/10$

■ Electro-optical Characteristics -

(Ta=25°C)

Parameter	Symbol	Min.	Typ.	Max.	Unit	Condition
Forward Voltage	VF	-----	3.3	3.8	V	IF=50mA
Luminous Intensity	Iv	1800	3500	-----	mcd	
Luminous Flux	Φv	600	2200	-----	mlm	
Chromaticity	X	-----	0.30	-----	-----	
Coordination	Y	-----	0.31	-----	-----	
Viewing Angle	2θ 1/2	-----	90	-----	deg	
Reverse Current	IR	-----	-----	100	μ A	VR=5V



■ Luminous Flux Rank Limits ($I_f = 50\text{mA}$)

unit : mlm

Part No Code	CSPR-N32DSW4-A0R	
	min.	max.
A	600	1000
B	1000	1500
C	1500	2000
D	2000	2500
E	2500	3000

■ Dominant Wavelength Rank Limits ($I_f = 50\text{mA}$)

Rank a				
X	0.280	0.264	0.283	0.296
Y	0.248	0.267	0.305	0.276
Color Temperature:6500~10000K				
Rank b1				
X	0.287	0.283	0.330	0.330
Y	0.295	0.305	0.360	0.339
Color Temperature:5500~6500K				
Rank b2				
X	0.296	0.287	0.330	0.330
Y	0.276	0.295	0.339	0.318
Color Temperature:5500~6500K				
Rank c				
X	0.330	0.330	0.361	0.356
Y	0.318	0.360	0.385	0.351
Color Temperature:4500~5500K				

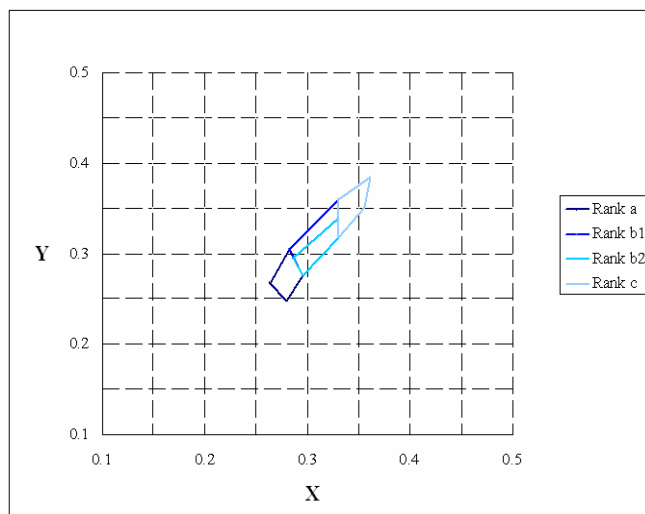

■ Forward Voltage Rank Limits ($I_f = 50\text{mA}$)

Part No Code	CSPR-N32DSW4-A0R	
	min.	max.
H	2.8	3.0
J	3.0	3.2
K	3.2	3.4
L	3.4	3.6
M	3.6	3.8

Notes:

1. Tolerance of measurement of luminous Flux :±15%
2. Tolerance of measurement of dominant wavelength :±2nm
3. Tolerance of measurement of forward voltage :±0.05v
4. All data are measured by CSC's test equipment.
5. One delivery will include several color rank, VF rank and I_v ranks of the products.
6. The quantity-ratio of the ranks is decided by CSC.
7. Please confirm with CSC salesman, if your request different from standard specification.



Model No : CSPR-N32DSW4-A0R

■ Typical Electrical / Optical Characteristics Curves -

(Ta = 25°C Unless Otherwise Noted)

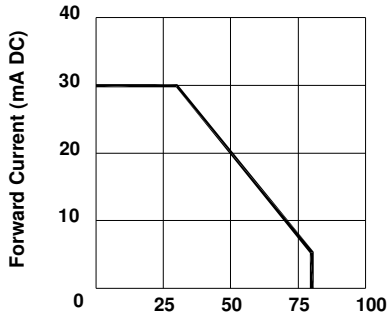

Ambient Temperature Ta (°C)
Fig 1. Forward Current
Vs. Ambient Temperature

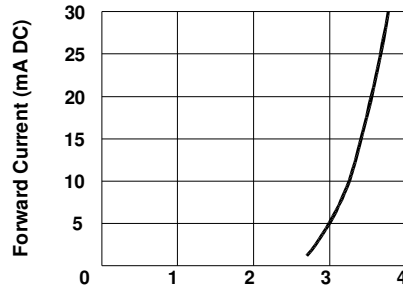

Forward Voltage VF (V)
Fig 2. Forward Current
Vs. Forward Voltage



Forward Current IF (mA DC)
Fig 3. Relative Intensity
Vs. Forward Current

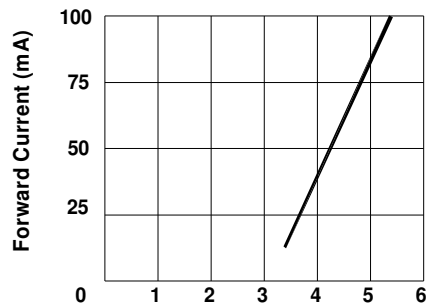

Forward Voltage (V)
Fig 4. Peak Forward Voltage
Vs. Forward Current
(100us test pulse, 1% duty cycle)

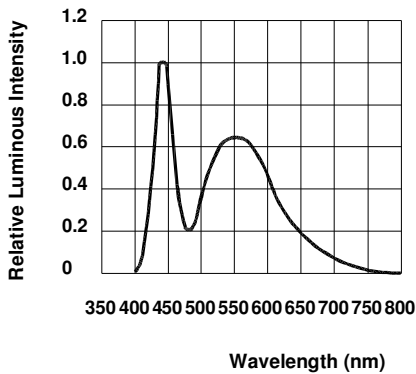

Fig 5. Relative Intensity Vs. Wavelength

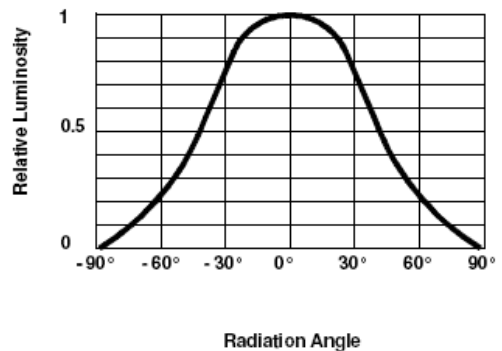

Fig 6. Relative Luminous Intensity vs. Radiation Angle



Model No : CSPR-N32DSW4-A0R

■ Precautions For Use -

1. Recommended Soldering conditions

Wave Soldering

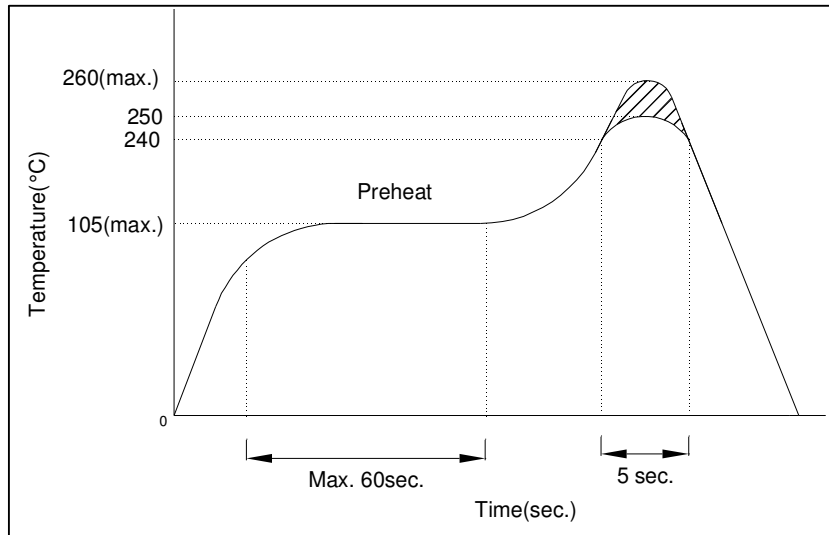

2. Soldering Iron

Basic SPEC. is $\leq 5\text{sec.}$ When 260°C . If temperature is higher, time should be shorter ($+10^{\circ}\text{C} \rightarrow -1\text{sec.}$). Power dissipation of iron should be smaller than 15W, and temperature should be controllable. Surface temperature of the device should be under 230°C .

3. Static Electricity

- Static electricity or surge voltage damages LEDs..

It is recommended that a wrist band or an anti-electrostatic glove be used when handling the LEDs.

- All devices, equipment and machinery must be properly grounded. It is recommended that measures be taken against surge voltage to the equipment that mounts the LEDs.

Note: The specifications are subject to change without notice. Please contact us for updated information.