

FEATURES

Ultralow noise

0.9 nV/ $\sqrt{\text{Hz}}$

2.4 pA/ $\sqrt{\text{Hz}}$

1.2 nV/ $\sqrt{\text{Hz}}$ @10 Hz

Ultralow distortion: -93 dBc at 500 kHz

Wide supply voltage range: ± 5 V to ± 16 V

High speed

-3 dB bandwidth: 65 MHz (G = +1)

Slew rate: 55 V/ μs

Unity gain stable

Low input offset voltage: 150 μV maximum

Low input offset voltage drift: 1 $\mu\text{V}/^\circ\text{C}$

Low input bias current: -0.1 μA

Low input bias current drift: 2 nA/ $^\circ\text{C}$

Supply current: 8 mA

Power-down feature

APPLICATIONS

Instrumentation

Active filters

DAC buffers

SAR ADC drivers

Optoelectronics

GENERAL DESCRIPTION

The ADA4898-1 is an ultralow noise and distortion, unity gain stable, voltage feedback op amp that is ideal for use in 16-bit and 18-bit systems with power supplies from ± 5 V to ± 16 V. The ADA4898-1 features a linear, low noise input stage and internal compensation that achieves high slew rates and low noise.

With the wide supply voltage range, low offset voltage, and wide bandwidth, the ADA4898-1 is designed to work in the most demanding applications. The ADA4898-1 also features an input bias current cancellation mode that reduces input bias current by a factor of 60.

The ADA4898-1 is available in an 8-lead SOIC package that features an exposed metal paddle on its underside that improves heat transfer to the ground plane. This is a significant improvement over traditional plastic packages. The ADA4898-1 is rated to work over the extended automotive temperature range of -40°C to $+105^\circ\text{C}$.

CONNECTION DIAGRAM

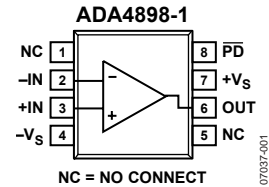

Figure 1. 8-Lead SOIC_N_EP (RD-8)

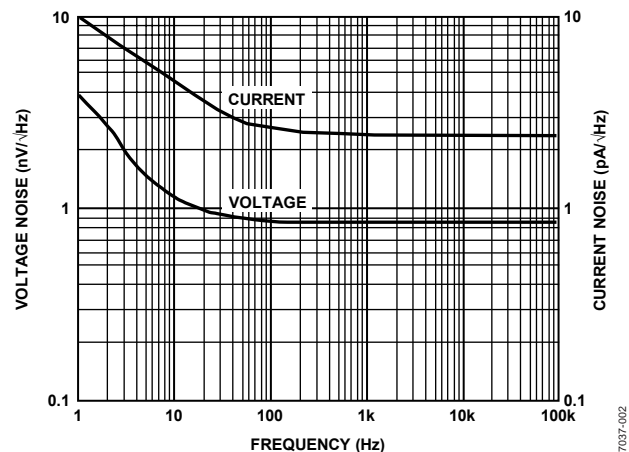

Figure 2. Input Voltage Noise and Current Noise vs. Frequency

Rev. 0

Information furnished by Analog Devices is believed to be accurate and reliable. However, no responsibility is assumed by Analog Devices for its use, nor for any infringements of patents or other rights of third parties that may result from its use. Specifications subject to change without notice. No license is granted by implication or otherwise under any patent or patent rights of Analog Devices. Trademarks and registered trademarks are the property of their respective owners.

TABLE OF CONTENTS

Features	1	Theory of Operation	13
Applications.....	1	$\overline{\text{PD}}$ (Power Down) Pin.....	13
Connection Diagram	1	Current Noise Measurement	13
General Description.....	1	Applications Information.....	14
Revision History	2	Higher Feedback Gain Operation.....	14
Specifications with ± 15 V Supply.....	3	Recommended Values for Various Gains.....	14
Specifications with ± 5 V Supply.....	4	Noise	15
Absolute Maximum Ratings.....	5	Circuit Considerations	15
Thermal Resistance	5	PCB Layout	15
Maximum Power Dissipation	5	Power Supply Bypassing.....	15
ESD Caution.....	5	Grounding.....	15
Pin Configuration and Function Descriptions.....	6	Outline Dimensions	16
Typical Performance Characteristics	7	Ordering Guide	16
Test Circuits.....	12		

REVISION HISTORY

5/08—Revision 0: Initial Release

SPECIFICATIONS WITH ± 15 V SUPPLY

$T_A = 25^\circ\text{C}$, $G = +1$, $R_F = 0 \Omega$, R_G open, $R_L = 1 \text{ k}\Omega$ to GND (for $G > 1$, $R_F = 100 \Omega$), unless otherwise noted.

Table 1.

Parameter	Conditions	Min	Typ	Max	Unit
DYNAMIC PERFORMANCE					
-3 dB Bandwidth	$V_{OUT} = 100 \text{ mV p-p}$		65		MHz
	$V_{OUT} = 2 \text{ V p-p}$		14		MHz
Bandwidth for 0.1 dB Flatness	$G = +2$, $V_{OUT} = 2 \text{ V p-p}$		3.3		MHz
Slew Rate	$V_{OUT} = 5 \text{ V step}$		55		V/ μs
Settling Time to 0.1%	$V_{OUT} = 5 \text{ V step}$		85		ns
NOISE/DISTORTION PERFORMANCE					
Harmonic Distortion SFDR	$f = 100 \text{ kHz}$, $V_{OUT} = 2 \text{ V p-p}$		-116		dBc
	$f = 500 \text{ kHz}$, $V_{OUT} = 2 \text{ V p-p}$		-93		dBc
	$f = 1 \text{ MHz}$, $V_{OUT} = 2 \text{ V p-p}$		-79		dBc
Input Voltage Noise	$f = 100 \text{ kHz}$		0.9		nV/ $\sqrt{\text{Hz}}$
Input Current Noise	$f = 100 \text{ kHz}$		2.4		pA/ $\sqrt{\text{Hz}}$
DC PERFORMANCE					
Input Offset Voltage			20	110	μV
Input Offset Voltage Drift			1		$\mu\text{V}/^\circ\text{C}$
Input Bias Current			-0.1	-0.4	μA
Input Bias Offset Current			0.03	0.3	μA
Input Bias Current Drift			2		nA/ $^\circ\text{C}$
Open-Loop Gain	$V_{OUT} = \pm 5 \text{ V}$	99	103		dB
INPUT CHARACTERISTICS					
Input Resistance	Differential mode		5		k Ω
	Common mode		30		M Ω
Input Capacitance	Differential mode		0.8		pF
	Common mode		2.2		pF
Input Common-Mode Voltage Range			± 11		V
Common-Mode Rejection Ratio	$V_{CM} = \pm 2 \text{ V}$	-103	-126		dB
PD (Power Down) PIN					
$\overline{\text{PD}}$ Input Voltages	Chip powered down		≤ -14		V
	Chip enabled		≥ -13		V
Input Leakage Current	$\overline{\text{PD}} = +V_S$		-0.1		μA
	$\overline{\text{PD}} = -V_S$		-0.2		μA
OUTPUT CHARACTERISTICS					
Output Voltage Swing	$R_L = 1 \text{ k}\Omega$	-11.4 to +12.1	-11.7 to +12.2		V
	$R_L = \text{None}$	± 12.76	± 12.82		V
Short-Circuit Current	Sinking/sourcing		150		mA
Off Isolation	$f = 1 \text{ MHz}$, $\overline{\text{PD}} = -V_S$		80		dB
POWER SUPPLY					
Operating Range		± 4.5		± 16.5	V
Quiescent Current	$\overline{\text{PD}} = +V_S$		8.1		mA
	$\overline{\text{PD}} = -V_S$		0.1		mA
Positive Power Supply Rejection Ratio	$+V_S = 15 \text{ V to } 17 \text{ V}$, $-V_S = -15 \text{ V}$	-98	-107		dB
Negative Power Supply Rejection Ratio	$+V_S = 15 \text{ V}$, $-V_S = -15 \text{ V to } -17 \text{ V}$	-100	-114		dB

ADA4898-1

SPECIFICATIONS WITH ± 5 V SUPPLY

$T_A = 25^\circ\text{C}$, $G = +1$, $R_F = 0 \Omega$, R_G open, $R_L = 1 \text{ k}\Omega$ to GND (for $G > 1$, $R_F = 100 \Omega$), unless otherwise noted.

Table 2.

Parameter	Conditions	Min	Typ	Max	Unit
DYNAMIC PERFORMANCE					
-3 dB Bandwidth	$V_{OUT} = 100 \text{ mV p-p}$		57		MHz
	$V_{OUT} = 2 \text{ V p-p}$		12		MHz
Bandwidth for 0.1 dB Flatness	$G = +2$, $V_{OUT} = 2 \text{ V p-p}$		3		MHz
Slew Rate	$V_{OUT} = 2 \text{ V step}$		50		V/ μs
Settling Time to 0.1%	$V_{OUT} = 2 \text{ V step}$		90		ns
NOISE/DISTORTION PERFORMANCE					
Harmonic Distortion SFDR	$f = 500 \text{ kHz}$, $V_{OUT} = 2 \text{ V p-p}$		-95		dBc
	$f = 1 \text{ MHz}$, $V_{OUT} = 2 \text{ V p-p}$		-78		dBc
Input Voltage Noise	$f = 100 \text{ kHz}$		0.9		nV/ $\sqrt{\text{Hz}}$
Input Current Noise	$f = 100 \text{ kHz}$		2.4		pA/ $\sqrt{\text{Hz}}$
DC PERFORMANCE					
Input Offset Voltage			30	150	μV
Input Offset Voltage Drift			1		$\mu\text{V}/^\circ\text{C}$
Input Bias Current			-0.1	-0.4	μA
Input Bias Offset Current			0.01	0.3	μA
Input Bias Current Drift			2		nA/ $^\circ\text{C}$
Open-Loop Gain	$V_{OUT} = \pm 1 \text{ V}$	90	94		dB
INPUT CHARACTERISTICS					
Input Resistance	Differential mode		5		k Ω
	Common mode		30		M Ω
Input Capacitance	Differential mode		0.8		pF
	Common mode		2.2		pF
Input Common-Mode Voltage Range			-3 to +2.5		V
Common-Mode Rejection Ratio	$V_{CM} = \pm 1 \text{ V}$	-102	-120		dB
PD (Power Down) PIN					
PD Input Voltages	Chip powered down		≤ -4		V
	Chip enabled		≥ -3		V
Input Leakage Current	$\overline{\text{PD}} = +V_S$		0.1		μA
	$\overline{\text{PD}} = -V_S$		-2		μA
OUTPUT CHARACTERISTICS					
Output Voltage Swing	$R_L = 1 \text{ k}\Omega$	± 3.12	± 3.17		V
	$R_L = \text{None}$	± 3.3	± 3.34		V
Short-Circuit Current	Sinking/sourcing		150		mA
Off Isolation	$f = 1 \text{ MHz}$, $\overline{\text{PD}} = -V_S$		80		dB
POWER SUPPLY					
Operating Range		± 4.5		± 16.5	V
Quiescent Current	$\overline{\text{PD}} = +V_S$		7.7		mA
	$\overline{\text{PD}} = -V_S$		0.1		mA
Positive Power Supply Rejection Ratio	$+V_S = 5 \text{ V to } 7 \text{ V}$, $-V_S = -5 \text{ V}$	-95	-100		dB
Negative Power Supply Rejection Ratio	$+V_S = 5 \text{ V}$, $-V_S = -5 \text{ V to } -7 \text{ V}$	-97	-104		dB

ABSOLUTE MAXIMUM RATINGS

Table 3.

Parameter	Rating
Supply Voltage	36 V
Power Dissipation	See Figure 3
Differential Mode Input Voltage	±1.5 V
Common-Mode Input Voltage	±11.4 V
Storage Temperature Range	−65°C to +150°C
Operating Temperature Range	−40°C to +105°C
Lead Temperature (Soldering, 10 sec)	300°C
Junction Temperature	150°C

Stresses above those listed under Absolute Maximum Ratings may cause permanent damage to the device. This is a stress rating only; functional operation of the device at these or any other conditions above those indicated in the operational section of this specification is not implied. Exposure to absolute maximum rating conditions for extended periods may affect device reliability.

THERMAL RESISTANCE

θ_{JA} is specified for the worst-case conditions, that is, θ_{JA} is specified for a device soldered in the circuit board with its exposed paddle soldered to a pad on the PCB surface that is thermally connected to a copper plane, with zero airflow.

Table 4.

Package Type	θ_{JA}	θ_{JC}	Unit
8-Lead SOIC with EP on Four-Layer Board	47	29	°C/W

MAXIMUM POWER DISSIPATION

The maximum safe power dissipation in the ADA4898-1 package is limited by the associated rise in junction temperature (T_J) on the die. At approximately 150°C, which is the glass transition temperature, the plastic changes its properties. Even temporarily exceeding this temperature limit can change the stresses that the package exerts on the die, permanently shifting the parametric performance of the ADA4898-1. Exceeding a junction temperature of 150°C for an extended period can result in changes in the silicon devices, potentially causing failure.

The power dissipated in the package (P_D) is the sum of the quiescent power dissipation and the power dissipated in the package due to the output load drive. The quiescent power is the voltage between the supply pins (V_S) times the quiescent current (I_S). The power dissipated due to the load drive depends upon the particular application. For each output, the power due to load drive is calculated by multiplying the load current by the associated voltage drop across the device. RMS voltages and currents must be used in these calculations.

Airflow increases heat dissipation, effectively reducing θ_{JA} . In addition, more metal directly in contact with the package leads from metal traces, through holes, ground, and power planes reduces the θ_{JA} . The exposed paddle on the underside of the package must be soldered to a pad on the PCB surface that is thermally connected to a copper plane to achieve the specified θ_{JA} .

Figure 3 shows the maximum safe power dissipation in the package vs. the ambient temperature for the 8-lead SOIC_EP (47°C/W) on a JEDEC standard four-layer board, with its underside paddle soldered to a pad that is thermally connected to a PCB plane. θ_{JA} values are approximations.

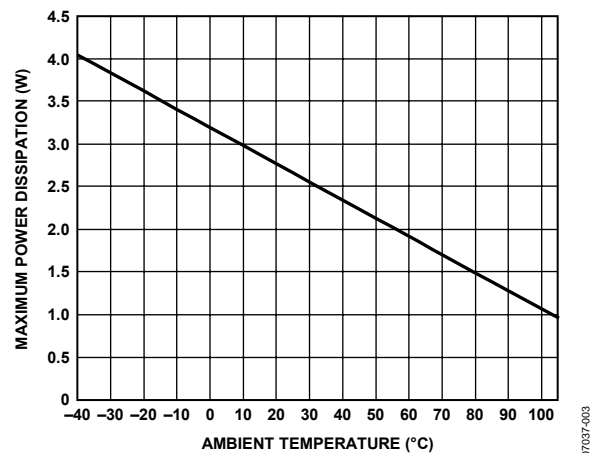

Figure 3. Maximum Power Dissipation vs. Ambient Temperature

ESD CAUTION



ESD (electrostatic discharge) sensitive device. Charged devices and circuit boards can discharge without detection. Although this product features patented or proprietary protection circuitry, damage may occur on devices subjected to high energy ESD. Therefore, proper ESD precautions should be taken to avoid performance degradation or loss of functionality.

ADA4898-1

PIN CONFIGURATION AND FUNCTION DESCRIPTIONS

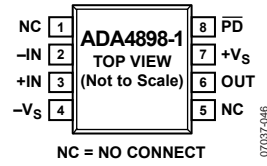

Figure 4. Pin Configuration

Table 5. Pin Function Descriptions

Pin No.	Mnemonic	Description
1	NC	No Connect
2	-IN	Inverting Input
3	+IN	Noninverting Input
4	-Vs	Negative Supply
5	NC	No Connect
6	OUT	Output
7	+Vs	Positive Supply
8	$\overline{\text{PD}}$	Power Down

TYPICAL PERFORMANCE CHARACTERISTICS

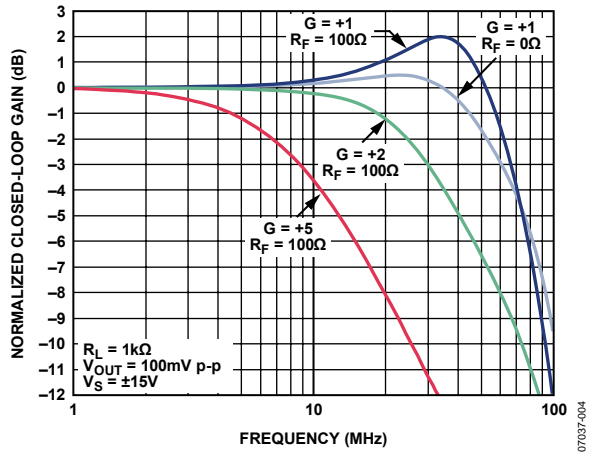

Figure 5. Small Signal Frequency Response for Various Gains

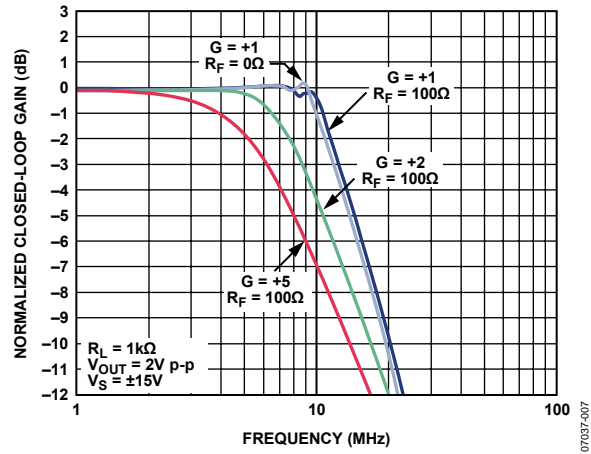

Figure 8. Large Signal Frequency Response for Various Gains

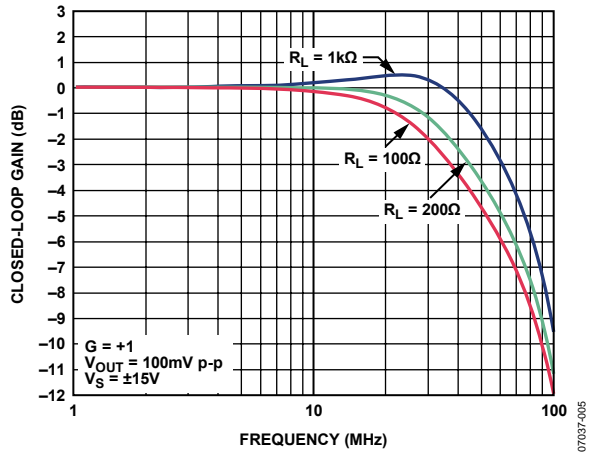

Figure 6. Small Signal Frequency Response for Various Loads

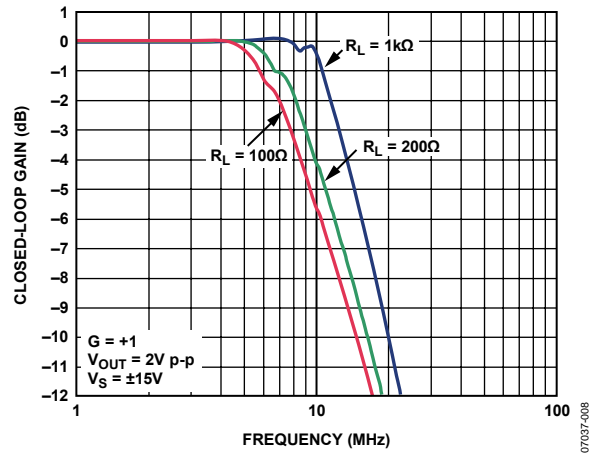

Figure 9. Large Signal Frequency Response for Various Loads

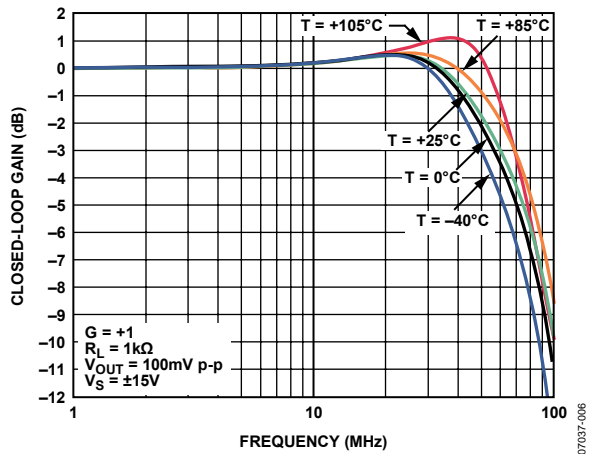

Figure 7. Small Signal Frequency Response for Various Temperatures

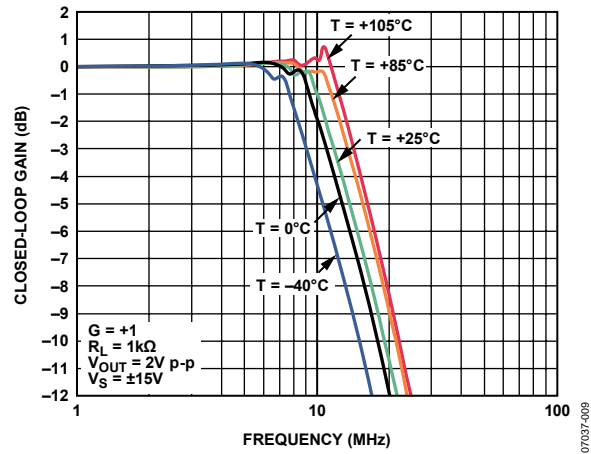

Figure 10. Large Signal Frequency Response for Various Temperatures

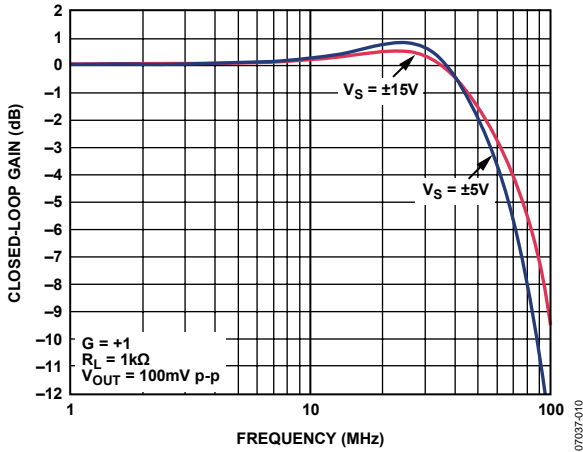

Figure 11. Small Signal Frequency Response for Various Supply Voltages

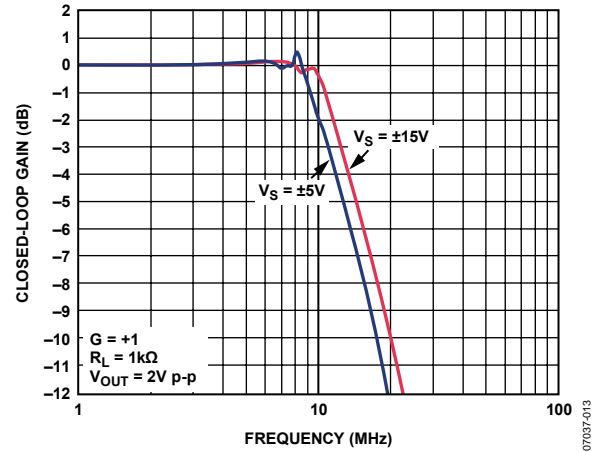

Figure 14. Large Signal Frequency Response for Various Supply Voltages

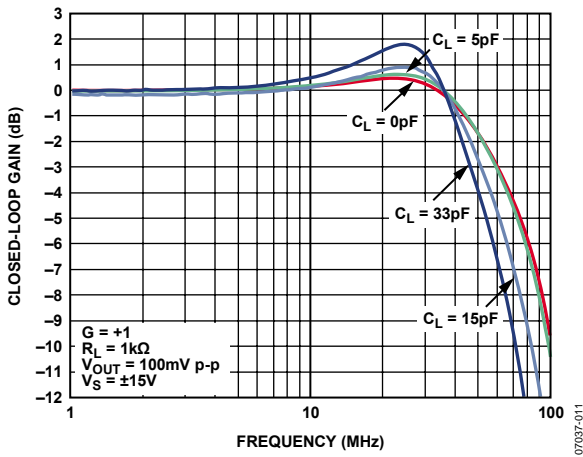

Figure 12. Small Signal Frequency Response for Various Capacitive Loads

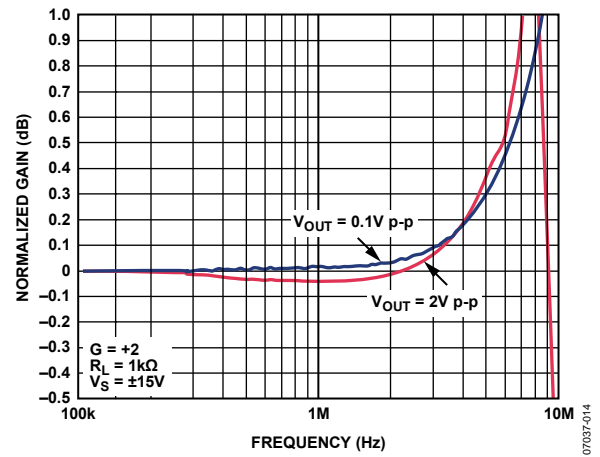

Figure 15. 0.1 dB Flatness for Various Output Voltages

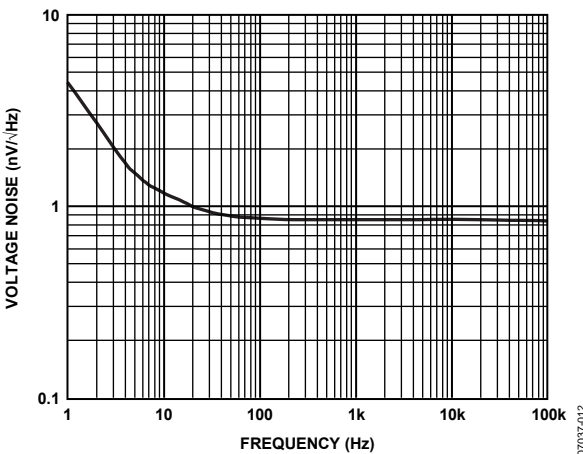

Figure 13. Voltage Noise vs. Frequency

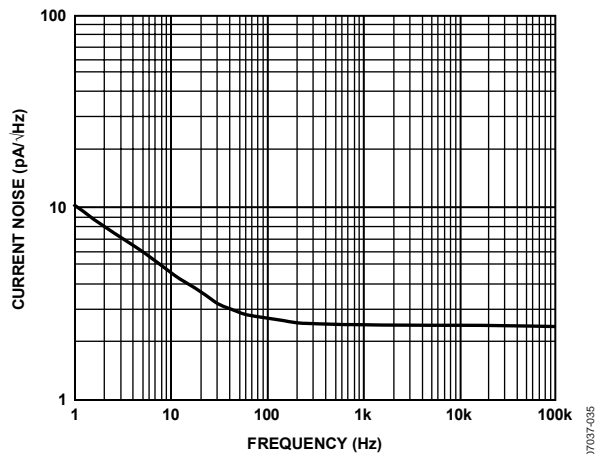

Figure 16. Input Current Noise vs. Frequency

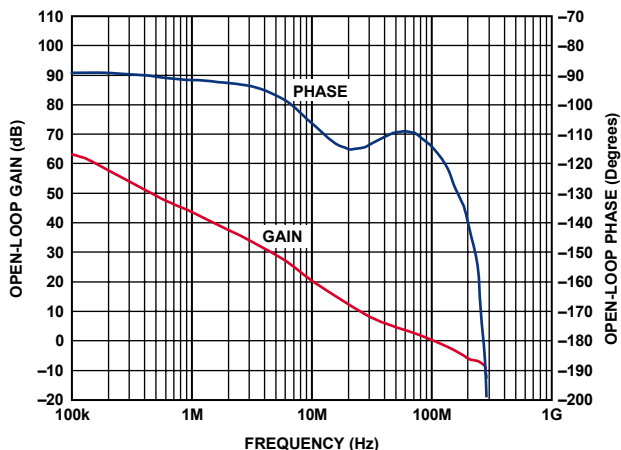

Figure 17. Open-Loop Gain and Phase vs. Frequency

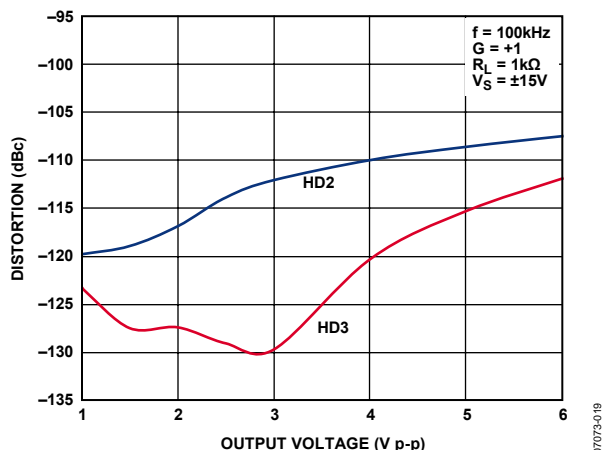

Figure 20. Harmonic Distortion vs. Output Amplitude

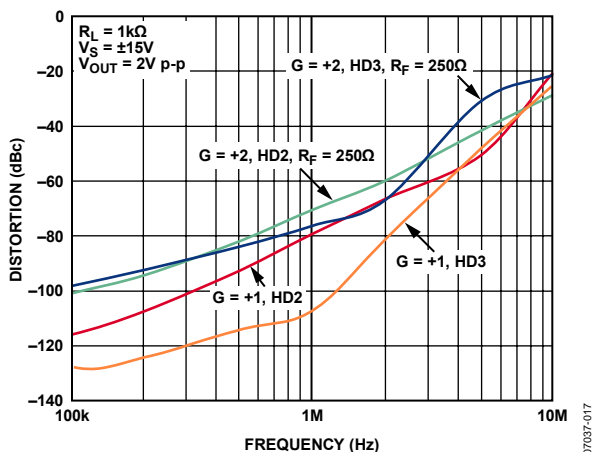

Figure 18. Harmonic Distortion vs. Frequency and Gain

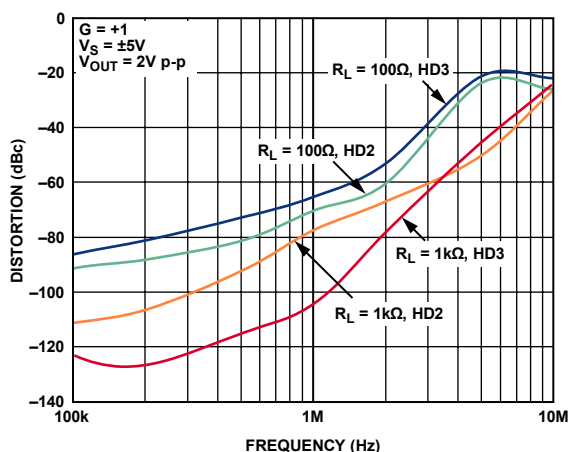

Figure 21. Harmonic Distortion vs. Frequency and Loads

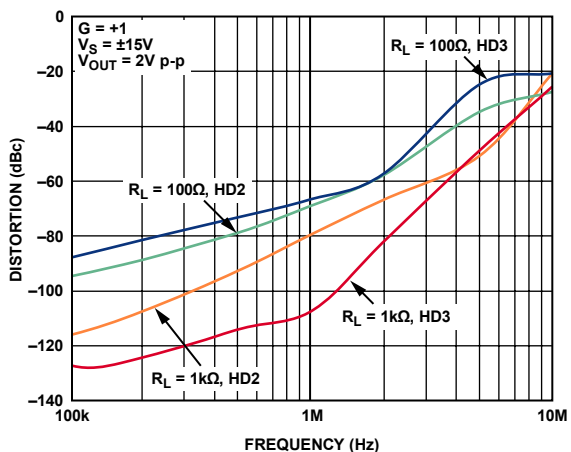

Figure 19. Harmonic Distortion vs. Frequency and Loads

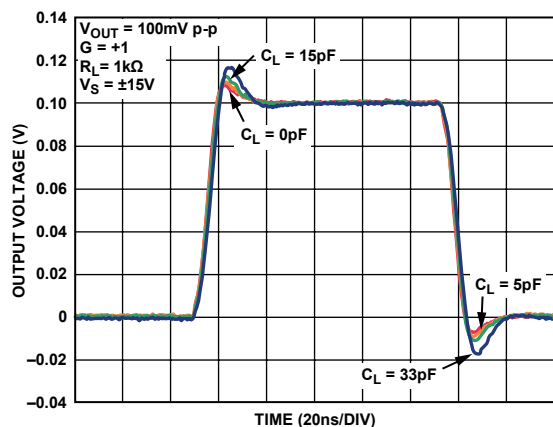

Figure 22. Small Signal Transient Response for Various Capacitive Loads

ADA4898-1

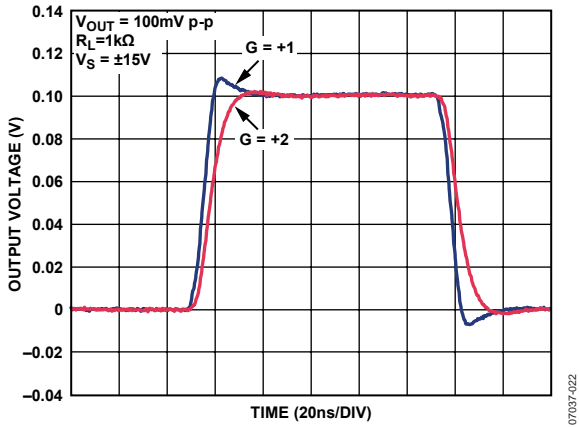

Figure 23. Small Signal Transient Response for Various Gains

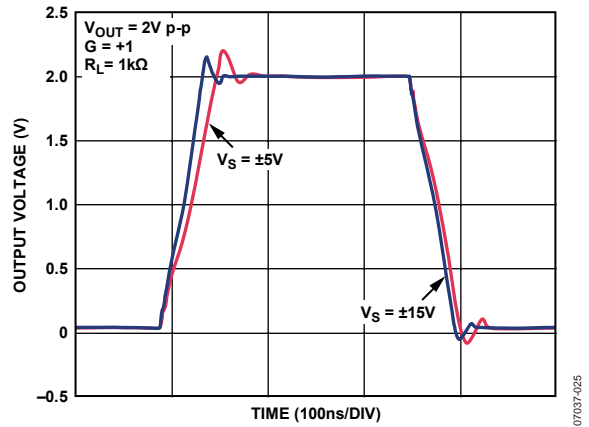

Figure 26. Large Signal Transient Response for Various Supply Voltages, $R_L = 1\text{ k}\Omega$

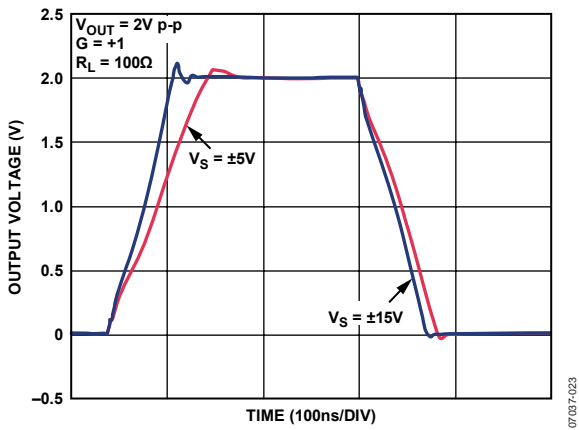

Figure 24. Large Signal Transient Response for Various Supply Voltages, $R_L = 100\ \Omega$

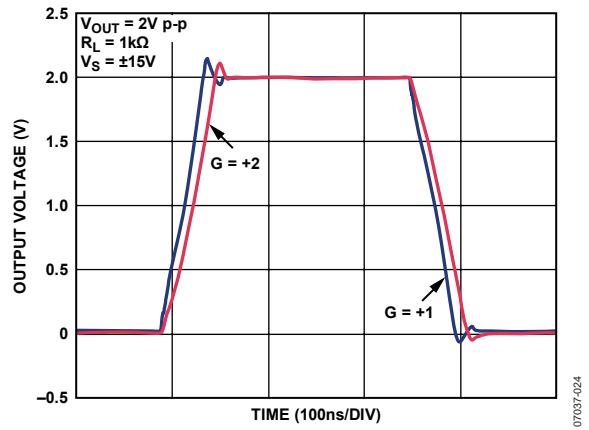

Figure 27. Large Signal Transient Response for Various Gains

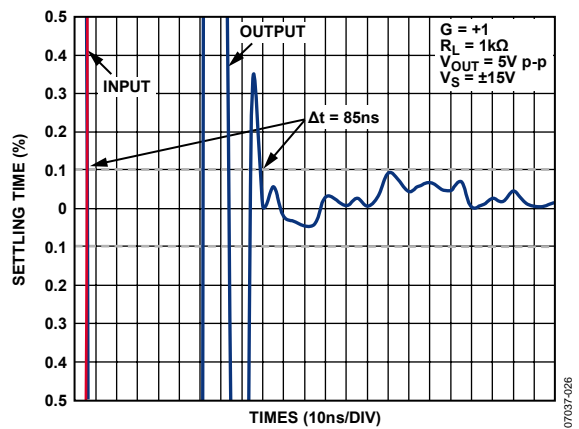

Figure 25. Settling Time

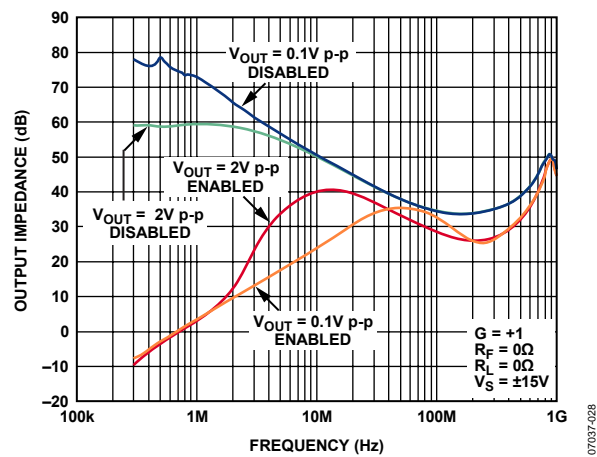

Figure 28. Output Impedance vs. Frequency

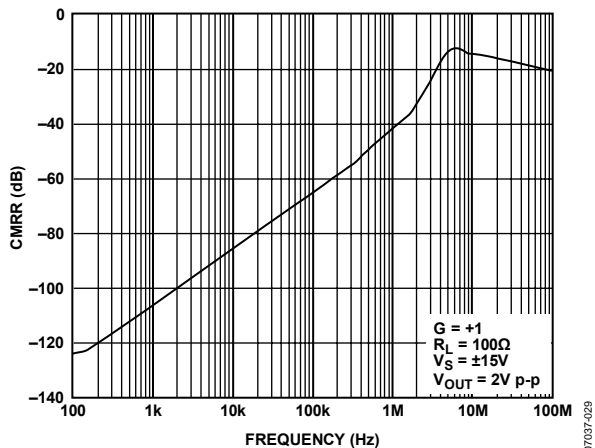

Figure 29. Common-Mode Rejection Ratio (CMRR) vs. Frequency

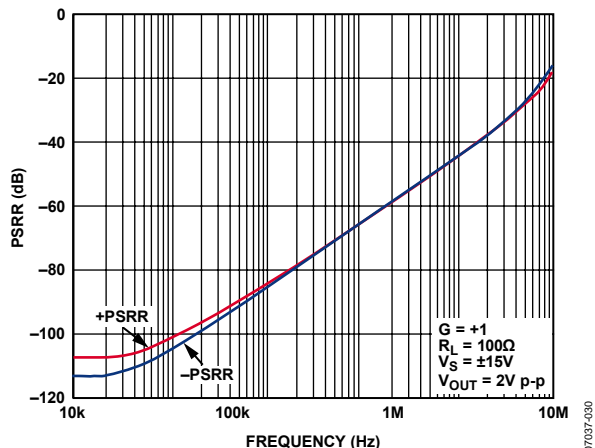

Figure 32. Power Supply Rejection Ratio (PSRR) vs. Frequency

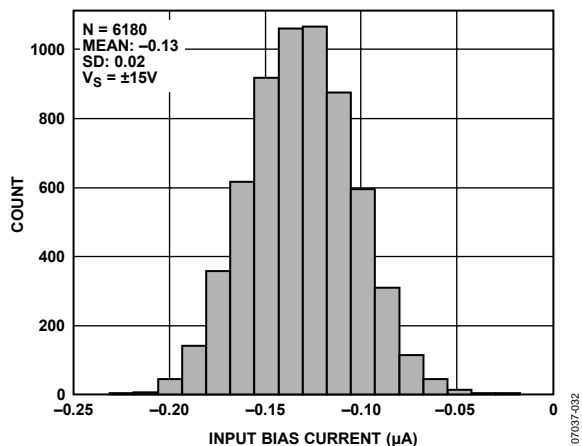

Figure 30. Input Bias Current Distribution

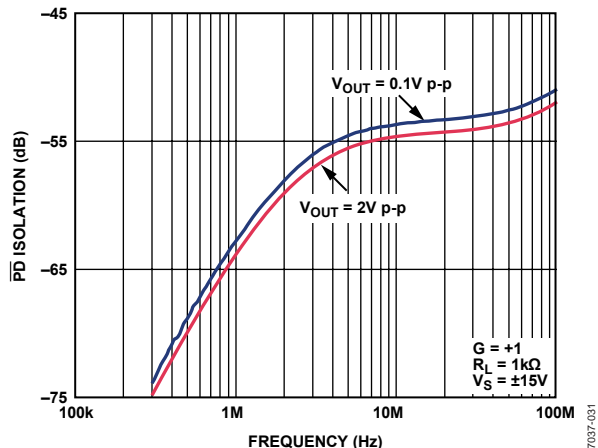

Figure 33. PD Isolation vs. Frequency

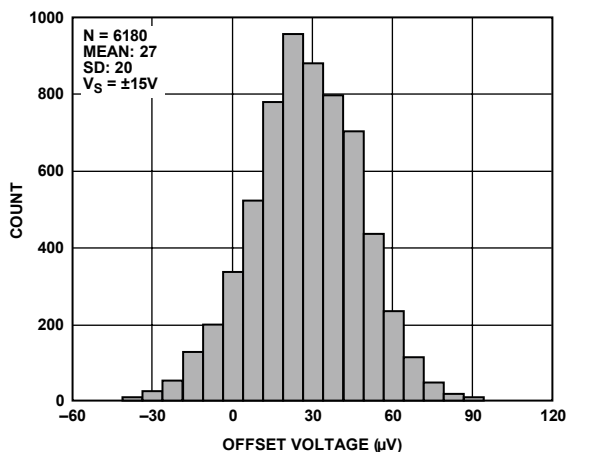

Figure 31. Input Offset Voltage Distribution, $V_S = \pm 15V$

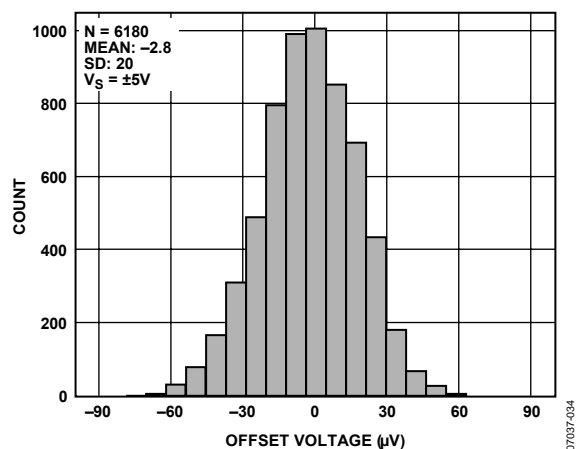

Figure 34. Input Offset Voltage Distribution, $V_S = \pm 5V$

TEST CIRCUITS

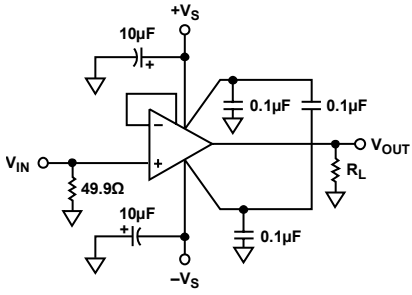

Figure 35. Typical Noninverting Load Configuration

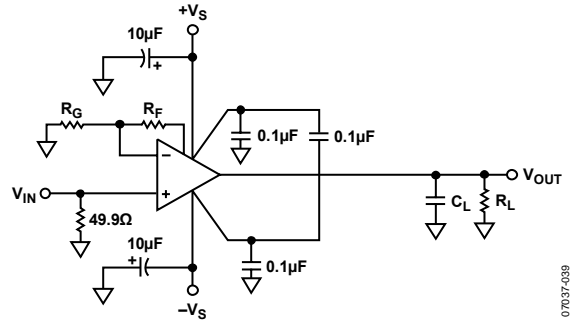

Figure 38. Typical Capacitive Load Configuration

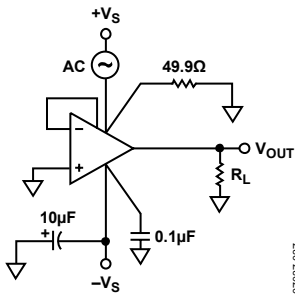

Figure 36. Positive Power Supply Rejection

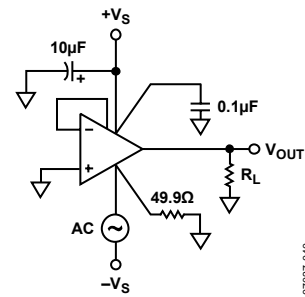

Figure 39. Negative Power Supply Rejection

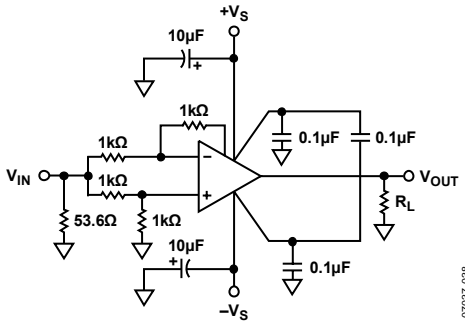

Figure 37. Common-Mode Rejection

THEORY OF OPERATION

The ADA4898-1 is a voltage feedback op amp that combines unity-gain stability with 0.9 nV/√Hz input noise. It employs a highly linear input stage that can maintain greater than -90 dBc (@ 2 V p-p) distortion out to 500 kHz while in a unity-gain configuration. This rare combination of low gain stability, low input referred noise, and extremely low distortion is the result of Analog Devices, Inc., proprietary op amp architecture and high speed complementary bipolar processing technology.

The simplified ADA4898-1 topology, shown in Figure 40, is a single gain stage with a unity-gain output buffer. It has over 100 dB of open-loop gain and maintains precision specifications such as CMRR, PSRR and offset to levels that are normally associated with topologies having two or more gain stages.

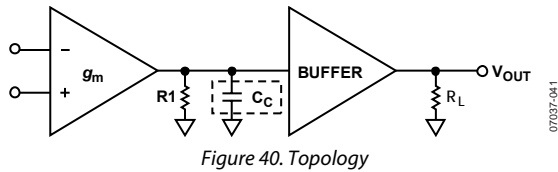

Figure 40. Topology

$\overline{\text{PD}}$ (POWER DOWN) PIN

The $\overline{\text{PD}}$ pin saves power by decreasing the quiescent power dissipated in the device. It is very useful when power is an issue and the device does not need to be turned on at all times. The response of the device is rapid when going from a power down mode to full power operation mode. Note that $\overline{\text{PD}}$ does not put the output in a high-Z state, which means that the ADA4898-1 is not recommended for use as a multiplexer.

CURRENT NOISE MEASUREMENT

To measure the very low (2.4 pA/√Hz) input current noise of the ADA4898-1, 10 kΩ resistors were used on both inputs of the amplifier. Figure 41 shows the noise measurement circuit used. The 10 kΩ resistors are used on both inputs to balance the input impedance and cancel the common-mode noise. In addition, a high gain configuration is used to increase the total output noise and bring it above the noise floor of the instrument.

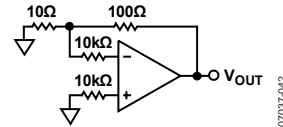

Figure 41. Current Noise Measurement Circuit

The current noise density (I_n) is calculated using the following formula:

$$I_n = \frac{\left[e_{no}^2 - (11 \times 18.4 \text{ nV}/\sqrt{\text{Hz}})^2 \right]^{1/2} \times \sqrt{2}}{20 \text{ k}\Omega \times 11}$$

APPLICATIONS INFORMATION

HIGHER FEEDBACK GAIN OPERATION

The ADA4898-1 schematic for the noninverting gain configuration is nearly a textbook example (see Figure 42). The only exception is the feedback capacitor in parallel with the feedback resistor, R_F , but this capacitor is recommended only when using a large R_F value ($>300 \Omega$). Figure 43 shows the difference between using a 100Ω resistor and a $1 \text{ k}\Omega$ resistor. Due to the high input capacitance in the ADA4898-1 when using a higher feedback resistor, more peaking appears in the closed-loop gain. Using the lower feedback resistor resolves this issue; however, when running at higher supplies ($\pm 15 \text{ V}$) with $100 \Omega R_F$, the system draws a lot of extra current into the feedback network. To avoid this problem, a higher feedback resistor can be used with a feedback capacitor in parallel. Figure 43 shows the effect of placing a feedback capacitor in parallel with a larger R_F . In this gain of 2 configuration, $R_F = R_G = 1 \text{ k}\Omega$ and $C_F = 2.7 \text{ pF}$. When using C_F , the peaking drops from 6 dB to less than 2 dB.

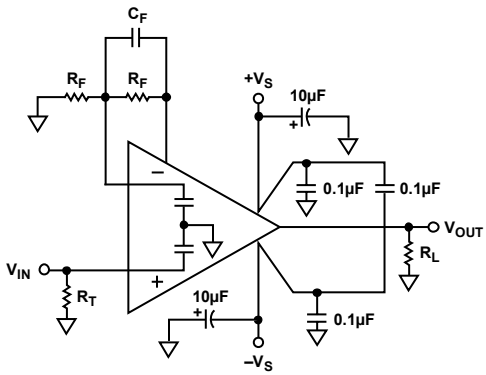

Figure 42. Noninverting Gain Schematic

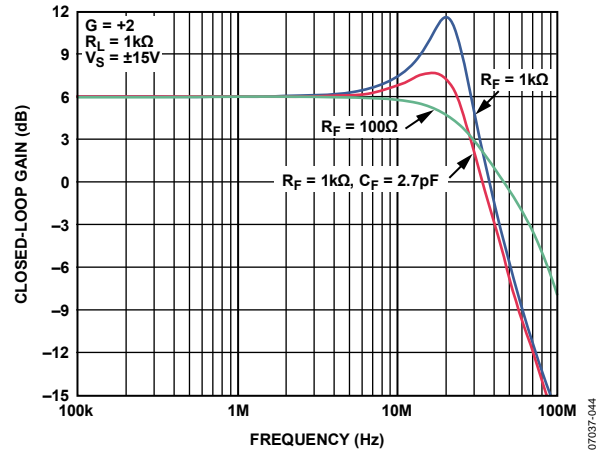

Figure 43. Small Signal Frequency Response for Various Feedback Impedances

RECOMMENDED VALUES FOR VARIOUS GAINS

Table 6 provides a useful reference for determining various gains and associated performance. Resistor R_F is set to 100Ω for gains greater than 1. A low feedback R_F resistor value reduces peaking and minimizes the contribution to the overall noise performance of the amplifier.

Table 6. Various Gains and Recommended Resistor Values Associated (Conditions: $V_S = \pm 5 \text{ V}$, $T_A = 25^\circ\text{C}$, $R_T = 1 \text{ k}\Omega$, $R_L = 49.9 \Omega$)

Gain	$R_F (\Omega)$	$R_G (\Omega)$	-3 dB SS BW (MHz), $V_{OUT} = 100 \text{ mV p-p}$	Slew Rate (V/ μs), $V_{OUT} = 2 \text{ V Step}$	ADA4898-1 Voltage Noise (nV/ $\sqrt{\text{Hz}}$), RTO	Total System Noise (nV/ $\sqrt{\text{Hz}}$), RTO
+1	0	NA	65	55	0.9	1.29
+2	100	100	30	50	1.8	3.16
+5	100	24.9	9	45	4.5	7.07

OUTLINE DIMENSIONS

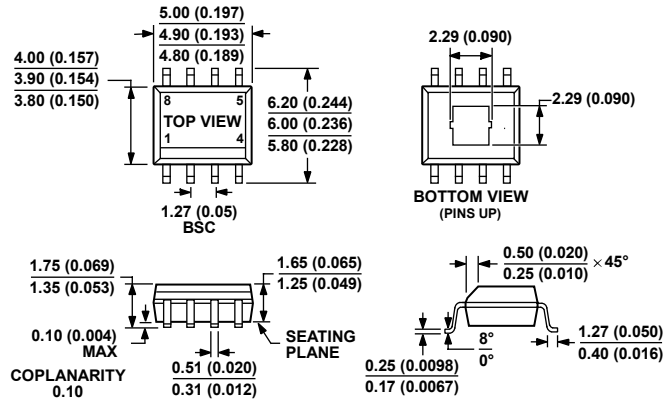

COMPLIANT TO JEDEC STANDARDS MS-012-AA

CONTROLLING DIMENSIONS ARE IN MILLIMETER; INCH DIMENSIONS (IN PARENTHESES) ARE ROUNDED-OFF MILLIMETER EQUIVALENTS FOR REFERENCE ONLY AND ARE NOT APPROPRIATE FOR USE IN DESIGN.

Figure 45. 8-Lead Standard Small Outline Package with Exposed Pad [SOIC_N_EP] (RD-8-1)

Dimensions shown in millimeters and (inches)

060506A

ORDERING GUIDE

Model	Temperature Range	Package Description	Package Option	Ordering Quantity
ADA4898-1YRDZ ¹	-40°C to +105°C	8-Lead SOIC_N_EP	RD-8-1	1
ADA4898-1YRDZ-R7 ¹	-40°C to +105°C	8-Lead SOIC_N_EP	RD-8-1	1,000
ADA4898-1YRDZ-RL ¹	-40°C to +105°C	8-Lead SOIC_N_EP	RD-8-1	2,500

¹ Z = RoHS Compliant Part.