

## Dual boost chopper Super Junction MOSFET Power Module

$$V_{DSS} = 600V$$

$$R_{DSon} = 70m\Omega \text{ max @ } T_j = 25^\circ C$$

$$I_D = 39A \text{ @ } T_c = 25^\circ C$$

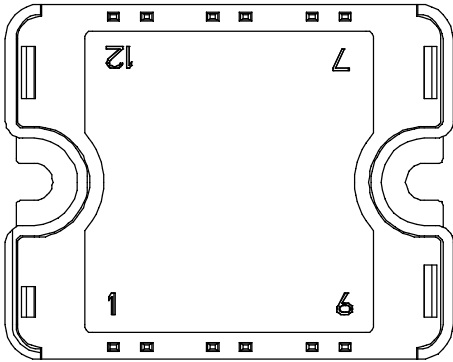
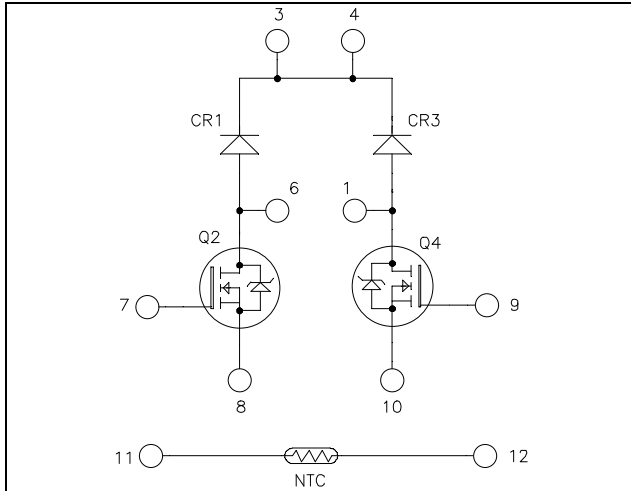

Pins 3/4 must be shorted together

### Application

- AC and DC motor control
- Switched Mode Power Supplies
- Power Factor Correction

### Features



- Ultra low  $R_{DSon}$
- Low Miller capacitance
- Ultra low gate charge
- Avalanche energy rated
- Very rugged

- Very low stray inductance
  - Symmetrical design
- Internal thermistor for temperature monitoring
- High level of integration

### Benefits

- Outstanding performance at high frequency operation
- Direct mounting to heatsink (isolated package)
- Low junction to case thermal resistance
- Solderable terminals both for power and signal for easy PCB mounting
- Each leg can be easily paralleled to achieve a single boost of twice the current capability
- Low profile
- RoHS Compliant

### Absolute maximum ratings

Symbol	Parameter	Max ratings	Unit
$V_{DSS}$	Drain - Source Breakdown Voltage	600	V
$I_D$	Continuous Drain Current	$T_c = 25^\circ C$	39
		$T_c = 80^\circ C$	29
$I_{DM}$	Pulsed Drain current	160	
$V_{GS}$	Gate - Source Voltage	$\pm 20$	V
$R_{DSon}$	Drain - Source ON Resistance	70	$m\Omega$
$P_D$	Maximum Power Dissipation	$T_c = 25^\circ C$	250
$I_{AR}$	Avalanche current (repetitive and non repetitive)	20	A
$E_{AR}$	Repetitive Avalanche Energy	1	mJ
$E_{AS}$	Single Pulse Avalanche Energy	1800	

**CAUTION:** These Devices are sensitive to Electrostatic Discharge. Proper Handling Procedures Should Be Followed. See application note APT0502 on [www.microsemi.com](http://www.microsemi.com)

All ratings @  $T_j = 25^\circ\text{C}$  unless otherwise specified

**Electrical Characteristics**

Symbol	Characteristic	Test Conditions	Min	Typ	Max	Unit
$I_{DSS}$	Zero Gate Voltage Drain Current	$V_{GS} = 0V, V_{DS} = 600V$			25	$\mu\text{A}$
		$T_j = 25^\circ\text{C}$				
		$V_{GS} = 0V, V_{DS} = 600V$			250	
$R_{DS(on)}$	Drain – Source on Resistance	$V_{GS} = 10V, I_D = 39A$			70	$\text{m}\Omega$
$V_{GS(th)}$	Gate Threshold Voltage	$V_{GS} = V_{DS}, I_D = 2.7\text{mA}$	2.1	3	3.9	V
$I_{GSS}$	Gate – Source Leakage Current	$V_{GS} = \pm 20V, V_{DS} = 0V$			$\pm 100$	nA

**Dynamic Characteristics**

Symbol	Characteristic	Test Conditions	Min	Typ	Max	Unit
$C_{iss}$	Input Capacitance	$V_{GS} = 0V$		7		nF
$C_{oss}$	Output Capacitance	$V_{DS} = 25V$		2.56		
$C_{rss}$	Reverse Transfer Capacitance	$f = 1\text{MHz}$		0.21		
$Q_g$	Total gate Charge	$V_{GS} = 10V$		259		nC
$Q_{gs}$	Gate – Source Charge	$V_{Bus} = 300V$		29		
$Q_{gd}$	Gate – Drain Charge	$I_D = 39A$		111		
$T_{d(on)}$	Turn-on Delay Time	<b>Inductive Switching @ <math>125^\circ\text{C}</math></b> $V_{GS} = 15V$ $V_{Bus} = 400V$ $I_D = 39A$ $R_G = 5\Omega$		21		ns
$T_r$	Rise Time			30		
$T_{d(off)}$	Turn-off Delay Time			283		
$T_f$	Fall Time			84		
$E_{on}$	Turn-on Switching Energy	<b>Inductive switching @ <math>25^\circ\text{C}</math></b> $V_{GS} = 15V, V_{Bus} = 400V$ $I_D = 39A, R_G = 5\Omega$		670		$\mu\text{J}$
$E_{off}$	Turn-off Switching Energy			980		
$E_{on}$	Turn-on Switching Energy	<b>Inductive switching @ <math>125^\circ\text{C}</math></b> $V_{GS} = 15V, V_{Bus} = 400V$ $I_D = 39A, R_G = 5\Omega$		1096		$\mu\text{J}$
$E_{off}$	Turn-off Switching Energy			1206		

**Chopper diode ratings and characteristics**

Symbol	Characteristic	Test Conditions	Min	Typ	Max	Unit
$V_{RRM}$	Maximum Peak Repetitive Reverse Voltage		600			V
$I_{RM}$	Maximum Reverse Leakage Current	$V_R = 600V$	$T_j = 25^\circ\text{C}$		25	$\mu\text{A}$
			$T_j = 125^\circ\text{C}$		500	
$I_F$	DC Forward Current	$T_c = 80^\circ\text{C}$		30		A
$V_F$	Diode Forward Voltage	$I_F = 30A$		1.8	2.2	V
		$I_F = 60A$		2.2		
		$I_F = 30A$	$T_j = 125^\circ\text{C}$		1.5	
$t_{rr}$	Reverse Recovery Time	$I_F = 30A$ $V_R = 400V$ $di/dt = 200A/\mu\text{s}$	$T_j = 25^\circ\text{C}$		25	ns
			$T_j = 125^\circ\text{C}$		160	
$Q_{rr}$	Reverse Recovery Charge	$I_F = 30A$ $V_R = 400V$ $di/dt = 200A/\mu\text{s}$	$T_j = 25^\circ\text{C}$		35	nC
			$T_j = 125^\circ\text{C}$		480	

## Thermal and package characteristics

Symbol	Characteristic	Min	Typ	Max	Unit	
R <sub>thJC</sub>	Junction to Case Thermal Resistance	CoolMOS		0.5	°C/W	
		Diode		1.2		
V <sub>ISOL</sub>	RMS Isolation Voltage, any terminal to case t = 1 min, I <sub>isol</sub> < 1mA, 50/60Hz	4000			V	
T <sub>J</sub>	Operating junction temperature range	-40		150	°C	
T <sub>STG</sub>	Storage Temperature Range	-40		125		
T <sub>C</sub>	Operating Case Temperature	-40		100		
Torque	Mounting torque	To heatsink	M4	2.5	4.7	N.m
Wt	Package Weight				80	g

## Temperature sensor NTC (see application note APT0406 on www.microsemi.com for more information).

Symbol	Characteristic	Min	Typ	Max	Unit
R <sub>25</sub>	Resistance @ 25°C		50		kΩ
ΔR <sub>25</sub> /R <sub>25</sub>			5		%
B <sub>25/85</sub>	T <sub>25</sub> = 298.15 K		3952		K
ΔB/B	T <sub>C</sub> = 100°C		4		%

$$R_T = \frac{R_{25}}{\exp\left[B_{25/85} \left(\frac{1}{T_{25}} - \frac{1}{T}\right)\right]}$$

T: Thermistor temperature  
 R<sub>T</sub>: Thermistor value at T

## SP1 Package outline (dimensions in mm)

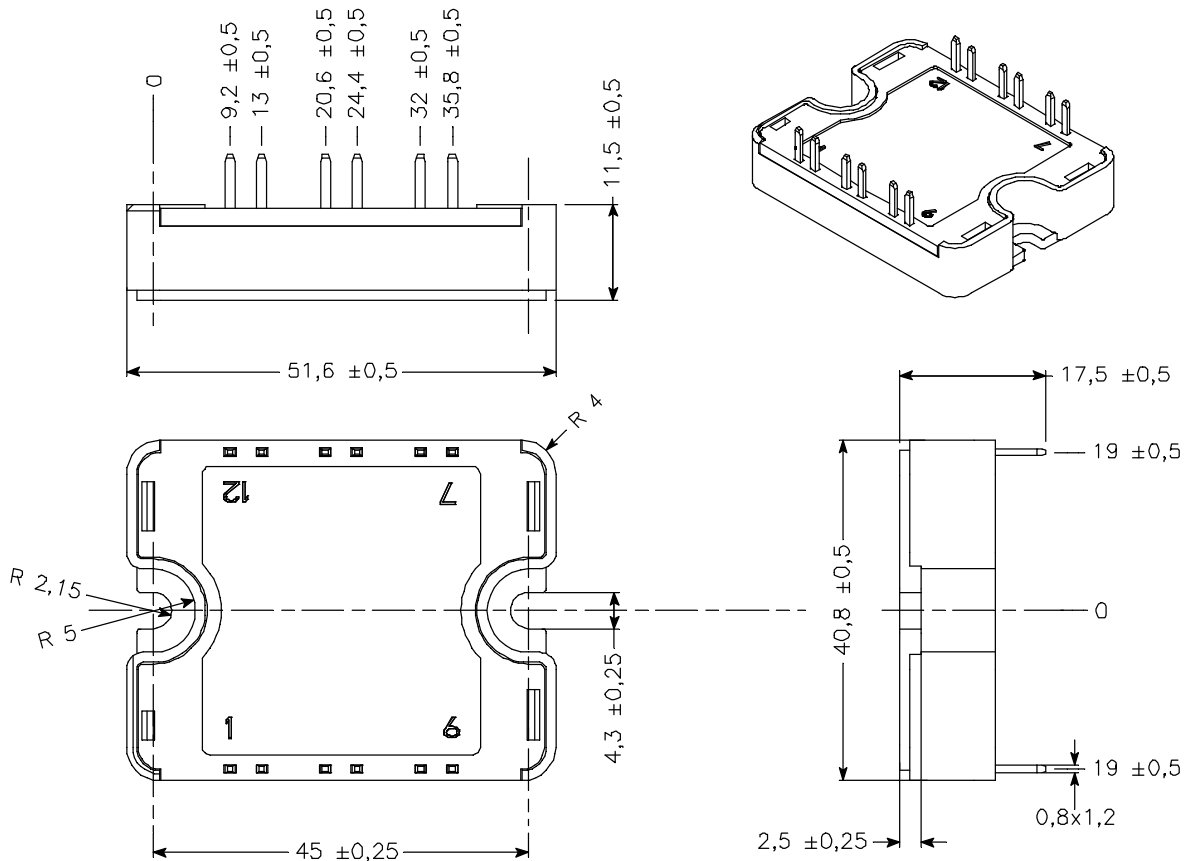

See application note 1904 - Mounting Instructions for SP1 Power Modules on [www.microsemi.com](http://www.microsemi.com)

## Typical CoolMOS Performance Curve

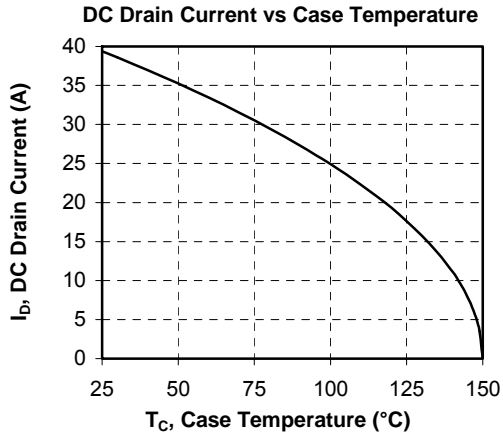
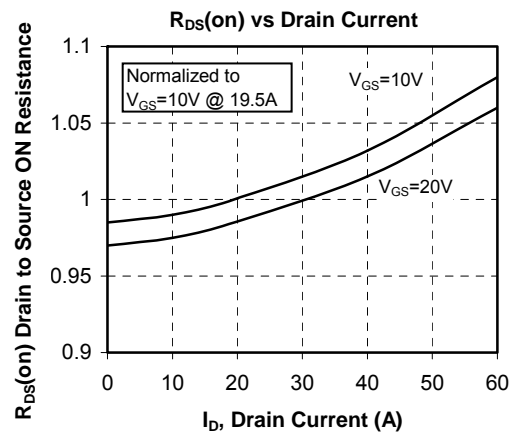
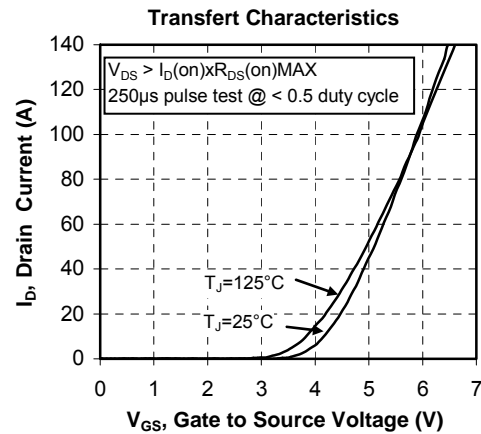
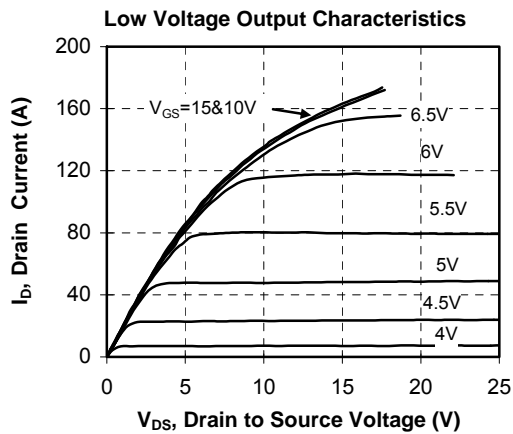
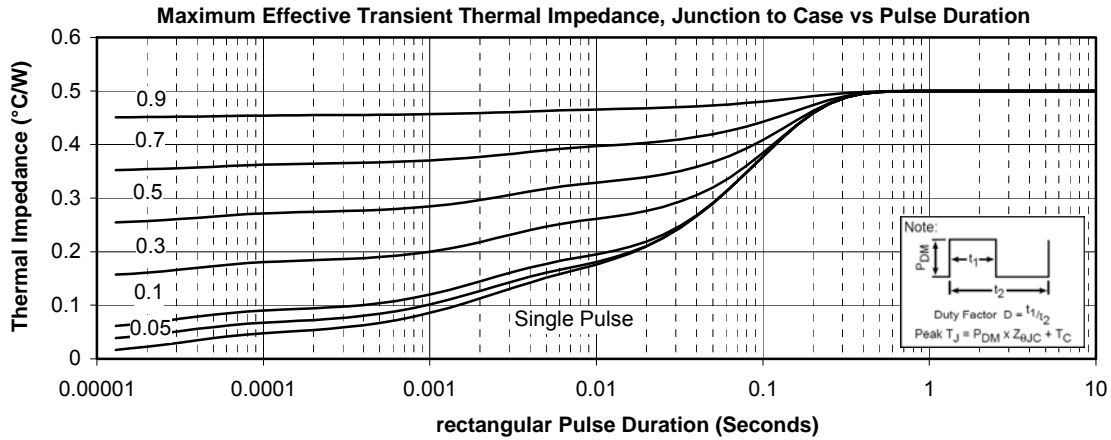

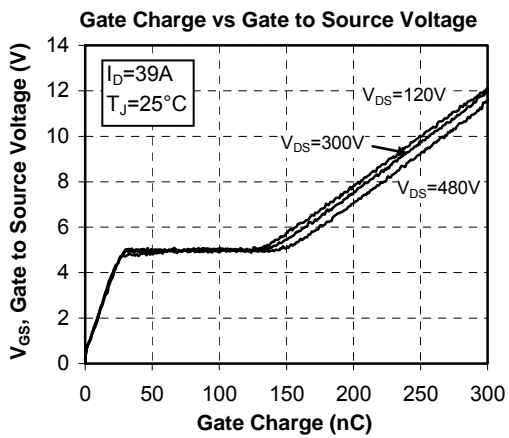
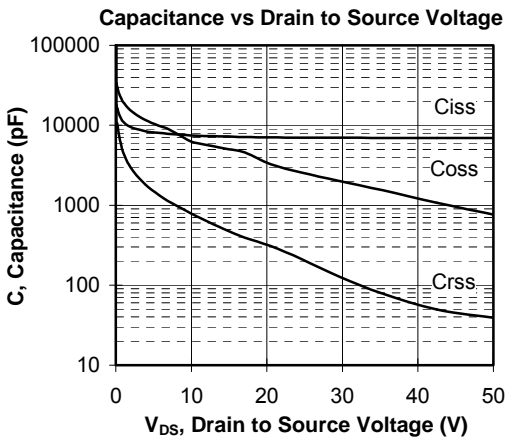
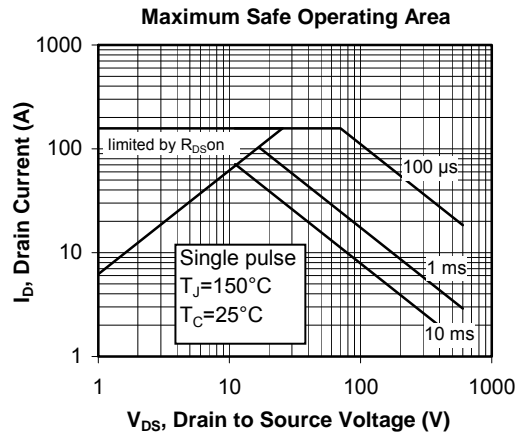
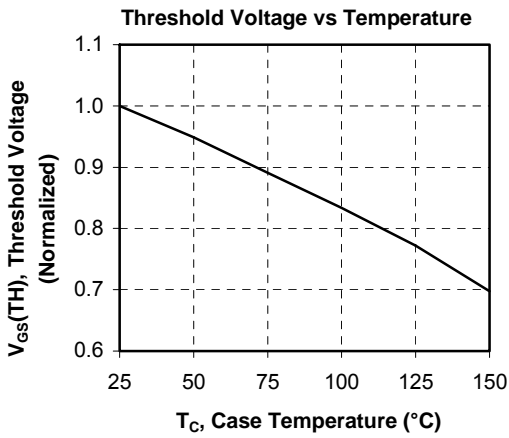
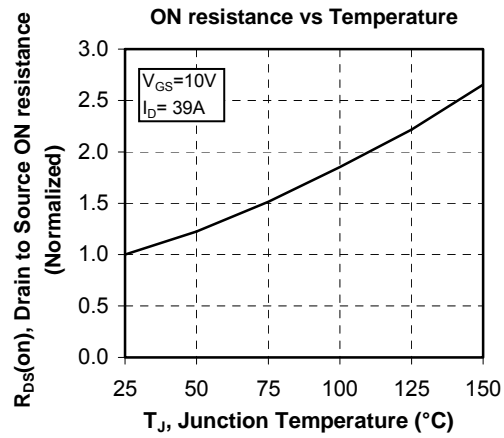
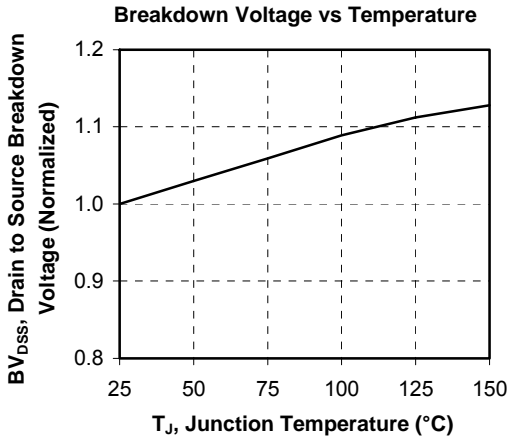

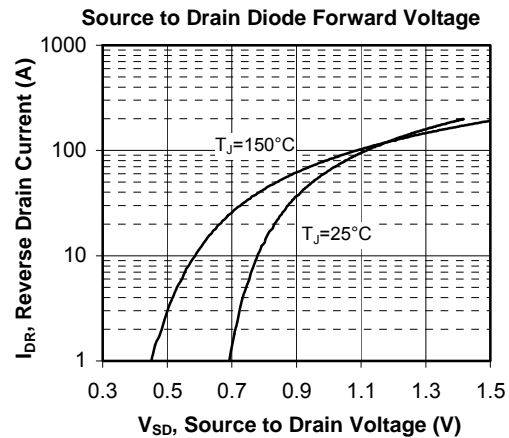
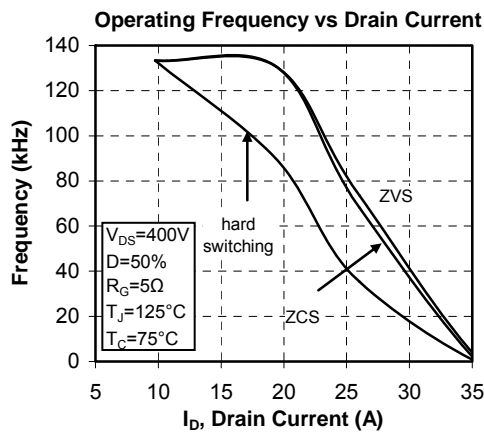
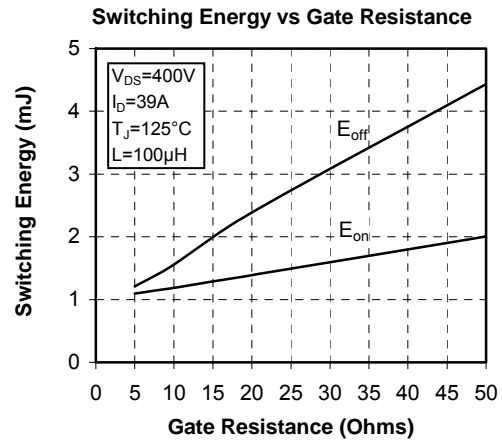
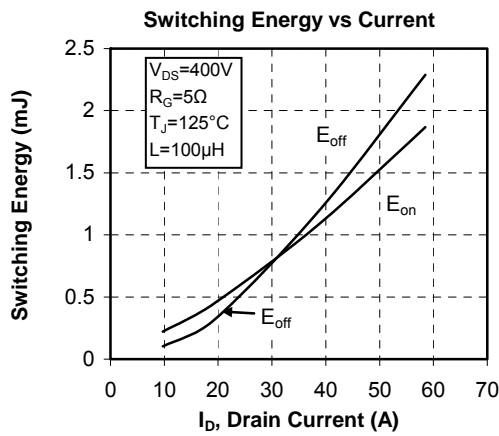
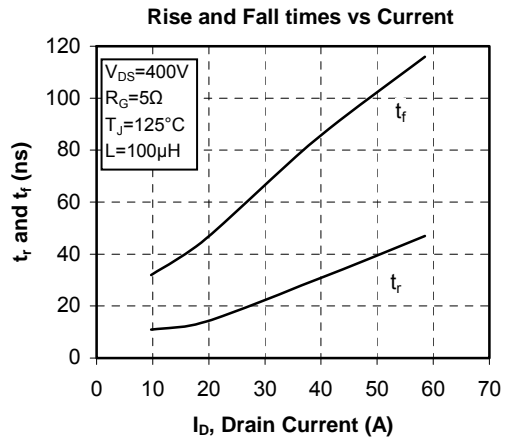
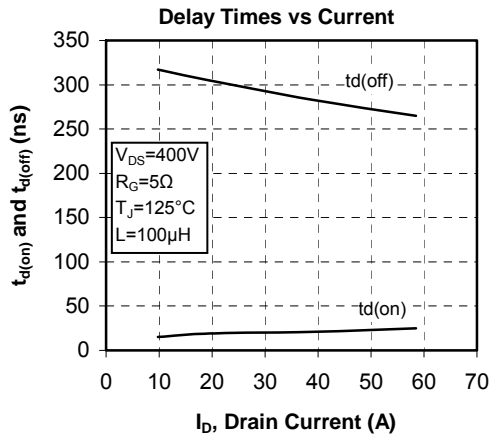

## Typical chopper diode Performance Curve

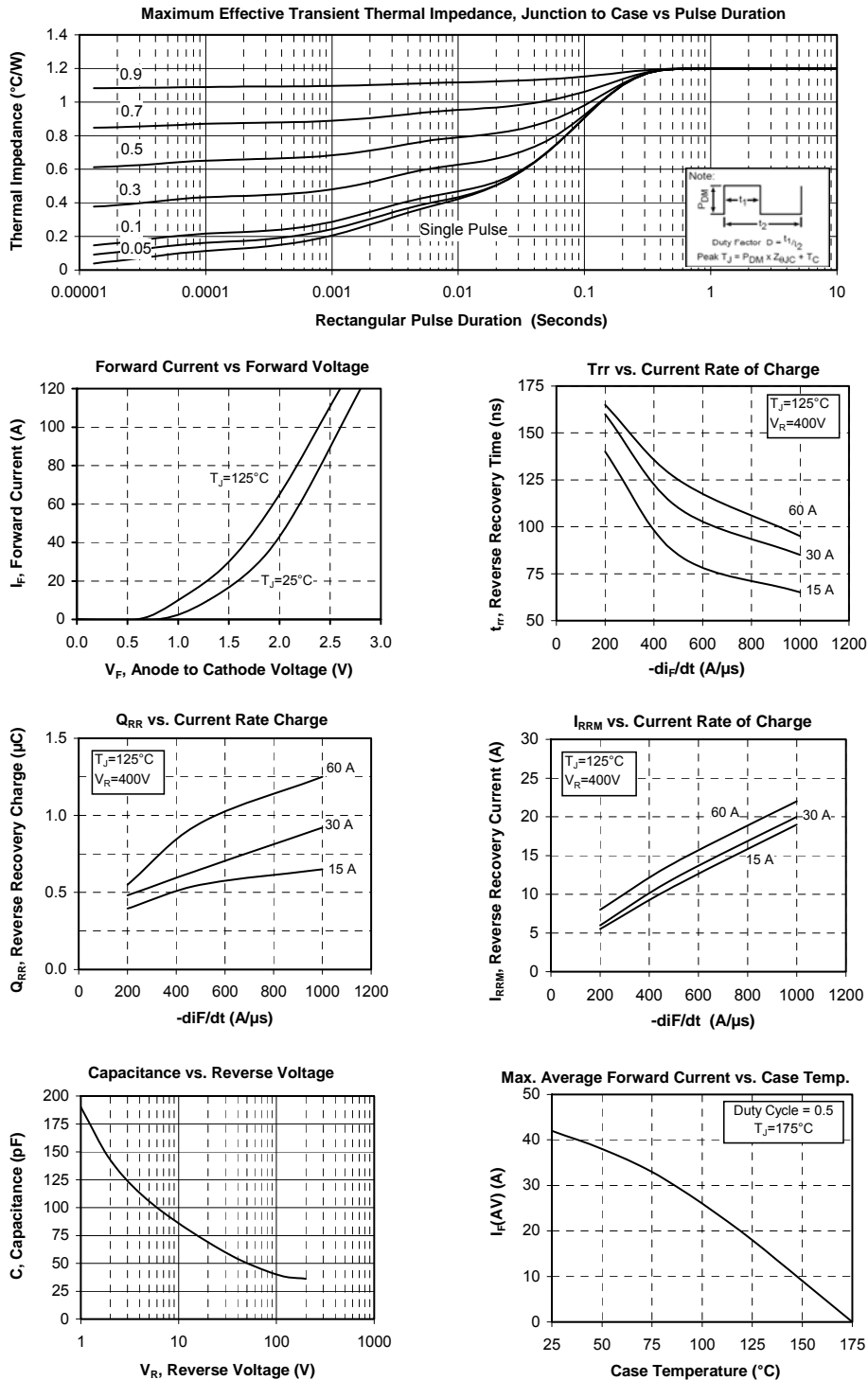

“COOLMOS™ comprise a new family of transistors developed by Infineon Technologies AG. “COOLMOS” is a trademark of Infineon Technologies AG”.

Microsemi reserves the right to change, without notice, the specifications and information contained herein

Microsemi's products are covered by one or more of U.S patents 4,895,810 5,045,903 5,089,434 5,182,234 5,019,522 5,262,336 6,503,786 5,256,583 4,748,103 5,283,202 5,231,474 5,434,095 5,528,058 6,939,743 7,352,045 5,283,201 5,801,417 5,648,283 7,196,634 6,664,594 7,157,886 6,939,743 7,342,262 and foreign patents. U.S and Foreign patents pending. All Rights Reserved.