

### Features

High Luminous LEDs  
 2x5x7mm Rectangular Standard Directivity  
 Superior Weather-resistance  
 UV Resistant Epoxy  
 Water Clear Type

### Applications

Electronic Signs And Signals  
 Small Area Illuminations  
 Back Lighting  
 Other Lighting

### Outline Dimension

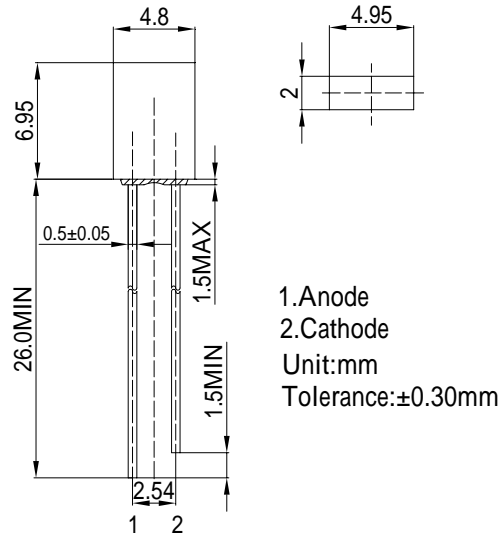

### Absolute Maximum Rating

(Ta=25 )

Item	Symbol	Value	Unit
DC Forward Current	I <sub>F</sub>	30	mA
Pulse Forward Current*	I <sub>FP</sub>	100	mA
Reverse Voltage	V <sub>R</sub>	5	V
Power Dissipation	P <sub>D</sub>	72	mW
Operating Temperature	Topr	-30 ~ +85	
Storage Temperature	Tstg	-40~ +100	
Lead Soldering Temperature	Tsol	260 /5sec	-

\*Pulse width Max.10ms Duty ratio max 1/10

### Directivity

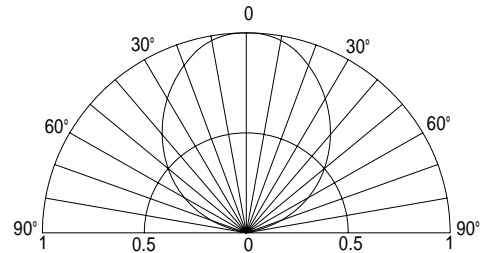

### Electrical -Optical Characteristics

(Ta=25 )

Item	Symbol	Condition	Min.	Typ.	Max.	Unit
DC Forward Voltage	V <sub>F</sub>	I <sub>F</sub> =20mA	1.8	2.1	2.4	V
DC Reverse Current	I <sub>R</sub>	V <sub>R</sub> =5V	-	-	10	μA
Domi. Wavelength*	λ <sub>D</sub>	I <sub>F</sub> =20mA	600	605	610	nm
Luminous Intensity*	I <sub>v</sub>	I <sub>F</sub> =20mA	-	700	-	mcd
50% Power Angle	2θ <sub>1/2</sub>	I <sub>F</sub> =20mA	-	100	-	deg

\*1 Tolerance of dominant wavelength is ±1nm

\*2 Tolerance of luminous intensity is ±15%