

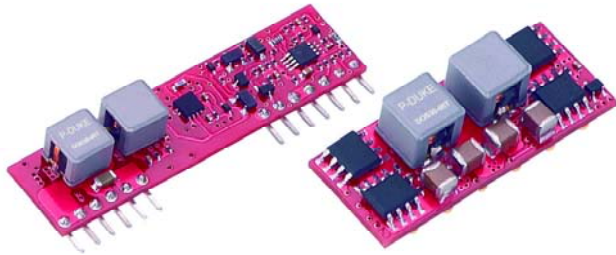

FEATURES

- OUTPUT CURRENT UP TO 30A
- SMALL SIZE AND LOW PROFILE :
1.30" X 0.53" X 0.35"(SMD) ; 2.00" X 0.50" X 0.35" (SIP)
- HIGH EFFICIENCY UP TO 93%@5VIN, 3.3Vo, FULL LOAD
- DOS(H)30-05T : 4.5VDC TO 5.5VDC INPUT; 0.8VDC TO 3.63VDC OUTPUT
DOS30-12T : 6.0VDC TO 14.0VDC INPUT; 0.8VDC TO 3.63VDC OUTPUT
DOH30-12T : 6.0VDC TO 14.0VDC INPUT; 0.8VDC TO 5.5VDC OUTPUT
OUTPUT VOLTAGE PROGRAMMABLE VIA EXTERNAL RESISTOR
- FIXED SWITCHING FREQUENCY (300KHZ)
- MONOTONIC START-UP INTO PRE-BIASED OUTPUT
- OUTPUT VOLTAGE SEQUENCING
- PARALLEL OPERATION WITH ACTIVE CURRENT SHARING
- DESIGN MEETS UL60950-1, EN60950-1 AND IEC60950-1
- ISO9001 CERTIFIED MANUFACTURING FACILITIES
- COMPLIANT TO RoHS EU DIRECTIVE 2002/95/EC



APPLICATIONS

Wireless Network
Telecom/Datacom
Industry Control System
Distributed Power Architectures
Semiconductor Equipment
Microprocessor Power Applications

OPTIONS

Positive Logic Remote on/off, Current Share, Extra GND Pin, Long Pins

DESCRIPTION

DOS30 (SMD type), DOH30 (SIP type) are non-isolated DC/DC converters that can deliver up to 30A of output current with full load efficiency of 93% at 5.0V input and 3.3V output.

TECHNICAL SPECIFICATION

All specifications are typical at nominal input, 3.3Vo, full load and 25°C otherwise noted

OUTPUT SPECIFICATIONS			
Output current	DOS30-05T	30A max.	
	DOH30-05T	30A max.	
	DOS30-12T	0.8 ≤ Vo ≤ 2.75V 2.75 < Vo ≤ 3.63V	30A max. 20A max.
	DOH30-12T	0.8 ≤ Vo ≤ 2.75V 2.75 < Vo ≤ 5.5V	30A max. 25A max.
	Voltage accuracy	Full load and Vin(nom.)	± 1.5%Vo(set)
Minimum load		0%	
Line regulation	Lin=Vin(min.) to Vin(max.) at Full Load	± 0.1%Vo(set), typ.	
Load regulation	No Load to Full Load	± 0.4%Vo(set), typ.	
Ripple and noise (Note 2)	20MHz bandwidth	75mVp-p	
Temperature coefficient		±0.5%, typ.	
Dynamic load response (Note 2)	ΔIo / Δt = 5A/uS, Vin(nom.)	Peak deviation	350mV, typ.
	Load change step (50% to 100% or 100% to 50% of Io(max))	Setting time (Vo < 10% peak deviation)	25uS, typ.
	ΔIo / Δt = 5A/uS, Vin(nom.)	Peak deviation	250mV, typ.
Dynamic load response (Note 3)	Load change step (50% to 100% or 100% to 50% of Io(max.))	Setting time (Vo < 10% peak deviation)	40uS, typ.
	Output current limit		150%, typ.
	Output short-circuit current	Hiccup, Automatics recovery	
External load capacitance	ESR ≥ 1mΩ	2000uF, max.	
	ESR ≥ 10mΩ	10000uF, max.	
Output voltage overshoot-startup	Lin=Vin(min.) to Vin(max.); F.L.	3%Vo(set), max.	
Voltage adjustability (see fig.1) (Note 4)	DOS30-05T	0.8V ~ 3.63V	
	DOH30-05T	0.8V ~ 3.63V	
	DOS30-12T	0.8V ~ 3.63V	
	DOH30-12T	0.8V ~ 5.5V	
GENERAL SPECIFICATIONS			
Efficiency		See table	
Isolation voltage		None	
Switching frequency		300KHz, typ.	
Design meet safety standard		IEC60950-1, UL60950-1, EN60950-1	
Dimensions	SMD	1.30 X 0.53 X 0.35 Inch (33.0 X 13.5 X 8.8 mm)	
	SIP	2.00 X 0.50 X 0.35 Inch (50.8 X 12.7 X 8.8 mm)	
Weight	SMD	6.0g(0.21oz)	
	SIP	7.0g(0.25oz)	
MTBF (Note 1)	BELLCORE TR-NWT-000332	3.145 x 10 ⁶ hrs	
	MIL-HDBK-217F	3.626 x 10 ⁵ hrs	

INPUT SPECIFICATIONS			
Input voltage range	DOS30-05T	Lin(nom) =5V	4.5 – 5.5VDC
	DOH30-05T		Lin,min=Vo(set)+1.5V
	DOS30-12T	Lin(nom) =12V	6.0 – 14.0VDC
	DOH30-12T		Lin,min=Vo(set)+2.4V
Maximum input current	Lin(min.) to Lin(max.); Io=Io(max.)		27A
Input filter (Note 5)			C filter
Input under-voltage lockout	Start-up voltage		4.4V, typ
	Shutdown voltage		4.3V, typ
Input reflected ripple current (Note 6)	5~20MHz, 1uH source impedance		100mA p-p
ENVIRONMENTAL SPECIFICATIONS			
Operating ambient temperature			-40°C ~ +85°C(with derating)
Storage temperature range			-55°C ~ +125°C
Thermal shock			MIL-STD-810F
Over temperature protection			125°C, typ.
FEATURE SPECIFICATIONS			
Sequencing delay time (Note 7)			10msec, min.
Tracking accuracy	Power-up (2V/ms)	VSEQ – Vo Lin(min.) to Lin(max.); Io(min.)	100mV, typ.
	Power-down (1V/ms)	to Io(max.); VSEQ < Vo.	200mV, typ.
Active load share (option) (Note 8)	Accuracy		10% Io
	Number of units in parallel		5, max.
Remote ON/OFF (Note 9)			
Negative logic(standard)	ON = -0.3V < Vr < 1.2V	IIN=200 μA, max.	
	OFF = 3.0V < Vr < Vin(max.)	IIN=3.3mA, max.	
Positive logic(option)	ON = 3.0V < Vr < Vin(max.)	IIN=200 μA, max.	
	OFF= -0.3V < Vr < 1.2V	IIN=3.3mA, max.	
Remote sense range			0.5V, max.
Rise time	Time for Vo to rise from 10% to 90%of Vo(set)		10ms, max.
Turn-on delay time	Case 1 (Note 10)		2.5ms, typ.
	Case 2 (Note 11)		2.5ms, typ.

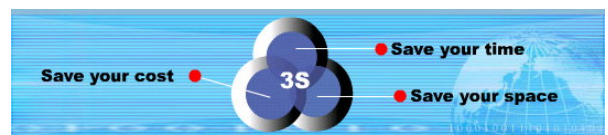

Model Name	Package	Input Voltage	Output Voltage	Output Current		Efficiency (%) Vin(nom.), 3.3Vdc, Full Load
				Min. Load	Max. Load	
DOS30-05T	SMD	4.5 ~ 5.5Vdc Vin,min=Vo(set)+1.5V	0.8 ~ 3.63Vdc	0A	30A	93%
DOH30-05T	SIP			0A	30A	
DOS30-12T	SMD	6.0 ~ 14.0Vdc Vin,min=Vo(set)+2.4V	0.8 ≤ Vo ≤ 2.75Vdc 2.75 < Vo ≤ 3.63Vdc	0A	30A	90%
DOH30-12T	SIP			0A	20A	
				0A	30A	90%
					25A	

Note

- BELLCORE TR-NWT-000332. Case 1: 50% Stress, Temperature at 40°C. MIL-HDBK-217F Notice2 @Ta=25 °C, Full load(Ground, Benign, controlled environment).
- External with C_{out} = 1uF ceramic/10uF tantalum capacitors.
- External with C_{out} = 2x150uF polymer capacitors.
- Output voltage programmable from 0.8V to 5.0V by connecting a single resistor (shown as R_{trim} in Table 1) between the TRIM and GND pins of the module. To calculate the value of the resistor **R_{trim}** for a particular output voltage **V_o**, use the following equation:

$$R_{trim} = \left[\frac{1200}{V_o - 0.80} - 100 \right] \Omega$$
- To make sure the module is stable, input external capacitors is necessary that minimize input ripple voltage of the module.
- To minimize input reflected ripple. External π filter is recommended at the input of the module. The filter is shown as figure2.
- Delay from Vin,min to application of voltage on SEQ pin.
- Selecting current share function that the regulations may not meet listed specification.
- The On/Off signal is referenced to ground. The standard remote On/Off logic of the device is negative logic. Adding a device code suffix "-P" is option for positive logic of remote On/Off.
- Case 1 :On/Off input is set to logic low (module on) and then input power is applied (delay from instant at which Vin=Vin(min) until Vo=10% of Vo(set))
- Case 2 :Input power is applied for at least one second and then the On/Off input is set to logic low (delay form instant at which Von/off=0.3V until Vo=10% of Vo(set))

CAUTION: This power module is not internally fused. An input line fuse must always be used.

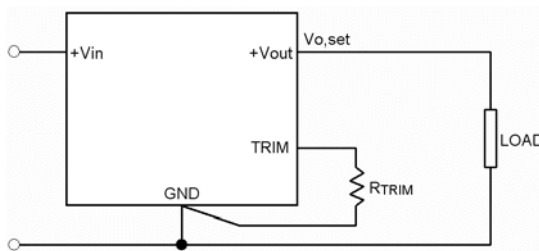

Figure 1.

Table 1. Trim Table

Vo(set) (V)	Rtrim (Ω)
0.8	Open
1.2	2900
1.5	1614
1.8	1100
2.5	605
3.3	380
5.0	185

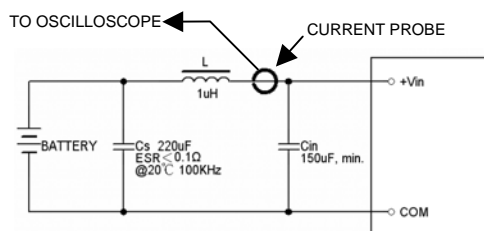
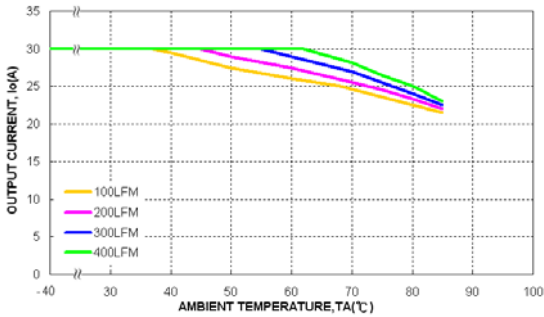

Figure 2.

Table 2. Device Options

Option	Suffix
Remote On/Off Positive Logic	-P
Current Share	-S
Extra GND pin 2 extra GND pins only for SMD TYPE	-E
Long Pins 5.08mm±0.25mm only for SIP TYPE	-L

DOS30-05T, Vo=3.3V Derating Curve



SIP TYPE

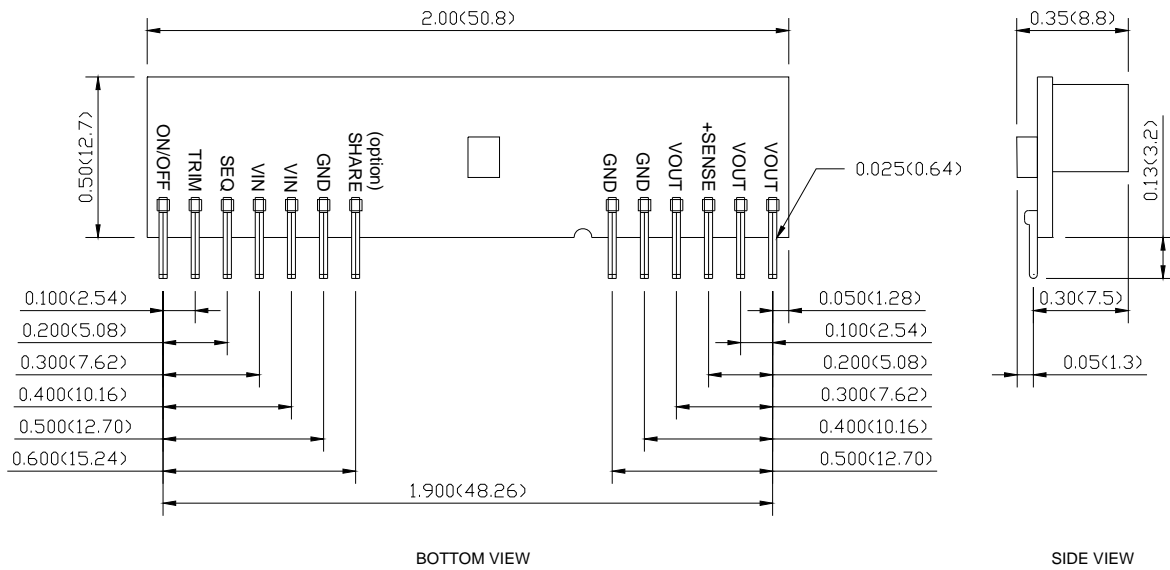

SMD TYPE

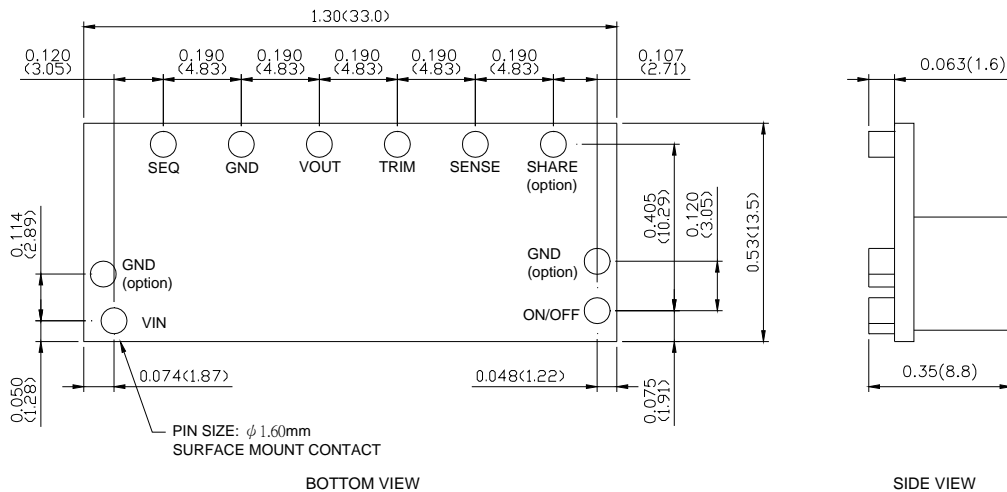

- All dimensions in Inches (mm)
Tolerance: X.XX±0.02 (X.X±0.5)
X.XXX±0.01 (X.XX±0.25)
- Pin pitch tolerance ±0.01(0.25)
- Pin dimension tolerance ±0.004 (0.1)