

P-CHANNEL ENHANCEMENT MODE POWER MOSFET

MTP2603Q6

Description

The MTP2603Q6 is a P-channel enhancement-mode MOSFET, providing the designer with the best combination of fast switching, ruggedized device design, low on-resistance and cost effectiveness.

The TSOP-6 package is universally preferred for all commercial-industrial surface mount applications.

Features

- Simple drive requirement
- Low on-resistance
- Small package outline
- Pb-free package

Equivalent Circuit

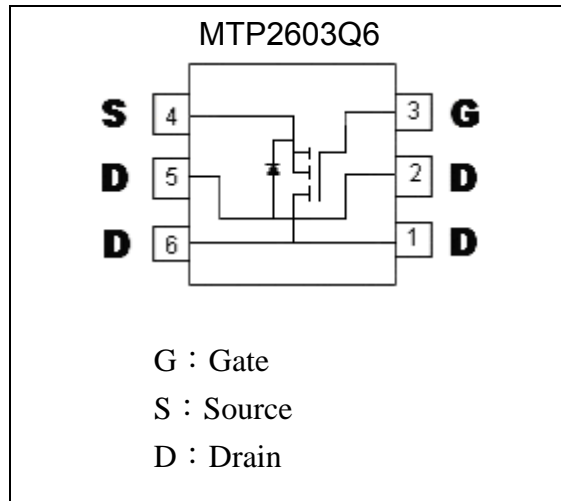

Absolute Maximum Ratings (Ta=25°C)

Parameter	Symbol	Limits	Unit
Drain-Source Voltage	VDS	-20	V
Gate-Source Voltage	VGS	±12	V
Continuous Drain Current @TA=25 °C (Note 1)	ID	-5	A
Continuous Drain Current @TA=70 °C (Note 1)	ID	-4	A
Pulsed Drain Current (Note 2, 3)	IDM	-20	A
Total Power Dissipation @ TA=25 °C Linear Derating Factor	Pd	2	W
		0.016	W / °C
Operating Junction Temperature	Tj	-55~+150	°C
Storage Temperature	Tstg	-55~+150	°C
Thermal Resistance, Junction-to-Ambient (Note 1)	Rth,ja	62.5	°C/W

Note : 1.Surface mounted on 1 in² copper pad of FR-4 board. 156°C/W when mounted on minimum copper pad.
 2.Pulse width limited by maximum junction temperature.
 3.Pulse Width ≤300µs, Duty Cycle≤2%



Electrical Characteristics (Ta=25°C, unless otherwise noted)

Symbol	Min.	Typ.	Max.	Unit	Test Conditions
BV _{DSS}	-20	-	-	V	V _{GS} =0, I _D =-250μA
ΔBV _{DSS} /ΔT _j	-	-0.1	-	V/°C	Reference to 25°C, I _D =-1mA
V _{GS(th)}	-0.5	-	-1.2	V	V _{DS} =V _{GS} , I _D =-250μA
I _{GSS}	-	-	±100	nA	V _{GS} =±12V, V _{DS} =0
I _{DSS}	-	-	-1	μA	V _{DS} =-20V, V _{GS} =0, T _j =25°C
I _{DSS}	-	-	-10	μA	V _{DS} =-16V, V _{GS} =0, T _j =55°C
*R _{DS(ON)}	-	-	53	mΩ	I _D =-4.5A, V _{GS} =-10V
	-	-	65		I _D =-4.2A, V _{GS} =-4.5V
	-	-	120		I _D =-2.0A, V _{GS} =-2.5V
	-	-	250		I _D =-1.0A, V _{GS} =-1.8V
*G _{FS}	-	9	-	S	V _{DS} =-5V, I _D =-2.8A
C _{iss}	-	740	1200	pF	V _{DS} =-15V, V _{GS} =0, f=1MHz
C _{oss}	-	167	-		
C _{rss}	-	126	-		
t _{d(ON)}	-	5.9	-	ns	V _{DS} =-15V, I _D =-4.2A, V _{GS} =-10V, R _{GEN} =6Ω, R _D =3.6Ω
t _r	-	3.6	-	ns	
t _{d(OFF)}	-	32.4	-	ns	
t _f	-	2.6	-	ns	
Q _g	-	10.6	16	nC	V _{DS} =-16V, I _D =-4.2A, V _{GS} =-4.5V,
Q _{gs}	-	2.32	-	nC	
Q _{gd}	-	3.68	-	nC	

*Pulse Test : Pulse Width ≤300μs, Duty Cycle≤2%

Source Drain Diode

Symbol	Min.	Typ.	Max.	Unit	Test Conditions
*V _{SD}	-	-	-1.2	V	I _S =-1.2A, V _{GS} =0V
*T _{rr}	-	27.7	-	ns	I _S =-4.2A, V _{GS} =0V, dI/dt=100A/μs
Q _{rr}	-	22	-	nC	

*Pulse Test : Pulse Width ≤300μs, Duty Cycle≤2%

Characteristic Curves

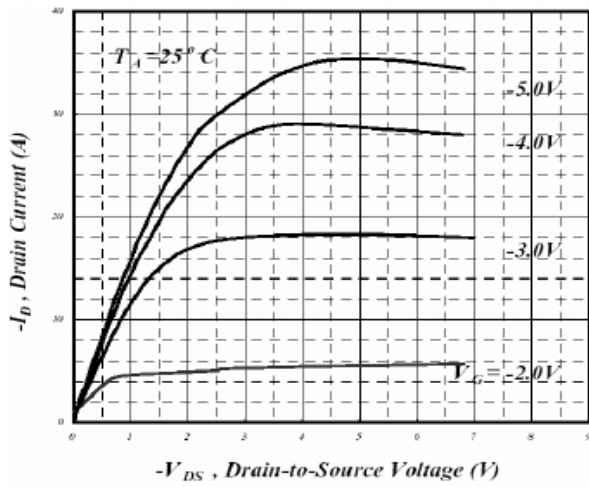

Fig 1. Typical Output Characteristics

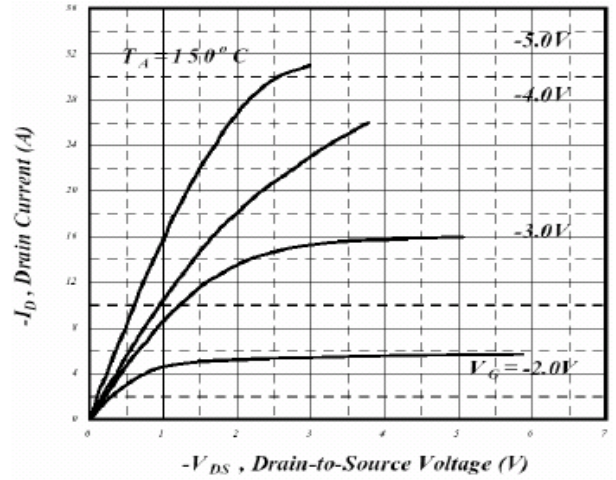

Fig 2. Typical Output Characteristics

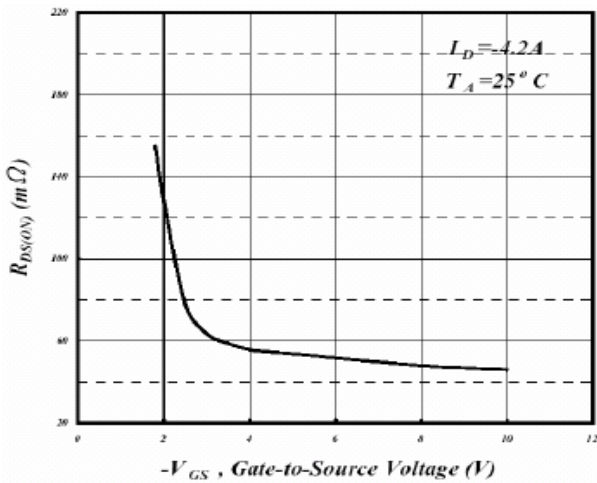

Fig 3. On-Resistance v.s. Gate Voltage

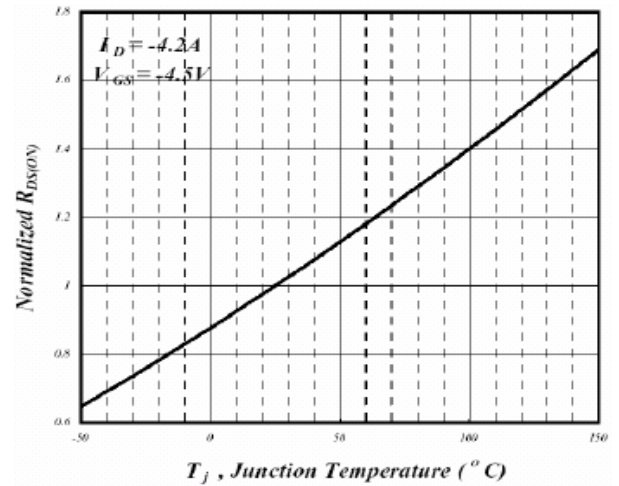

Fig 4. Normalized On-Resistance v.s. Junction Temperature

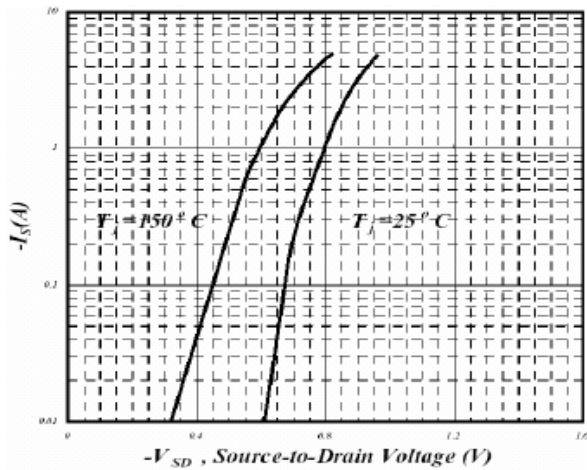

Fig 5. Forward Characteristics of Reverse Diode

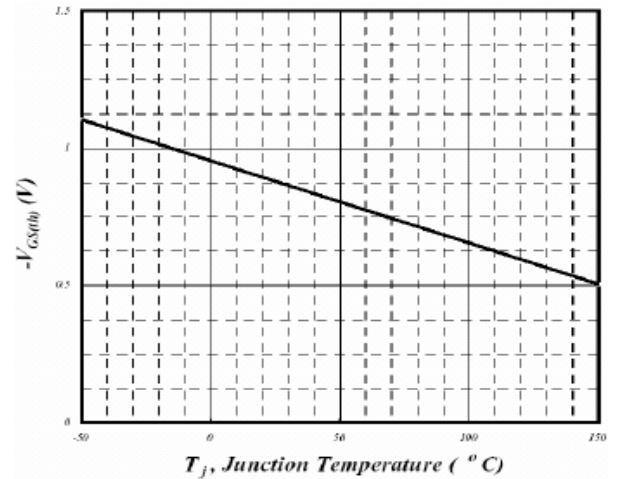

Fig 6. Gate Threshold Voltage v.s. Junction Temperature

Characteristic Curves(Cont.)

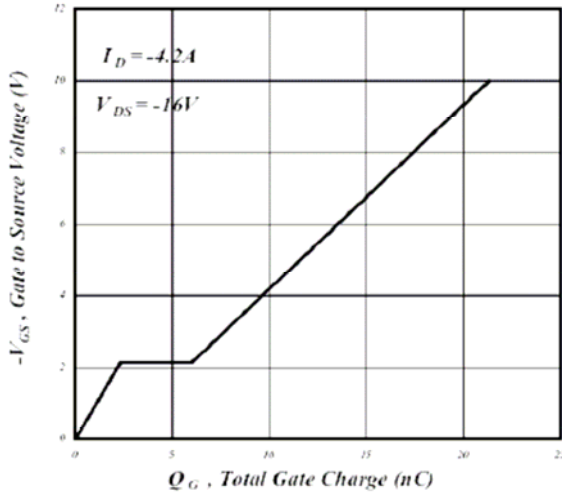

Fig 7. Gate Charge Characteristics

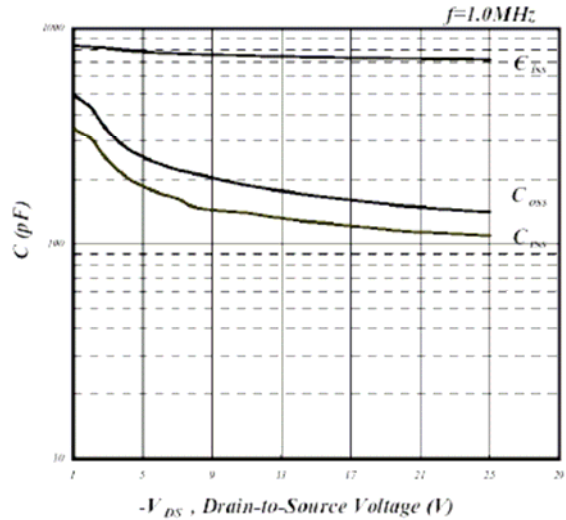

Fig 8. Typical Capacitance Characteristics

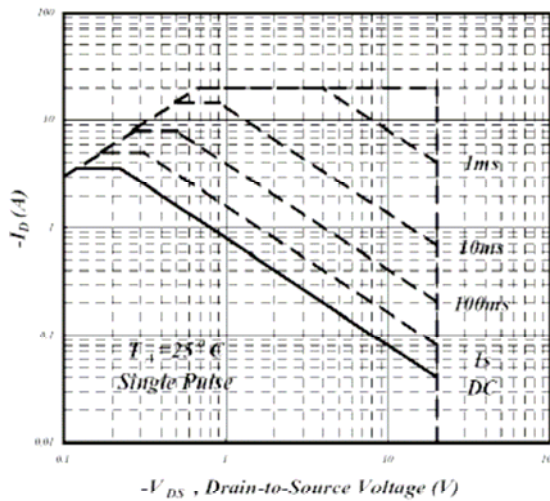

Fig 9. Maximum Safe Operating Area

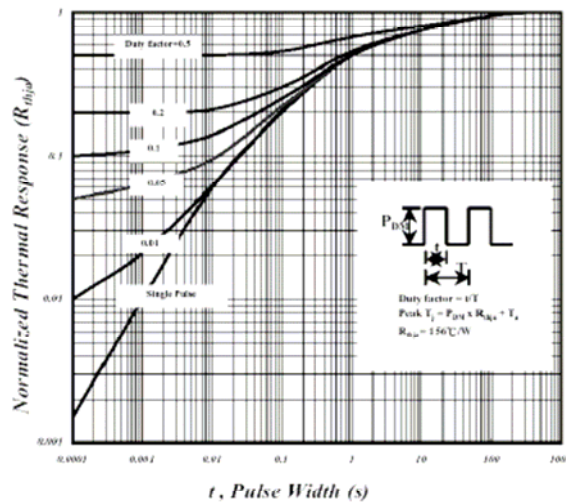

Fig 10. Effective Transient Thermal Impedance

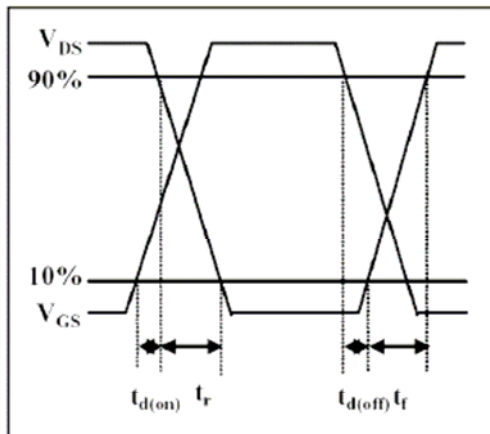

Fig 11. Switching Time Waveform

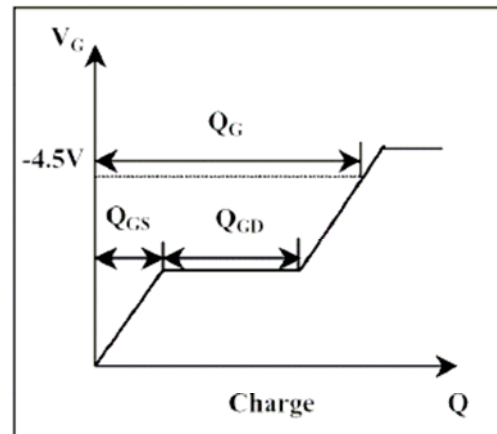
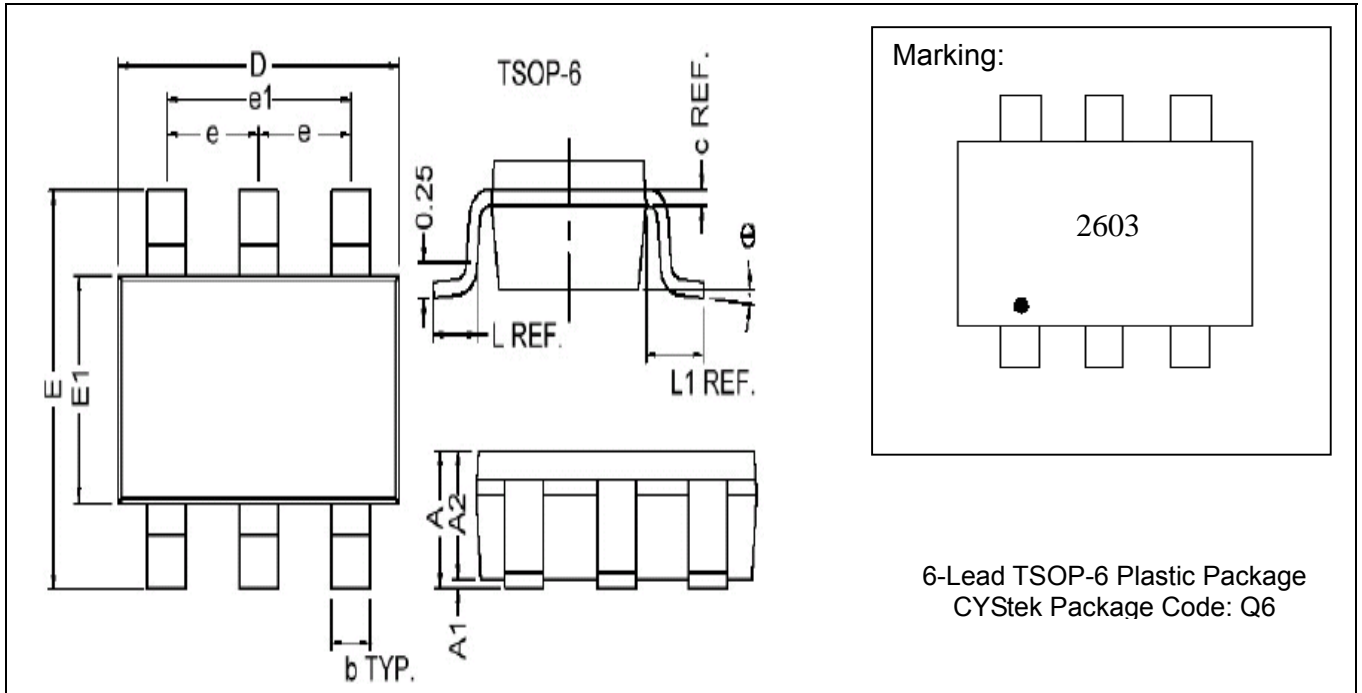

Fig 12. Gate Charge Waveform

TSOP-6 Dimension



*: Typical

DIM	Inches		Millimeters		DIM	Inches		Millimeters	
	Min.	Max.	Min.	Max.		Min.	Max.	Min.	Max.
A	-	0.043	-	1.10	L	0.018 REF		0.45 REF	
A1	0.000	0.004	0.00	0.10	L1	0.024 REF		0.60 REF	
A2	0.028	0.039	0.70	1.00	θ	0°	10°	0°	10°
c	0.005 REF		0.12 REF		b	0.012	0.020	0.30	0.50
D	0.106	0.122	2.70	3.10	e	0.037 REF		0.95 REF	
E	0.102	0.118	2.60	3.00	E1	0.075 REF		1.90 REF	
E1	0.055	0.071	1.40	1.80					

- Notes: 1. Controlling dimension: millimeters.
 2. Maximum lead thickness includes lead finish thickness, and minimum lead thickness is the minimum thickness of base material.
 3. If there is any question with packing specification or packing method, please contact your local CYStek sales office.

Material:

- Lead: 42 Alloy; solder plating
- Mold Compound: Epoxy resin family, flammability solid burning class: UL94V-0

Important Notice:

- All rights are reserved. Reproduction in whole or in part is prohibited without the prior written approval of CYStek.
- CYStek reserves the right to make changes to its products without notice.
- CYStek **semiconductor products are not warranted to be suitable for use in Life-Support Applications, or systems.**
- CYStek assumes no liability for any consequence of customer product design, infringement of patents, or application assistance.