

### Features

- n Operates Over Full AMPS/PCN PCS/PHS Bands
- n Low Conversion Loss
- n Two Hermetic Package Options
- n Typical Midband VSWR 1.5:1
- n High Fundamental and Third Order Suppression

### Description

#### TO-8-1 (FM-108)

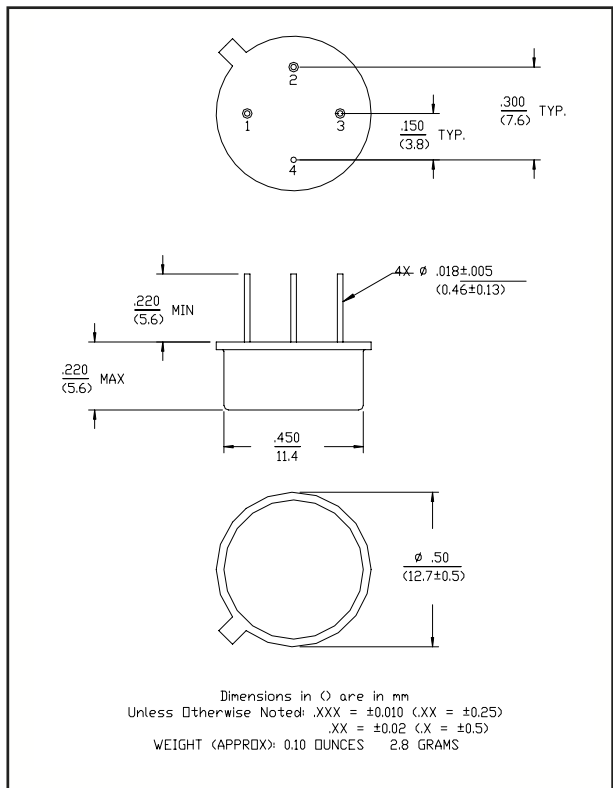

#### FP-2 (FM-107)

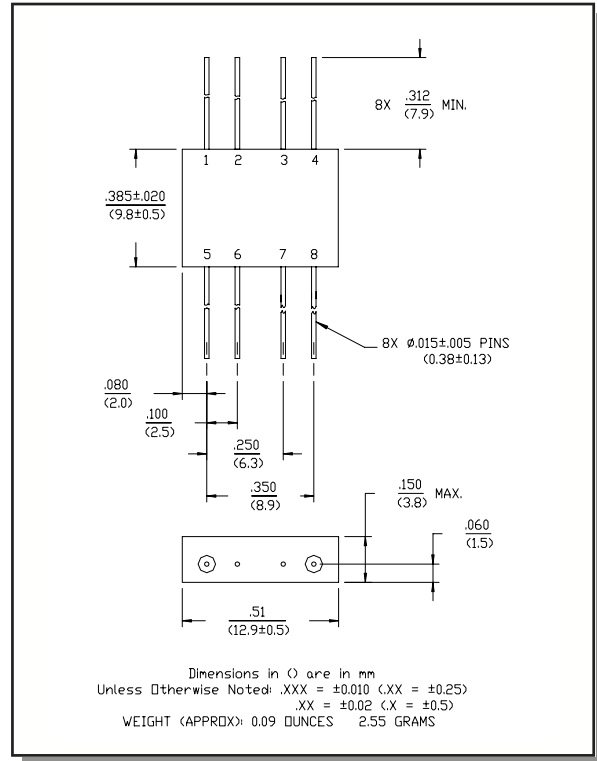

#### SF-1 (FMS-109)

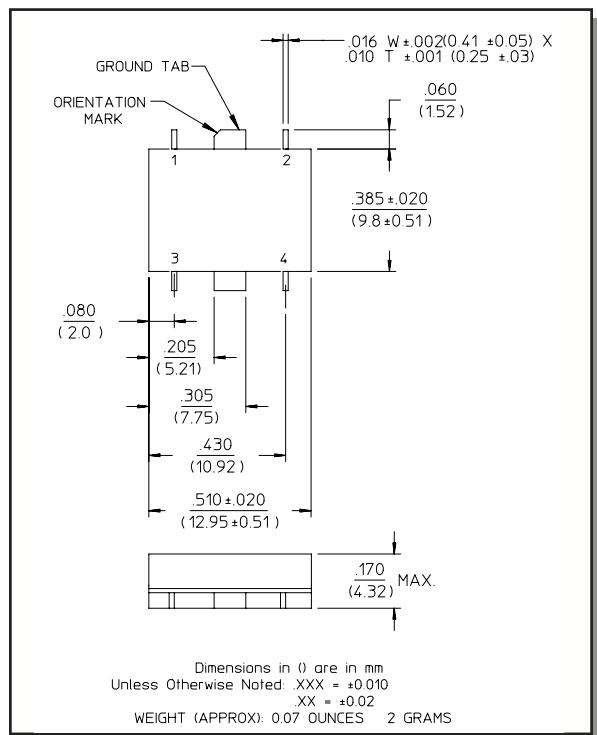

**Electrical Specifications:  $T_A = 25^\circ\text{C}$ , Input Frequency: 5-2400 MHz,  
Output Frequency: 10-4800 MHz, Input Power: +10 dBm**

Parameter	Test Conditions	Frequency	Units	Min.	Typ.	Max.
Conversion Loss	Input: +10 dBm		dB	—	11	13
F1 Suppression	Input: +10 dBm	5-750 MHz	dB	30	40	—
		750-1000 MHz	dB	25	30	—
		1000-2400 MHz	dB	20	25	—
F3 Suppression	Input: +10 dBm	15-1500 MHz	dB	35	40	—
		1500-3000 MHz	dB	25	35	—
		3000-7200 MHz	dB	20	25	—
VSWR	Input: +10 dBm		Ratio	—	1.5:1	2.0:1
Loss as Quadrupler	Input: +10 dBm		dB	—	27	—

## Pin Configuration (FM-107)

Pin No.	Function	Pin No.	Function
1	GND	5	GND
2	GND	6	GND
3	GND	7	GND
4	RF IN	8	RF OUT

## Pin Configuration (FM-108)

Pin No.	Function	Pin No.	Function
1	RF IN	3	RF OUT
2	N/C	4	GND

## Pin Configuration (FMS-109)

Pin No.	Function	Pin No.	Function
1	GND	3	GND
2	RF OUT	4	RF IN

## Absolute Maximum Ratings <sup>1</sup>

Parameter	Absolute Maximum
Max Input Power <sup>2</sup>	
Total Power	300 mW Max. Derated to 85°C @ 3.2 mW/°C

1. Operation of this device above any one of these parameters may cause permanent damage.
2. Ambient Temperature ( $T_A$ ) = +25°C

## Typical Performance Curves

**Conversion Loss vs. Input Freq.**

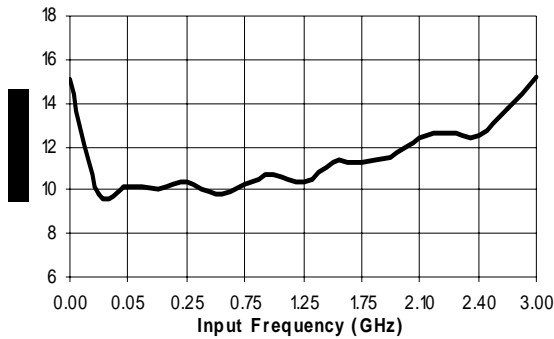

**Spurious Response: F3 Suppression**

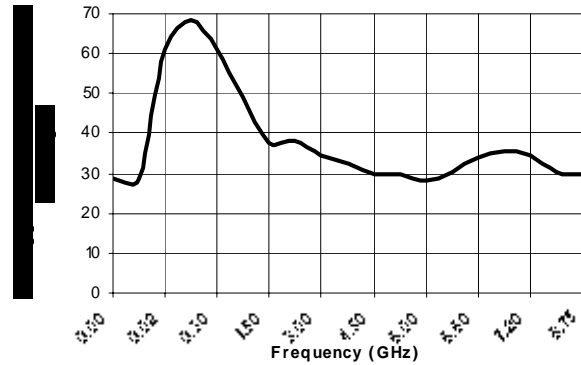

**Spurious Response: F1 Suppression**

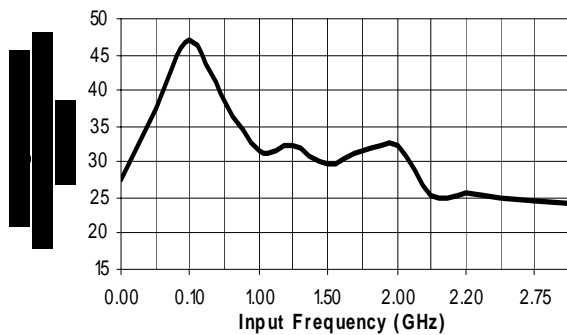

**Loss as a Quadrupler**

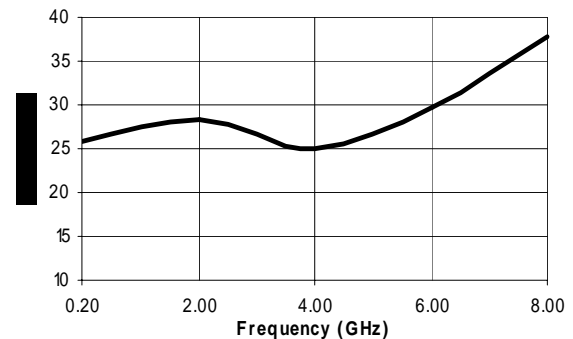

## Ordering Information

Part Number	Package
FM-107-PIN	Hermetic Flatpack Package (FP-2)
FM-108-PIN	Hermetic Package (TO-8-1)
FMS-109-PIN	Hermetic Surface Mount package (SF-1)