

## Small-sized Class-D Speaker Amplifiers

# Analog Input

# Stereo Class-D Speaker Amplifier

**BD5471MUV**

No.10101EAT03

**●Description**

BD5471MUV is a low voltage drive class-D stereo speaker amplifier that was developed for note-book PC, cellular phone, mobile audio products and the others. LC filters of speaker outputs are unnecessary, and only 7 external components are needed for speaker system. Also, 3.3V regulator in BD5471MUV can use power supply for audio-codec. BD5471MUV, that is high-efficiency, low consumption, is suitable for application by using battery. Shutdown current is 0μA typically. Also, start-up time is fast from shutdown to active mode. BD5471MUV can use for some applications that change mode between "shutdown state" and "active state".

**●Features**

- 1) High power 2.3W typ. (VDD=5V, RL=4Ω, THD+N=10%, stereo input)  
High power 1.5W typ. (VDD=5V, RL=8Ω, THD+N=10%, stereo input)
- 2) Gain selectable by the external control (6, 12, 18, 24dB)
- 3) Pop noise suppression circuitry
- 4) Standby function (Mute function) [I<sub>SD</sub>=0μA]
- 5) Protection circuitry (Short protection [Audio, REG], Thermal shutdown, Under voltage lockout)
- 6) Built-in 3.3V regulator
- 7) Built-in BEEP detect circuitry
- 8) Very small package VQFN024V4040

**●Applications**

Notebook computers, Mobile electronic applications, Mobile phones, PDA etc.

**●Absolute Maximum Ratings (Ta=+25°C)**

Parameter	Symbol	Ratings	Unit
Power Supply Voltage	VDD	7.0	V
Power Dissipation	Pd	0.7 *1	W
		2.2 *2	W
Storage Temperature Range	Tstg	-55 ~ +150	°C
Input Voltage Range *3	Vin	-0.3 ~ VDD+0.3	V
Control Terminal Input Voltage Range *4	Vctl	-0.3 ~ VDD+0.3	V

\*1 74.2mm × 74.2mm × 1.6mm, FR4 1-layer glass epoxy board (Copper on top layer 0%)

Derating in done at 5.6mW/°C for operating above Ta=25°C. There are thermal via on the board

\*2 4.2mm × 74.2mm × 1.6mm, FR4 4-layer glass epoxy board (Copper on bottom 2 and 3 layer 100%)

\*3 input Terminal (INL+, INL-, INR+, INR-)

\*4 Control Terminal (MUTE, G0, G1, EAPD, BEEP, REG\_SD)

**●Operating Conditions**

Parameter	Symbol	Ratings	Unit
Power Supply Voltage	VDD	+4.5 ~ +5.5	V
Temperature Range	Topr	-40 ~ +85	°C

\* These products aren't designed for protection against radioactive rays.

●Electric Characteristics(Unless otherwise specified, Ta=+25°C, VDD=+5.0V, RL=8Ω, AC item= LC Filter(L=22μH, C=1μF) )

Parameter	Symbol	Limits			Unit	Conditions
		MIN.	TYP.	MAX.		
Circuit current (Active)	I <sub>CC</sub>	—	5.5	12.0	mA	Active mode, MUTE=H, EAPD=H, No load
Circuit current (Standby)	I <sub>STBY</sub>	—	0.1	1.0	mA	Standby mode, MUTE=H, EAPD=L
Circuit current (Regulator)	I <sub>CCR</sub>	—	0.15	1.0	mA	Regulator Mode, MUTE=EAPD=L, REG_SD=H
Circuit current (Shutdown)	I <sub>SD</sub>	—	0.1	2.0	μA	Shutdown mode, MUTE=L, REG_SD=L
<Speaker Amplifier>						
Output power 1	P <sub>O1</sub>	0.8	1.2	—	W	BTL, f=1kHz, THD+N=1%, Stereo input, *1, *2
Output power 2	P <sub>O2</sub>	1.0	1.5	—	W	BTL, f=1kHz, THD+N=10%, Stereo input, *1, *2
Voltage gain	GV	5.5	6.0	6.5	dB	BTL, G0=G1=GND
		11.5	12	12.5	dB	BTL, G0=GND, G1=VDD
		17.5	18	18.5	dB	BTL, G0=VDD, G1=GND
		23.5	24	24.5	dB	BTL, G0=G1=VDD
Total harmonic distortion	THD+N	—	0.2	1.0	%	BTL, Po=0.7*P <sub>O1</sub> *1, *2
Crosstalk	C <sub>T</sub>	60	70	—	dB	BTL, f=1kHz *1, *3
S/N	SNR	70	90	—	dB	BTL, Po=P <sub>O1</sub> *1, *3
Switching Frequency	f <sub>osc</sub>	175	250	325	kHz	
Start-up time	T <sub>on</sub>	0.78	1.02	1.46	msec	
Input resistance	R <sub>IN</sub>	63	90	117	kΩ	G0=G1=GND
		42	60	78	kΩ	G0=GND, G1=VDD
		25	36	47	kΩ	G0=VDD, G1=GND
		14	20	26	kΩ	G0=G1=VDD
<Regulator>						
Output voltage	V <sub>o</sub>	3.15	3.30	3.45	V	I <sub>o</sub> =150mA
Maximum output current	I <sub>om</sub>	150	200	—	mA	V <sub>o</sub> =3.15V
Load regulation	L <sub>REG</sub>	—	0.2	1	mV/mA	I <sub>o</sub> =0→150mA
<Control terminal (MUTE, G0, G1, EAPD, BEEP, REG_SD) >						
Control terminal input voltage	High-level	V <sub>CTLH</sub>	1.4	—	VDD	V
	Low-level	V <sub>CTL</sub>	0	—	0.4	V
Control terminal input current	I <sub>CTL</sub>	22	33	44	μA	Control terminal Input voltage V <sub>CTL</sub> =5V

\*1: B.W.=400 ~ 30kHz, BTL: The voltage between 3pin and 6pin, 13pin and 16pin

●Active / Standby Control

Mode	Pin level	Conditions
MUTE	H/L	IC active/ shutdown
EAPD	H/L	IC active/standby
BEEP	H/L	IC active/standby
REG_SD	H/L	REG active/shutdown

● Measurement Circuit Diagram

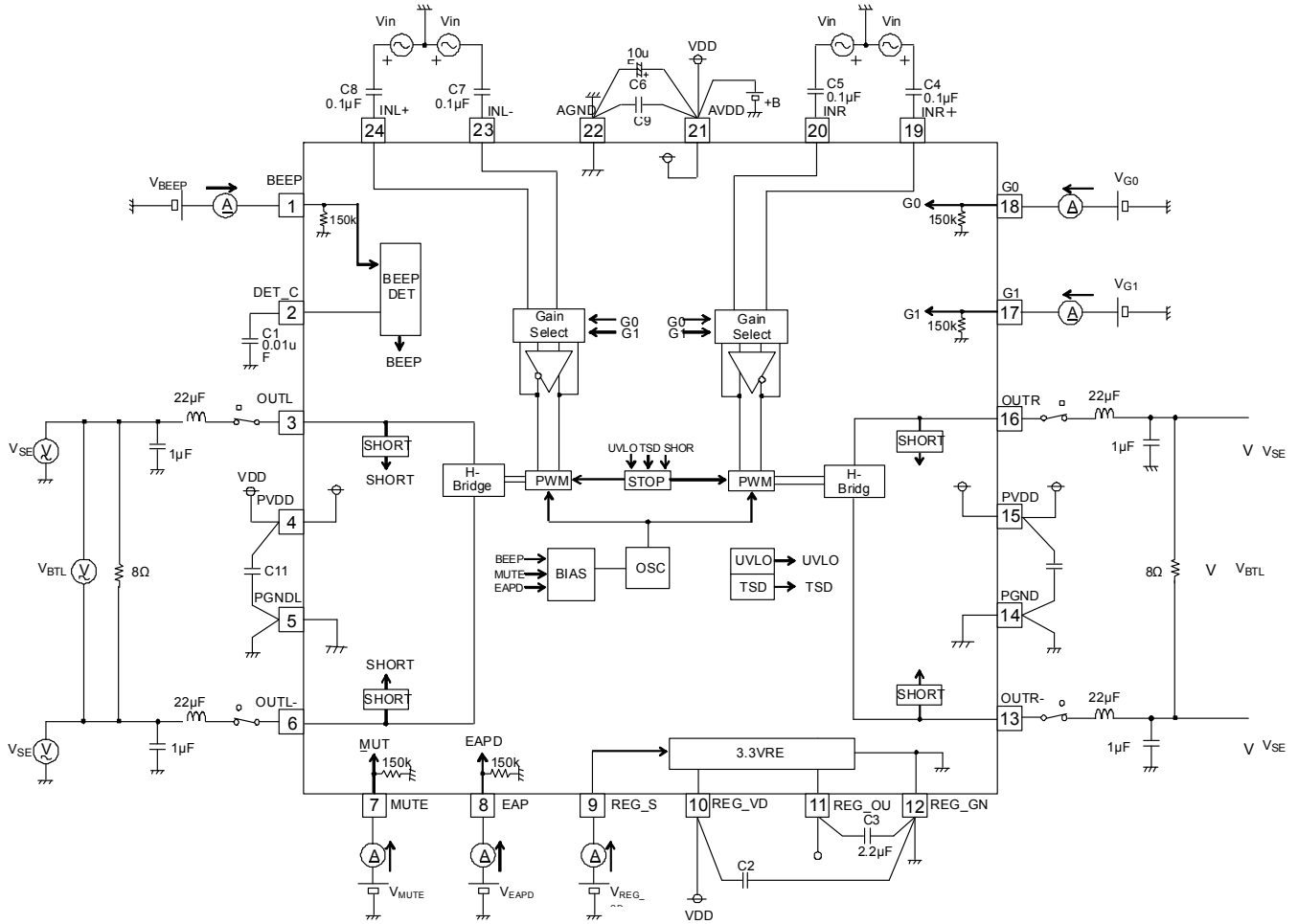

● Package Outlines

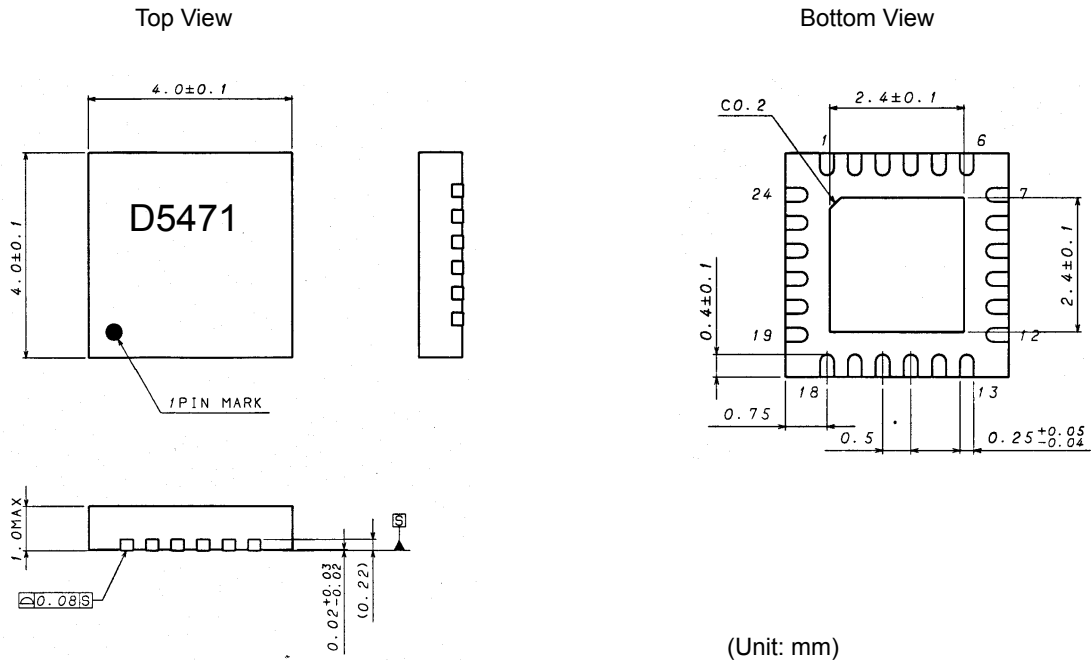

VQFN024V4040 (Plastic Mold)

●Block Diagram

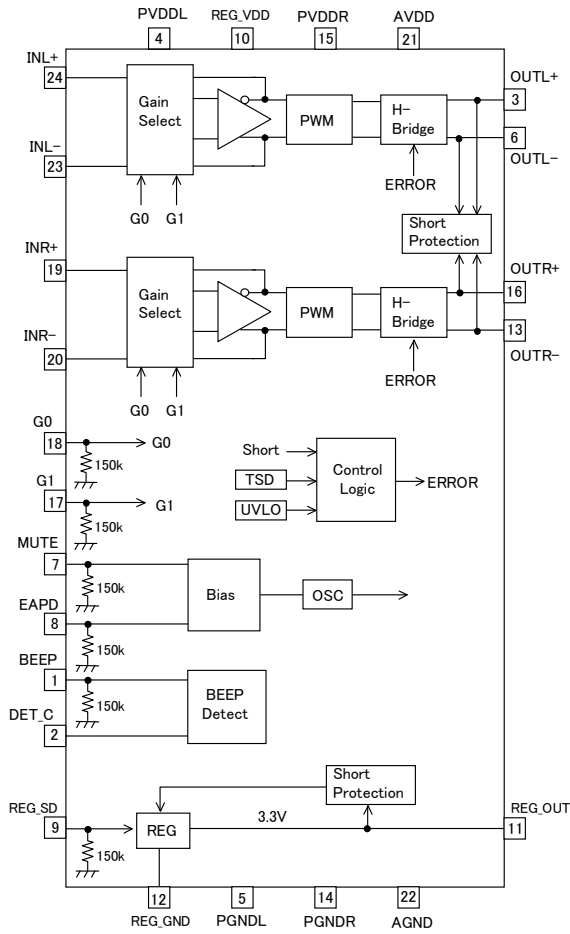

●Pin Assignment <top view>

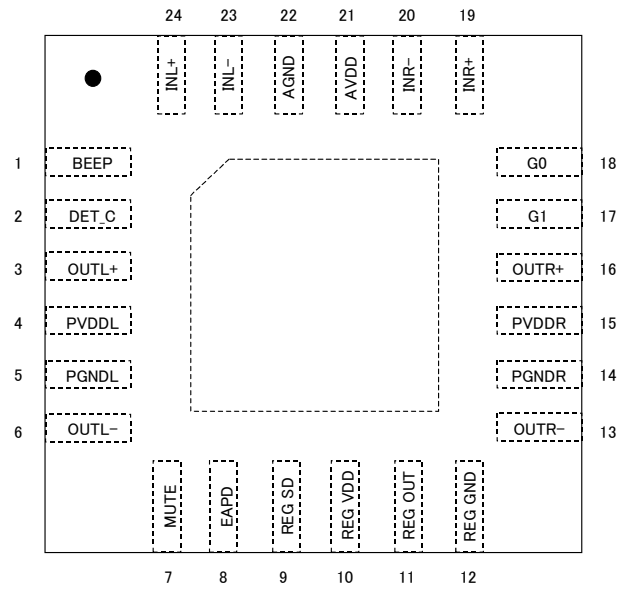

●Pin Assignment Table

PIN No.	PIN Name
1	BEEP
2	DET_C
3	OUTL+
4	PVDDL
5	PGNDL
6	OUTL-
7	MUTE
8	EAPD
9	REG_SD
10	REG_VDD
11	REG_OUT
12	REG_GND
13	OUTR-
14	PGNDR
15	PVDDR
16	OUTR+
17	G1
18	G0
19	INR+
20	INR-
21	AVDD
22	AGND
23	INL-
24	INL+

● Application Circuit Example

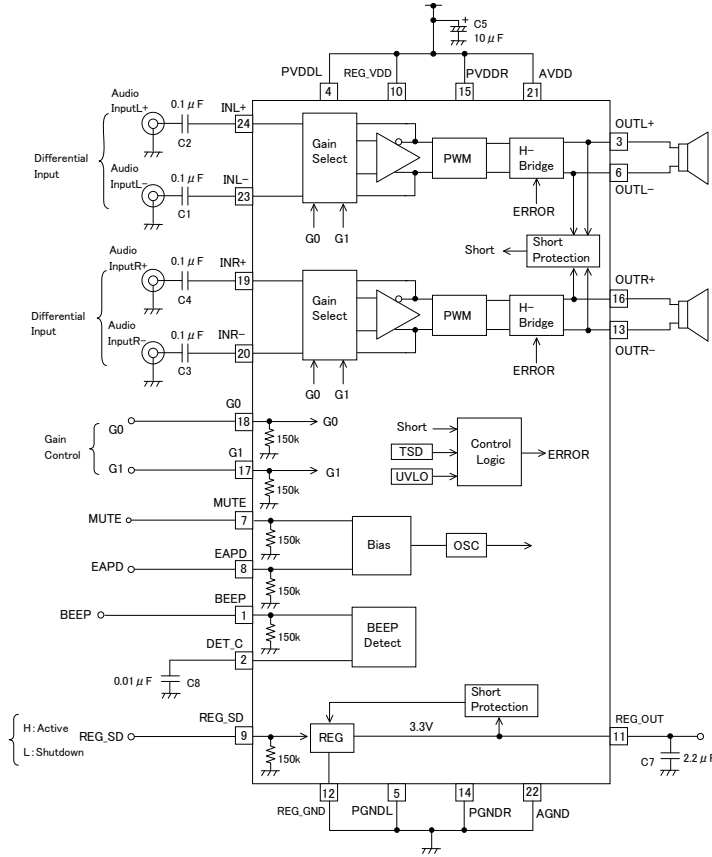

Differential input

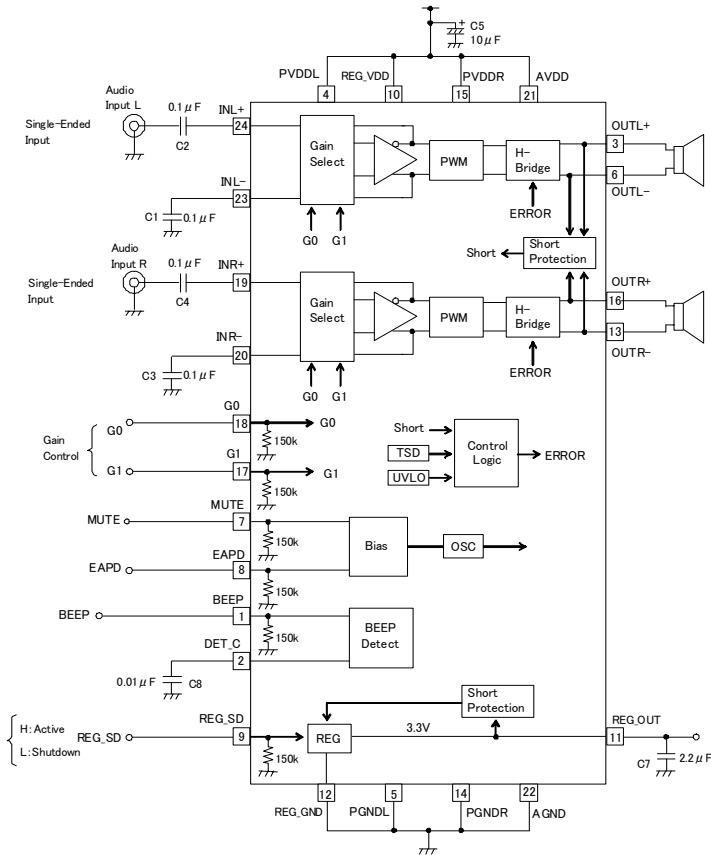

Single-Ended input

●Evaluation board Circuit Diagram

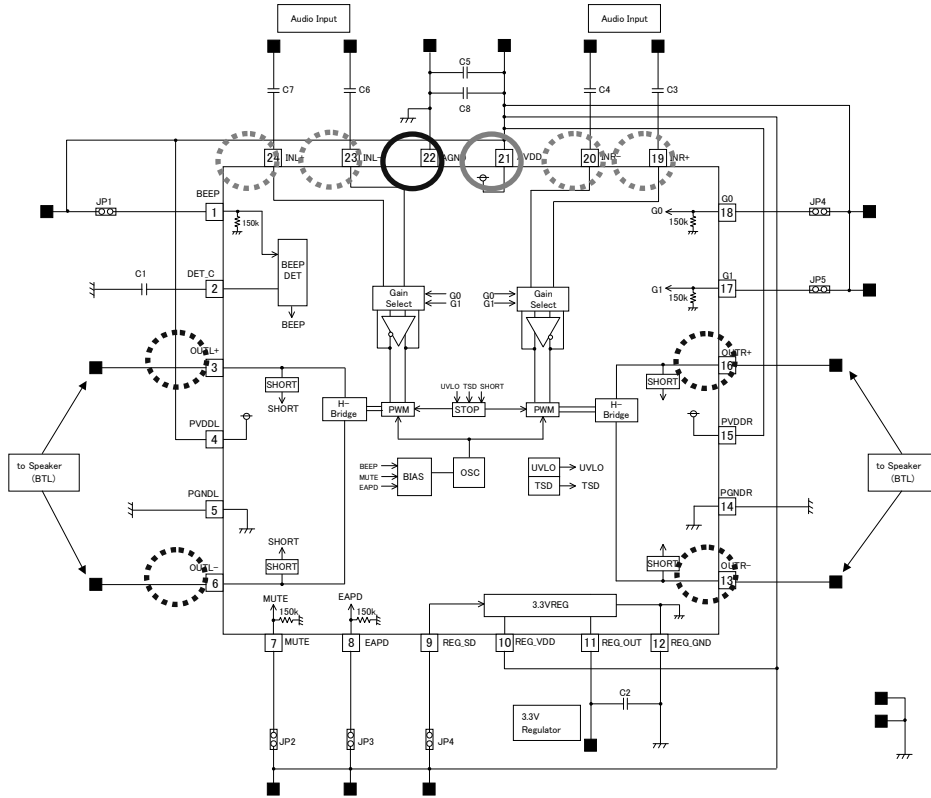

- Please connect to Input Signal line.
- Please connect to Power Supply (VDD=+2.5~5.5V) line.
- Please connect to GND line.

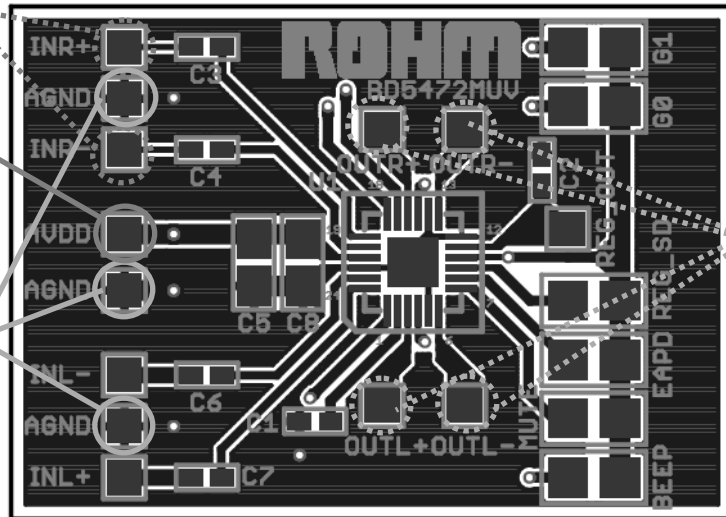

Please connect to Speaker.

### ●Evaluation board Parts List

Qty.	Item	Description	SMD Size	Manufacturer/Part Number
1	C1	Capacitor, 0.01μF	1608	Murata GRM188R71C103KA01D
1	C2	Capacitor, 2.2μF	1608	Murata GRM188R61C225KE15D
2	C3, C4,C6,C7	Capacitor, 0.1μF	1608	Murata GRM188R71C104KA01D
1	C5, C8	Capacitor, 10μF	A (3216)	ROHM TCFGA1A106M8R
1	U1	IC, BD5471MUV, Stereo Class-D audio amplifier	4.0mm X 4.0mm VQFN Package	ROHM BD5471MUV
1	PCB1	Printed-circuit board, BD5471MUV EVM	—	—

### ●The relation in the gain setting and input impedance Ri

The gain setting terminal (G0,G1)

G0	G1	Gain[dB]	Ri [Ohm]
L	L	6	90k
L	H	12	60k
H	L	18	36k
H	H	24	20k

### ●Description of External parts

#### ①Power down timing capacitor (C1)

It's the capacitor which adjusts time from BEEP signal stop to amplifier stop.  
Turn off time  $T_{off}$  is set the following formula.

$$T_{off} = \frac{C1 \times 0.8V_{DD}}{5\mu} [\text{ms}]$$

#### ②Regulator output capacitor(C2)

Output capacitor of 3.3V regulator.  
Use capacitance equal to or more than 1μF.

#### ③Input coupling capacitor Ci (C3,C4, C6,C7)

It makes an Input coupling capacitor 0.1μF.  
Input impedance Ri in each gain setting becomes the above table.  
In 18dB gain setting, it is Ri=36kΩ (Typ.).

It sets cutoff frequency  $f_c$  by the following formula by input coupling capacitor Ci (C3,C4, C6,C7) and input impedance Ri

$$f_c = \frac{1}{2\pi \times Ri \times Ci} [\text{Hz}]$$

In case of Ri=36kΩ, Ci=0.1μF, it becomes  $f_c$ =about 44Hz.

#### ④The power decoupling capacitor (C5,C8)

It makes a power decoupling capacitor 10μF.  
When making capacitance of the power decoupling capacitor small, there is an influence in the Audio characteristic.  
When making small, careful for the Audio characteristic at the actual application.

●Evaluation board PCB layer

Top Layer

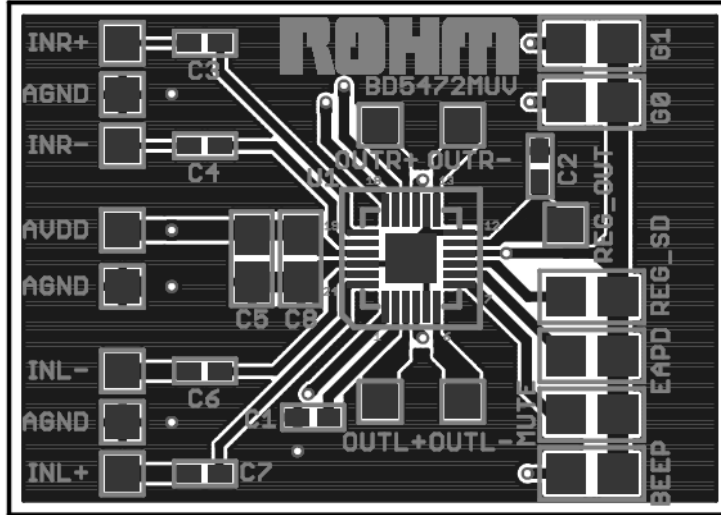

Bottom Layer

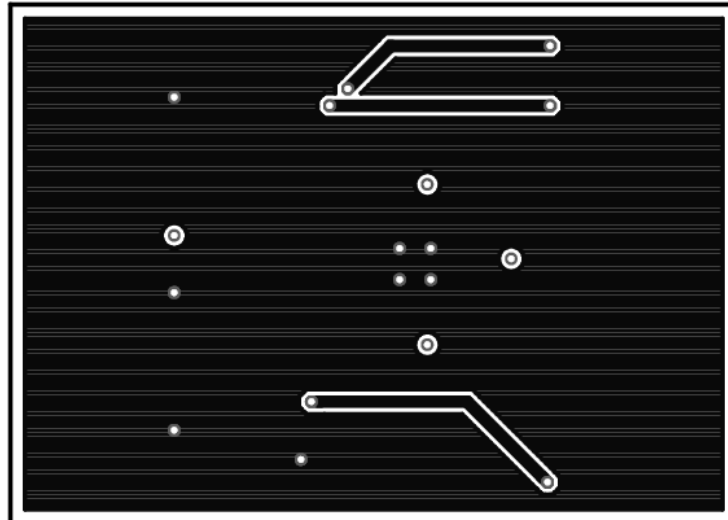



●The way of evaluating Audio characteristics

Evaluation Circuit Diagram

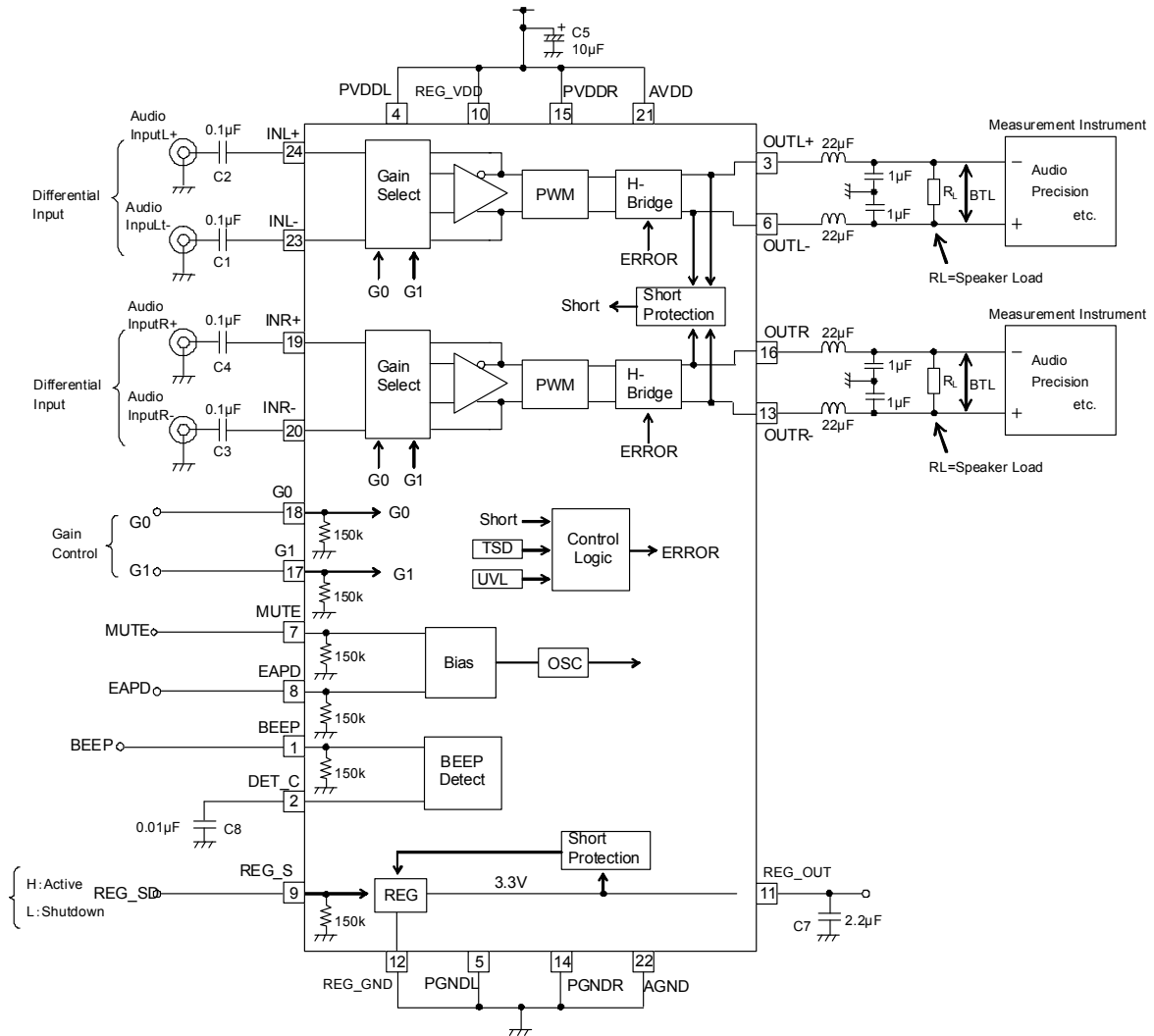

When measuring Audio characteristics, insert LC filter during the output terminal of IC and the speaker load and measure it. Arrange LC filter as close as possible to the output terminal of IC.  
 In case of L=22 µ H, C=1 µ F, the cutoff frequency becomes the following.

$$f_c = \frac{1}{2\pi\sqrt{LC}} \text{ [Hz]}$$

$$=33.9\text{[kHz]}$$

Use a big current type - Inductor L.

(Reference)

TDK: SLF12575T-220M4R0

●BEEP Detection Function

This IC has BEEP detection.

When inputting beep signal to 1pin BEEP terminal at standby mode, amplifier becomes standby to active.

When beep signal stops, amplifier becomes active to standby.

It is adjustable the time(Toff) from beep signal stop to amplifier standby by a capacitance connect to 2pin DET\_C terminal.  
If no need to use BEEP detection, make 1pin BEEP terminal open or connect to GND.

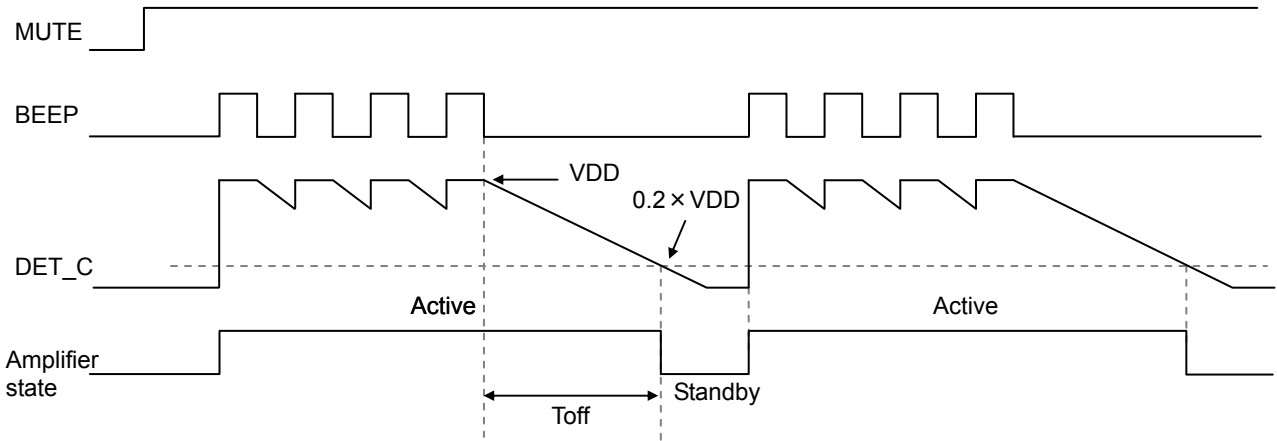

Toff calculation fomula

$$\text{Toff} = \frac{C \times 0.8VDD}{5\mu} \quad [\text{msec}]$$

Example C=0.01u, VDD=5V → Toff=8msec

C: Condenser to connect to a 2pin

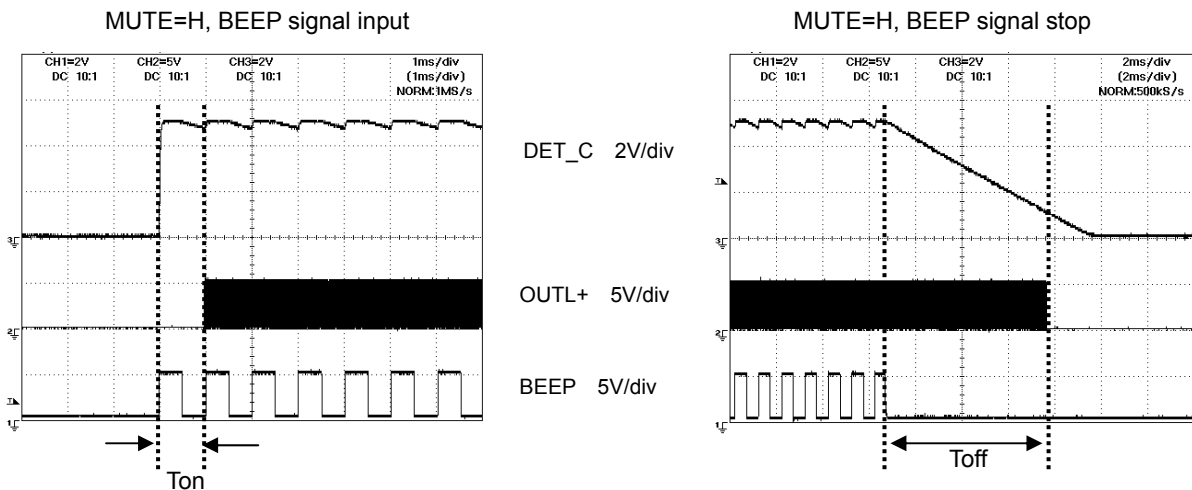

●Control Terminal and output

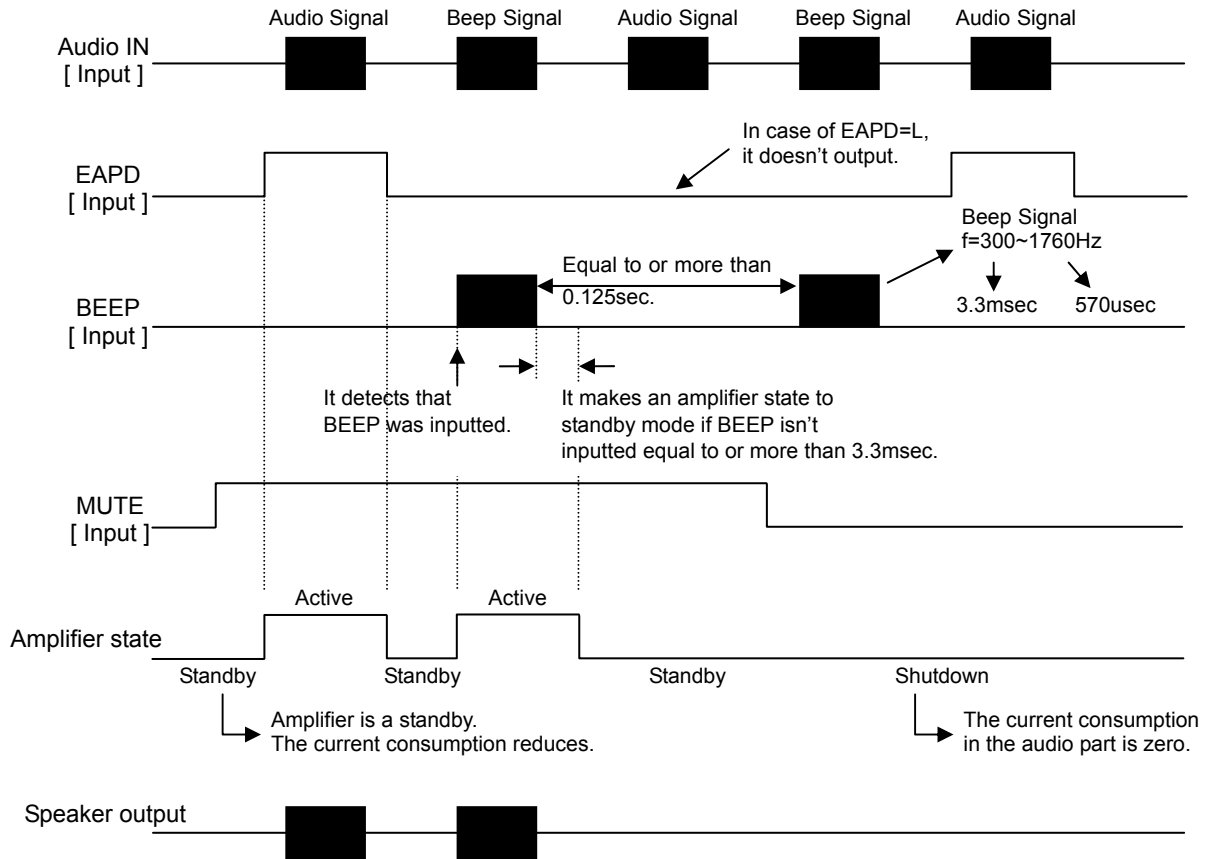

Input				Output	
MUTE	EAPD	BEEP	Audio IN	Amplifier state	Speaker output
L	L	L	No signal	L(Shutdown)	Hiz
L	L	L	signal	L(Shutdown)	Hiz
L	L	H	No signal	L(Shutdown)	Hiz
L	L	H	signal	L(Shutdown)	Hiz
L	H	L	No signal	L(Shutdown)	Hiz
L	H	L	signal	L(Shutdown)	Hiz
L	H	H	No signal	L(Shutdown)	Hiz
L	H	H	signal	L(Shutdown)	Hiz
H	L	L	No signal	L(Standby)	Hiz
H	L	L	signal	L(Standby)	Hiz
H	L	H	No signal	H(Active)	No signal
H	L	H	signal	H(Active)	signal
H	H	L	No signal	H(Active)	No signal
H	H	L	signal	H(Active)	signal
H	H	H	No signal	H(Active)	No signal
H	H	H	signal	H(Active)	signal

●About output starting and stop

This IC has the circuit of pop noise reduction at starting and stop.  
 Pop noise reduction is realized in controlling to adjust the timing of output at starting and stop.  
 Turn on time is 1msec.

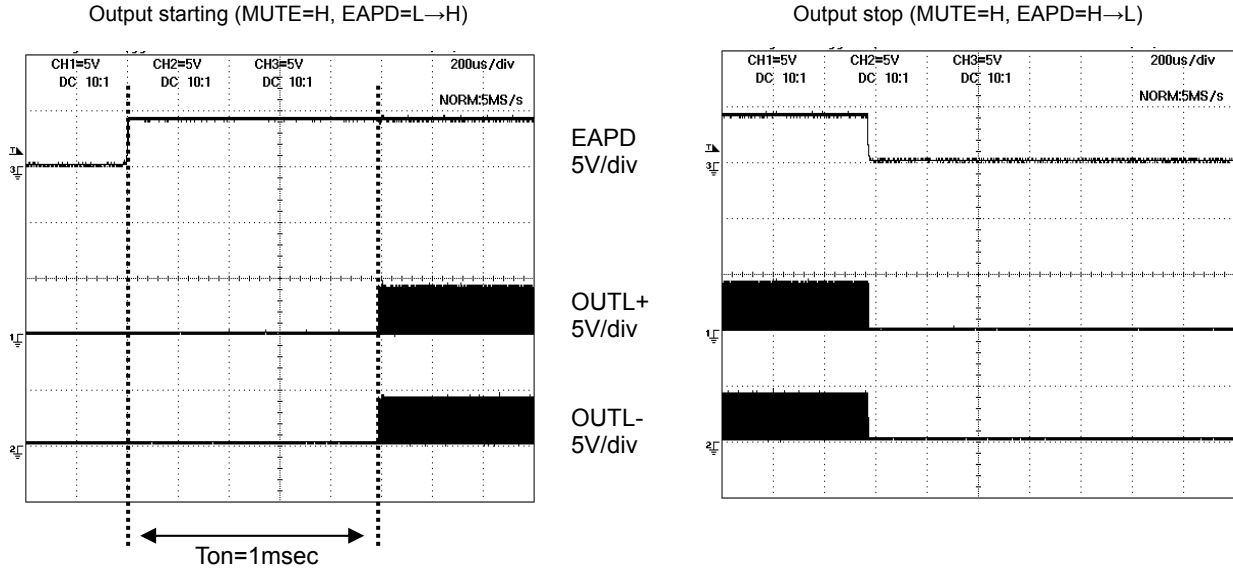

●About the short protection

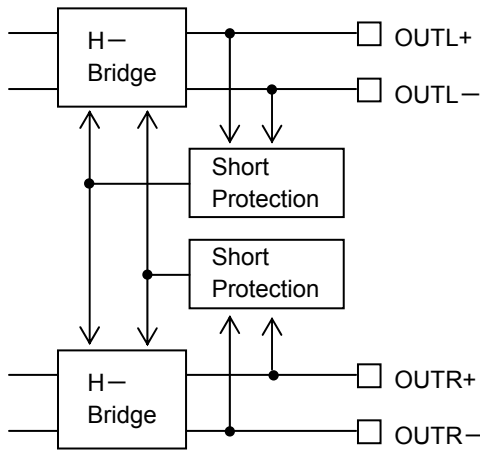

When detecting a short of Lch output, Lch output stops, and Rch output stops.  
 Also when detecting a short of Rch output, Rch output stops, and Lch output stops.

●About the thermal design by the IC

Characteristics of an IC have a great deal to do with the temperature at which it is used, and exceeding absolute maximum ratings may degrade and destroy elements. Careful consideration must be given to the heat of the IC from the two standpoints of immediate damage and long-term reliability of operation. Pay attention to points such as the following. Since an maximum junction temperature ( $T_{JMAX.}$ ) or operating temperature range ( $Topr$ ) is shown in the absolute maximum ratings of the IC, to reference the value, find it using the Pd-Ta characteristic (temperature derating curve). If an input signal is too great when there is insufficient radiation, TSD (thermal shutdown) may operate. TSD, which operates at a chip temperature of approximately +180°C, is canceled when this goes below approximately +100°C. Since TSD operates persistently with the purpose of preventing chip damage, be aware that long-term use in the vicinity that TSD affects decrease IC reliability.

Temperature Derating Curve

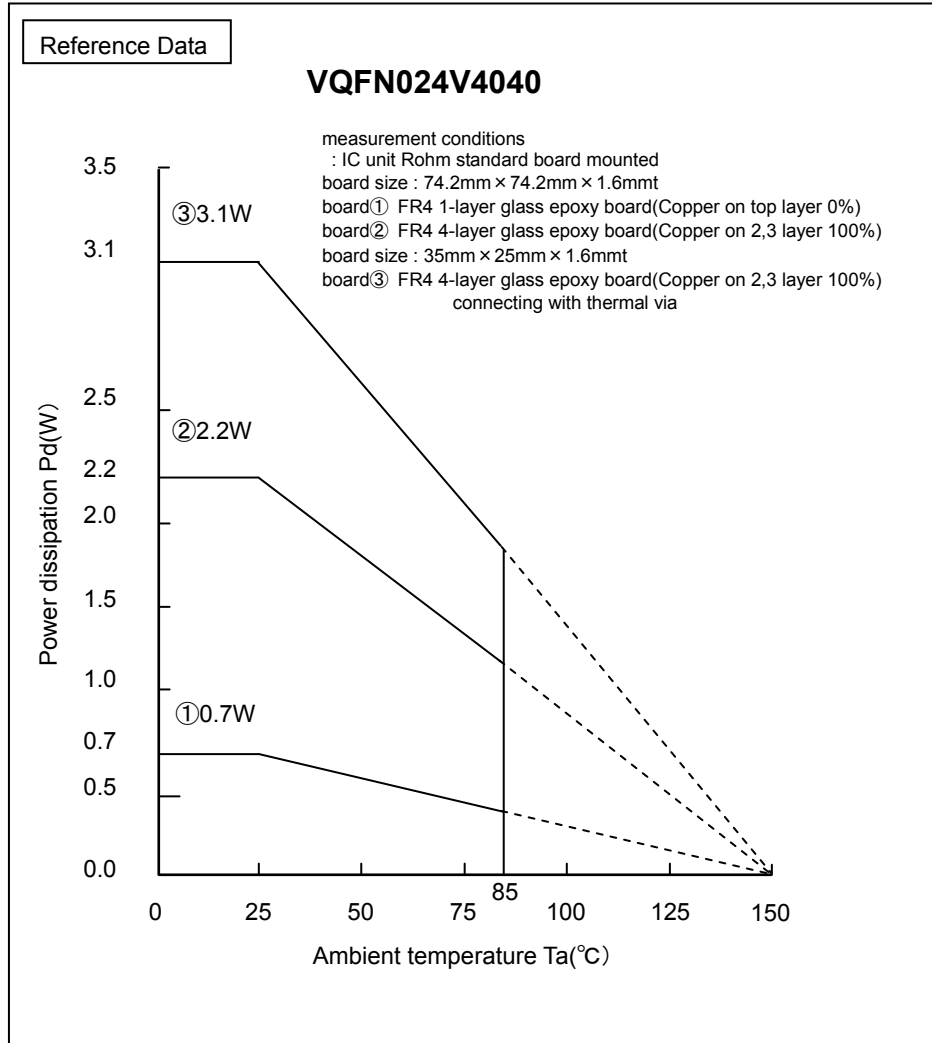

Note) Values are actual measurements and are not guaranteed.

Power dissipation values vary according to the board on which the IC is mounted. The Power dissipation of this IC when mounted on a multilayer board designed to radiate is greater than the values in the graph above.

● Typical Characteristics

TABLE OF GRAPHS

Parameter	Parameter	Figure
Efficiency	vs Output power	1, 2
Power dissipation	vs Output power	3, 4
Supply current (I <sub>ccact</sub> )	vs Supply voltage	5
Supply current (I <sub>stby</sub> )	vs Supply voltage	6
Supply current (I <sub>reg</sub> )	vs Supply voltage	7
Shutdown current (I <sub>sd</sub> )	vs Supply voltage	8
Output power (P <sub>o</sub> )	vs Load resistance	9, 10
	vs Supply voltage	11, 12
Total harmonic distortion plus noise (THD+N)	vs Output power	13, 14
	vs Frequency	15, 16, 17, 18, 19, 20, 21, 22
	vs Common-mode input voltage	23, 24
Supply voltage rejection ratio (PSRR)	vs Frequency	25, 26, 27, 28
Common-mode rejection ratio (CMRR)	vs Frequency	29, 30
Gain	vs Frequency	31, 32, 33, 34, 35, 36, 37, 38

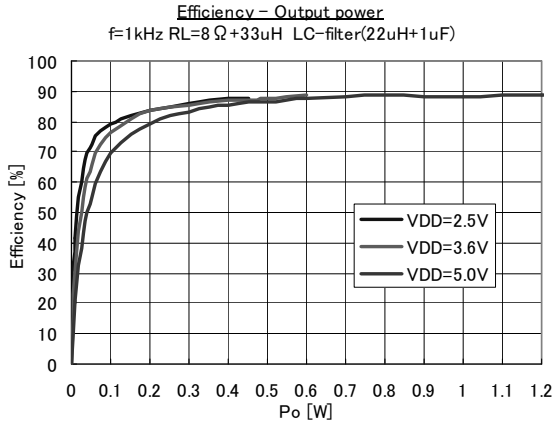

Fig.1

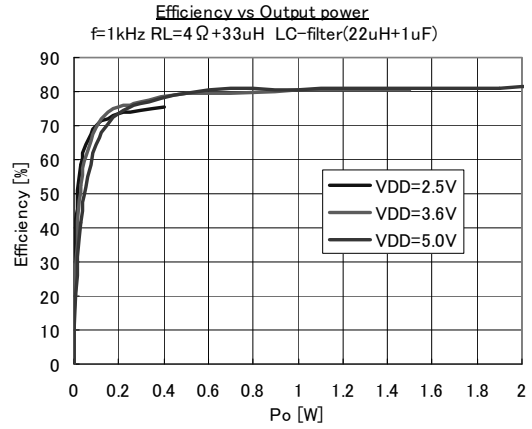

Fig.2

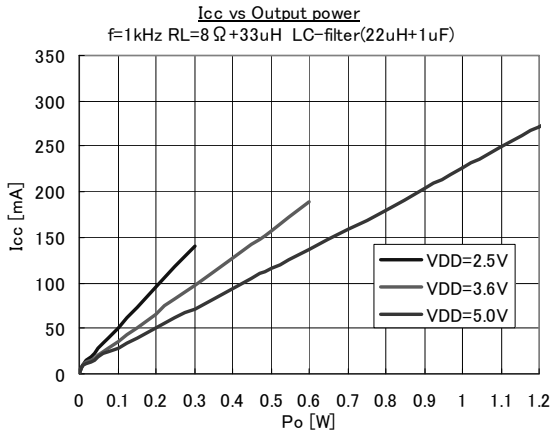

Fig.3

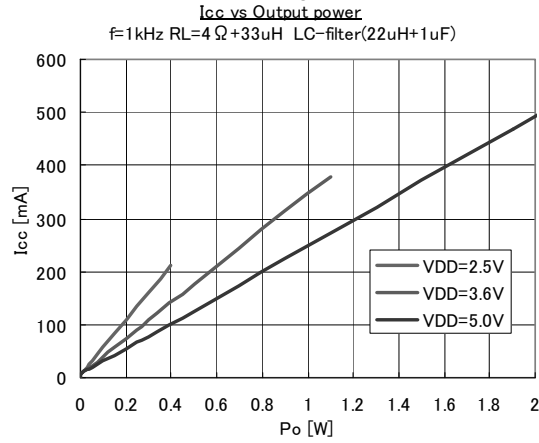

Fig.4

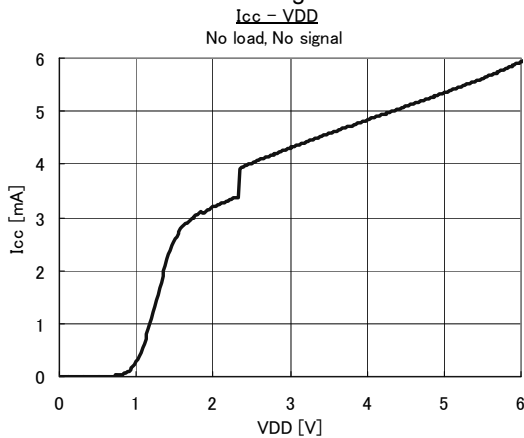

Fig.5

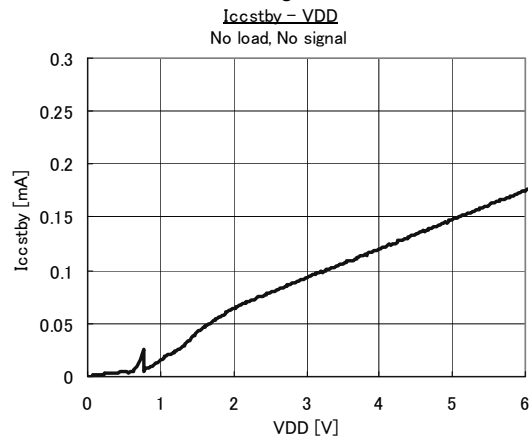

Fig.6

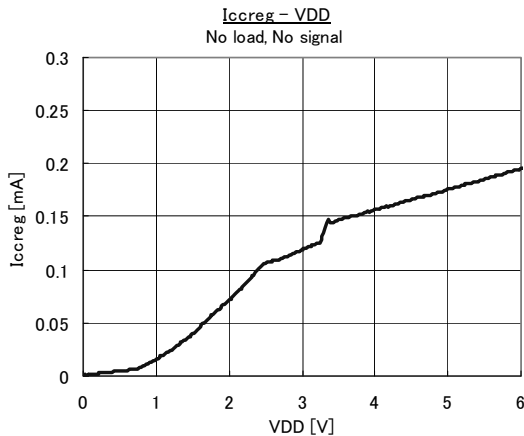

Fig.7

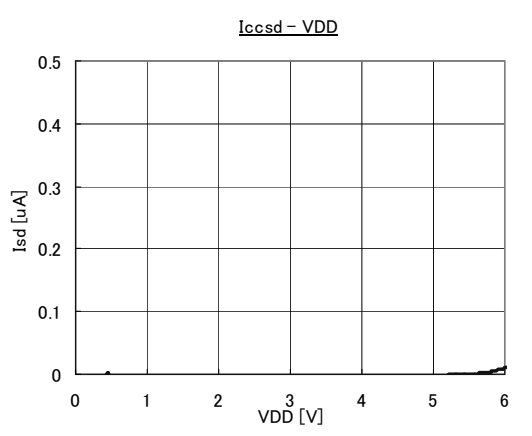

Fig.8

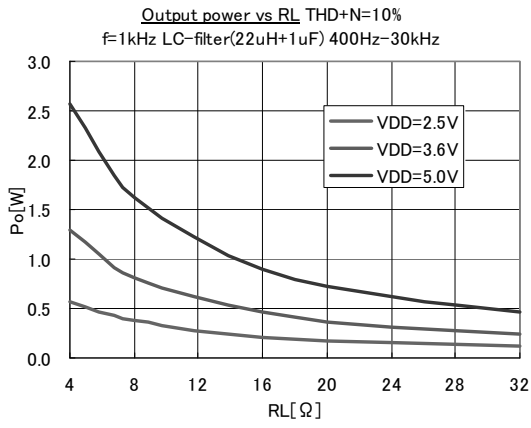

Fig.9

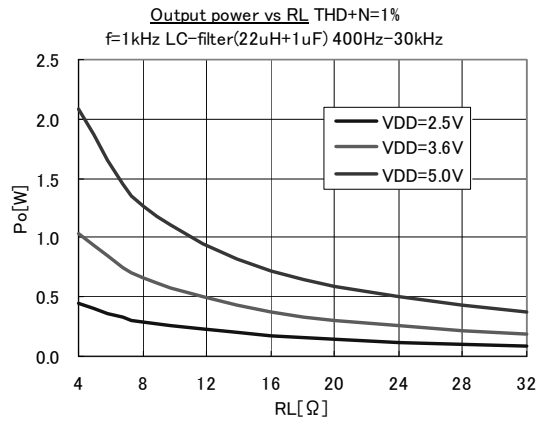

Fig.10

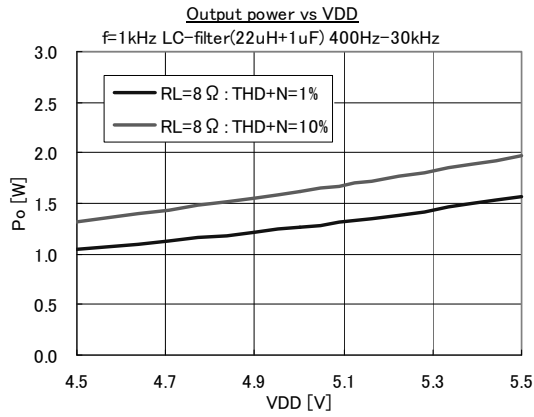

Fig.11

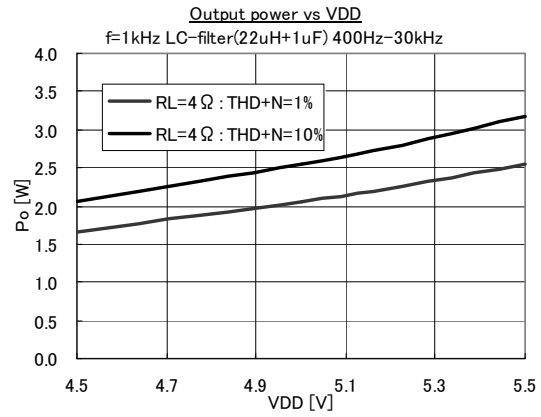

Fig.12

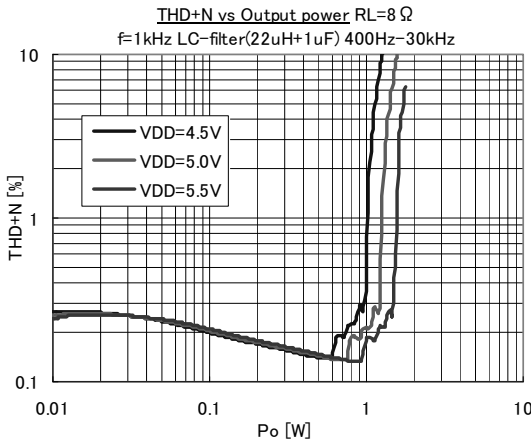

Fig.13

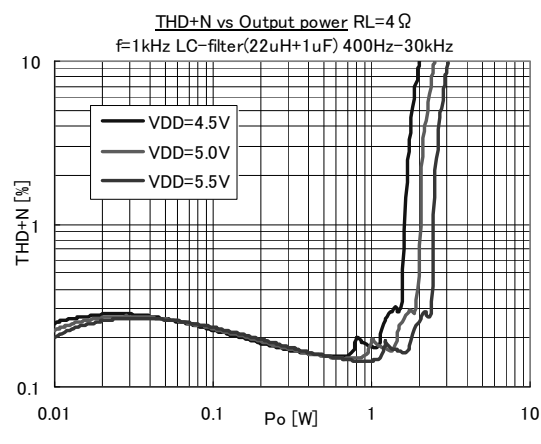

Fig.14

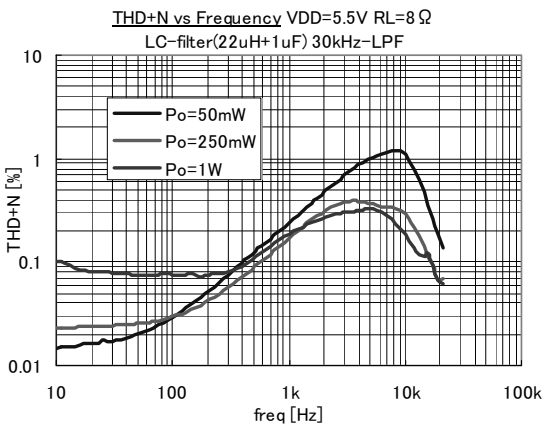

Fig.15

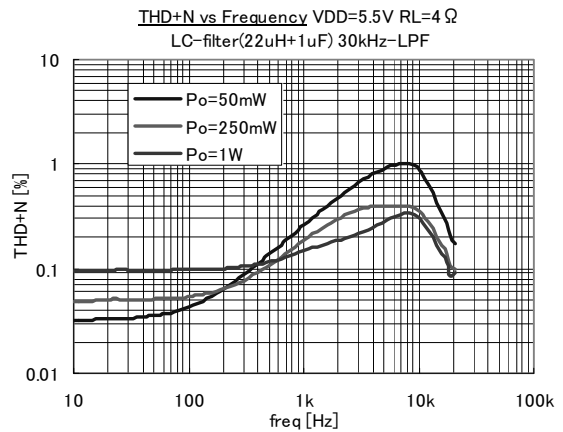

Fig.16



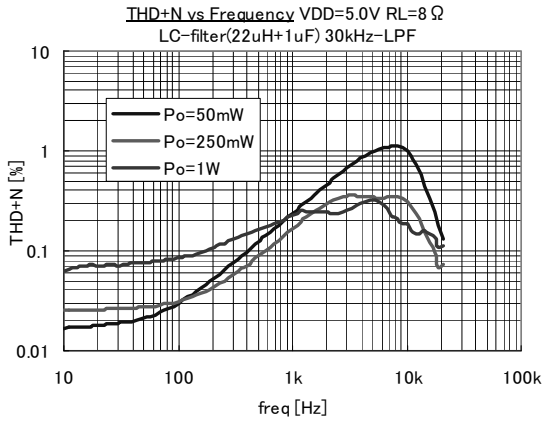

Fig. 17

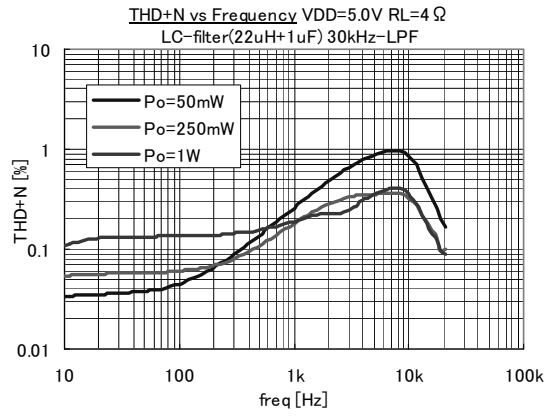

Fig. 18

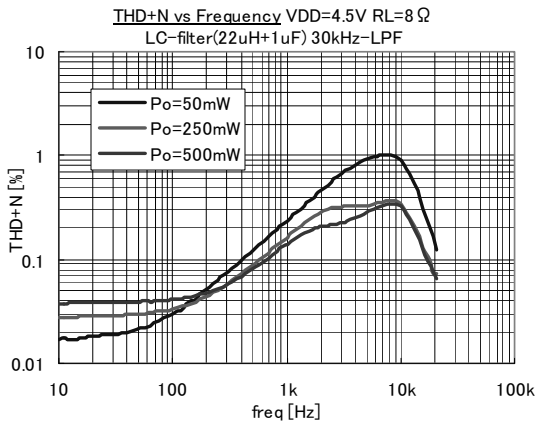

Fig. 19

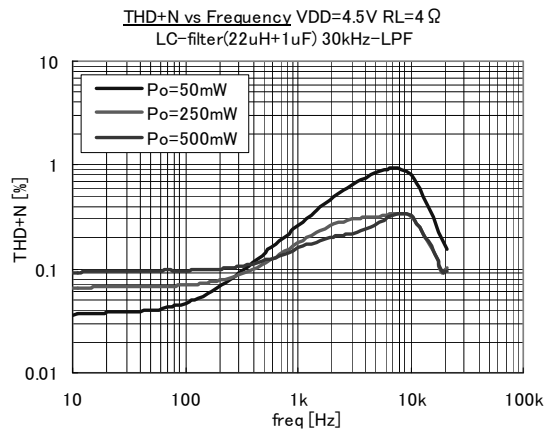

Fig. 20

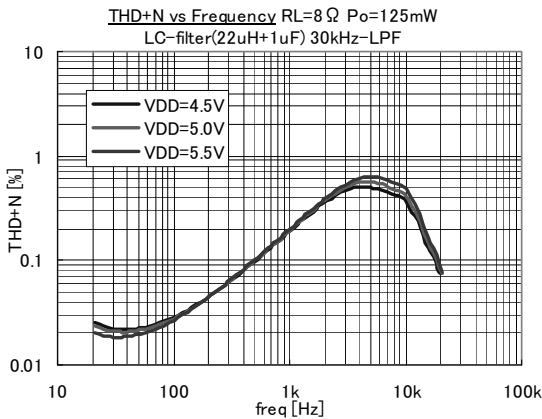

Fig. 21

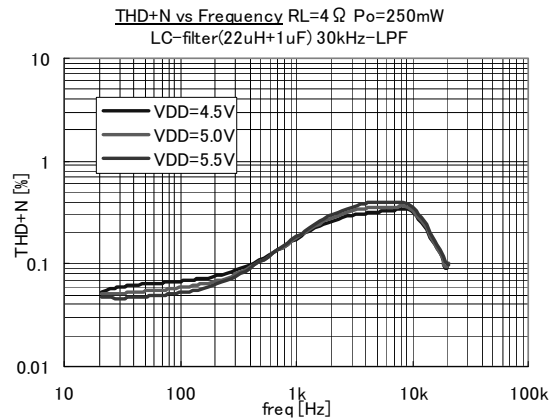

Fig. 22

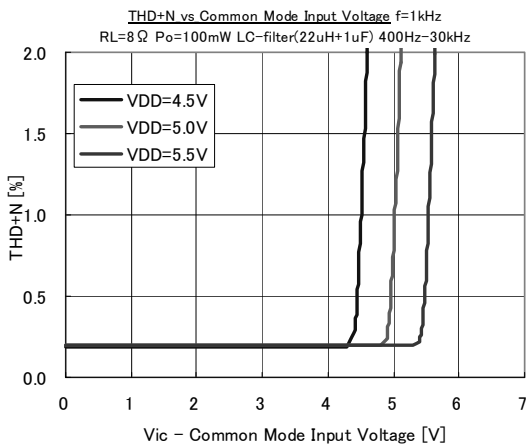

Fig. 23

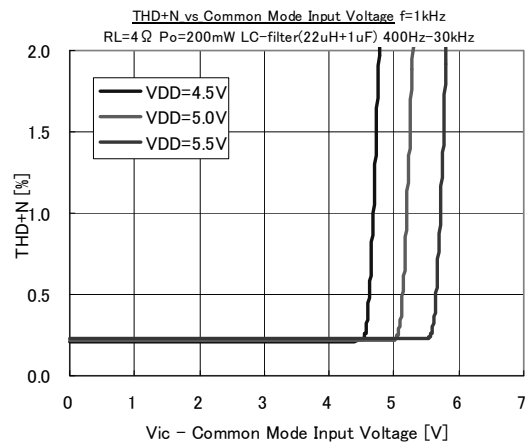

Fig. 24

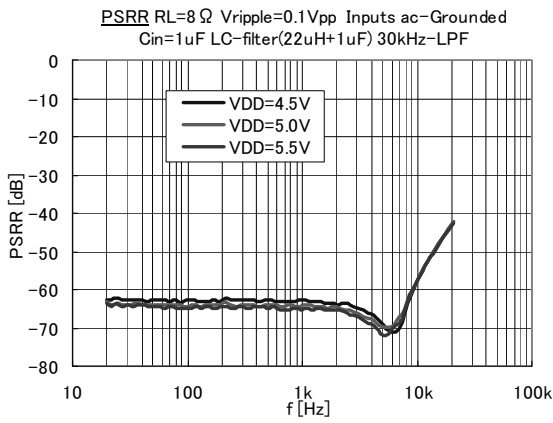

Fig.25

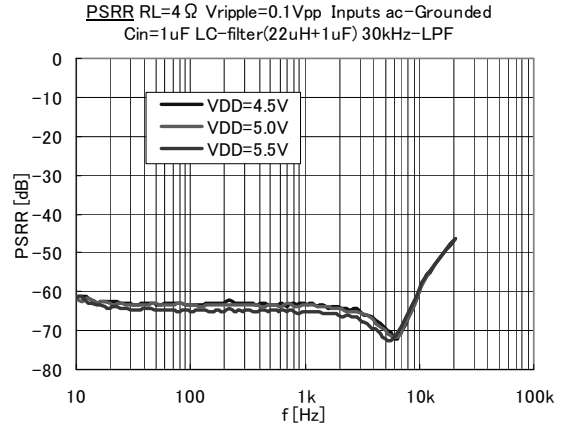

Fig.26

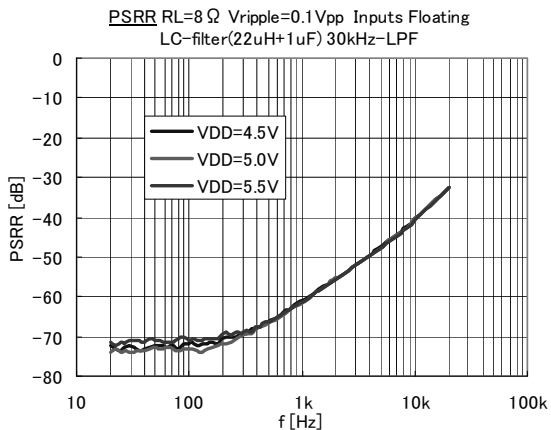

Fig.27

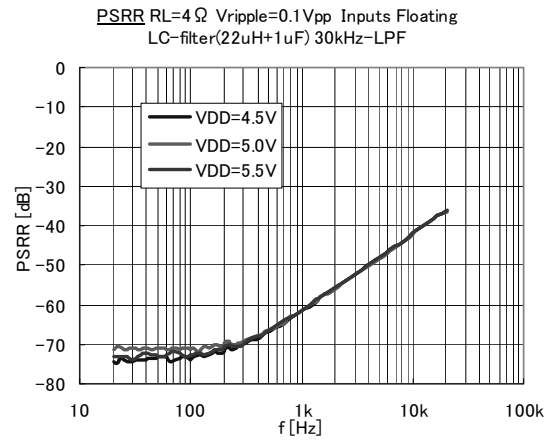

Fig.28

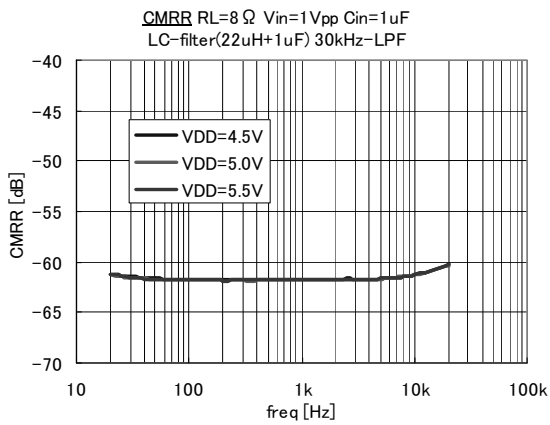

Fig.29

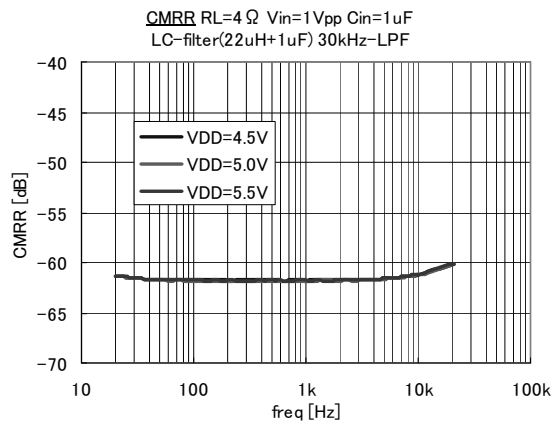

Fig.30

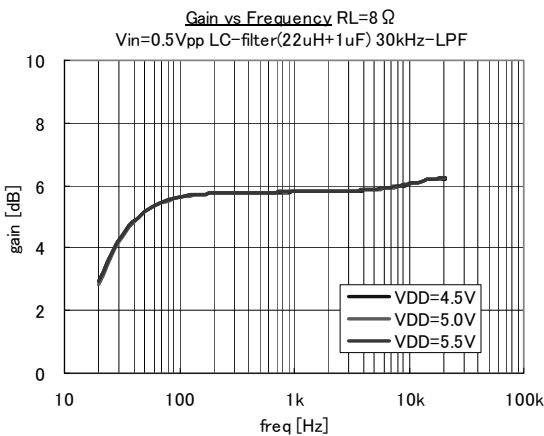

Fig.31

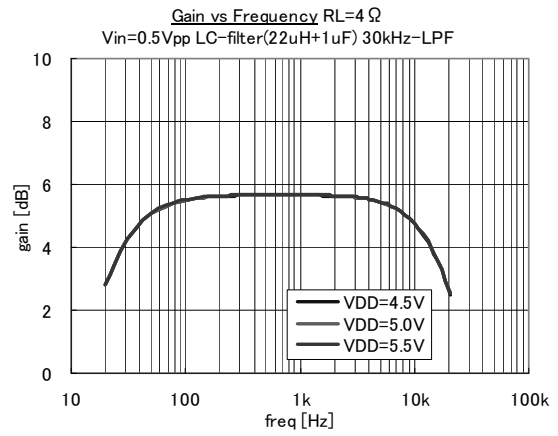

Fig.32

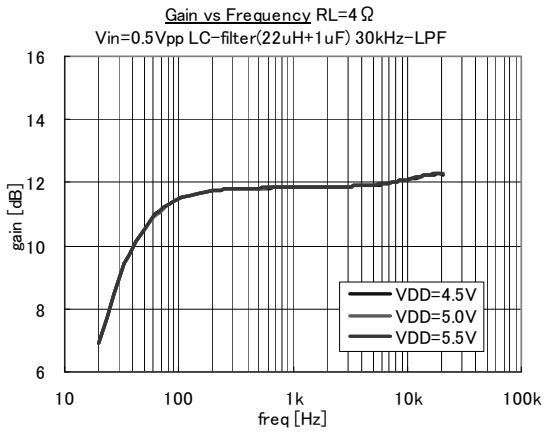

Fig.33

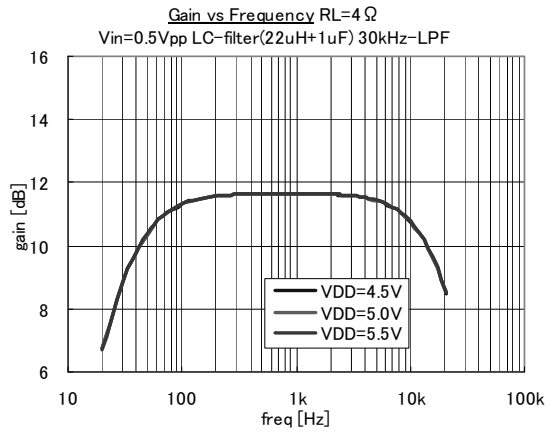

Fig.34

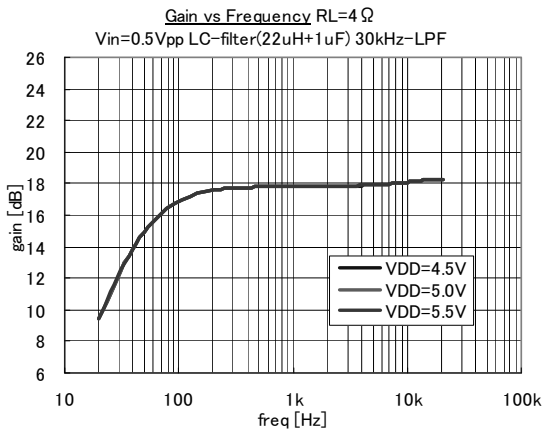

Fig.35

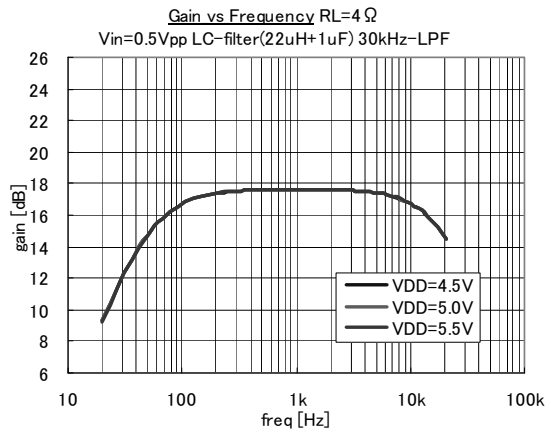

Fig.36

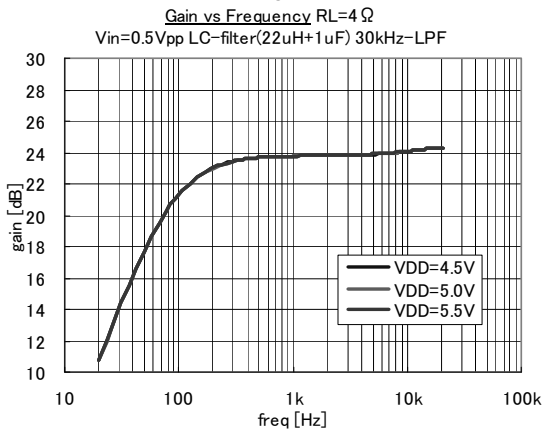

Fig.37

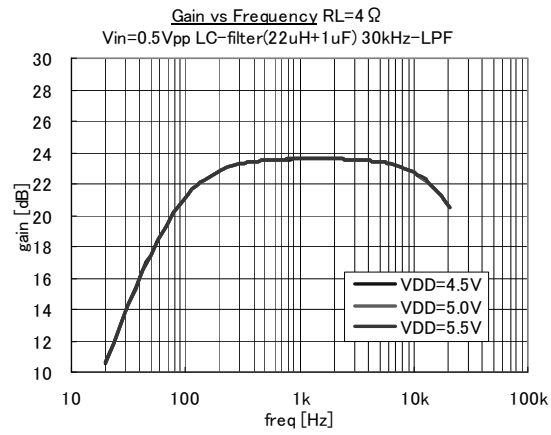
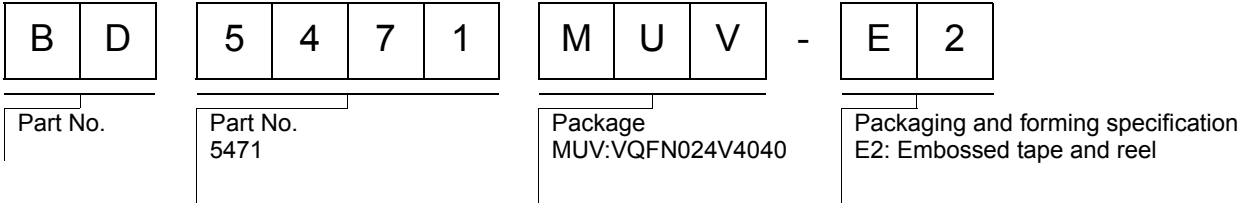

Fig.38

**●Notes for use**

- (1) Absolute maximum ratings  
This IC may be damaged if the absolute maximum ratings for the applied voltage, temperature range, or other parameters are exceeded. Therefore, avoid using a voltage or temperature that exceeds the absolute maximum ratings. If it is possible that absolute maximum ratings will be exceeded, use fuses or other physical safety measures and determine ways to avoid exceeding the IC's absolute maximum ratings.
- (2) GND terminal's potential  
Try to set the minimum voltage for GND terminal's potential, regardless of the operation mode.
- (3) Shorting between pins and mounting errors  
When mounting the IC chip on a board, be very careful to set the chip's orientation and position precisely. When the power is turned on, the IC may be damaged if it is not mounted correctly. The IC may also be damaged if a short occurs (due to a foreign object, etc.) between two pins, between a pin and the power supply, or between a pin and the GND.
- (4) Operation in strong magnetic fields  
Note with caution that operation faults may occur when this IC operates in a strong magnetic field.
- (5) Thermal design  
Ensure sufficient margins to the thermal design by taking in to account the allowable power dissipation during actual use modes, because this IC is power amp. When excessive signal inputs which the heat dissipation is insufficient condition, it is possible that thermal shutdown circuit is active.
- (6) Thermal shutdown circuit  
This product is provided with a built-in thermal shutdown circuit. When the thermal shutdown circuit operates, the output transistors are placed under open status. The thermal shutdown circuit is primarily intended to shut down the IC avoiding thermal runaway under abnormal conditions with a chip temperature exceeding  $T_{jmax} = +150^{\circ}\text{C}$ , and is not intended to protect and secure an electrical appliance.
- (7) Load of the output terminal  
This IC corresponds to dynamic speaker load, and doesn't correspond to the load except for dynamic speakers.
- (8) The short protection of the output terminal  
This IC is built in the short protection for a protection of output transistors. When the short protection is operated, output terminal become Hi-Z condition and is stopped with latch. Once output is stopped with latch, output does not recover automatically by canceling the short-circuiting condition. The condition of stopping with latch is cancelled, when power supply or mute signal is turned off and turned on again.
- (9) Operating ranges  
The rated operating power supply voltage range ( $V_{DD}=+4.5\text{V} \sim +5.5\text{V}$ ) and the rated operating temperature range ( $T_a=-40^{\circ}\text{C} \sim +85^{\circ}\text{C}$ ) are the range by which basic circuit functions is operated. Characteristics and rated output power are not guaranteed in all power supply voltage ranges or temperature ranges.
- (10) Electrical characteristics  
Electrical characteristics show the typical performance of device and depend on board layout, parts, power supply. The standard value is in mounting device and parts on surface of ROHM's board directly.
- (11) Maximum output power  
When stereo inputs at  $R_L=4\ \Omega$ , maximum output power may not achieve up to typical value because the device heats. Ensure sufficient margins to the thermal design to get larger output power.
- (12) Power decoupling capacitor  
Because the big peak current flows through the power line, the class-D amplifier has an influence on the Audio characteristic by the capacitance value or the arrangement part of the power decoupling capacitor.
- (13) Power supply  
Use single power supply, because power supplies (4,10,15,21pin) of audio amplifier and regulator are shorted inside. Audio

●Ordering part number



VQFN024V4040

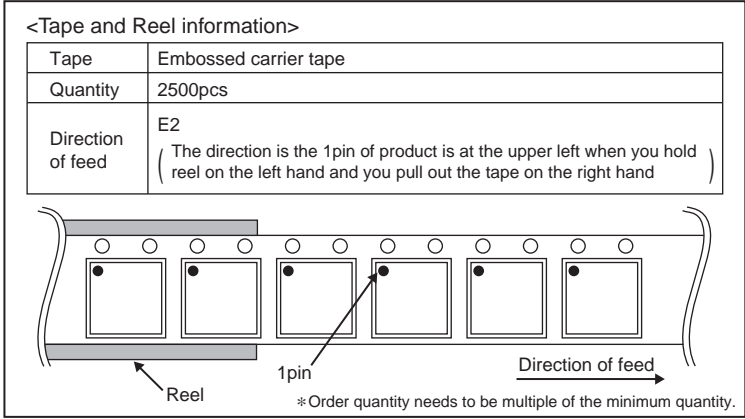
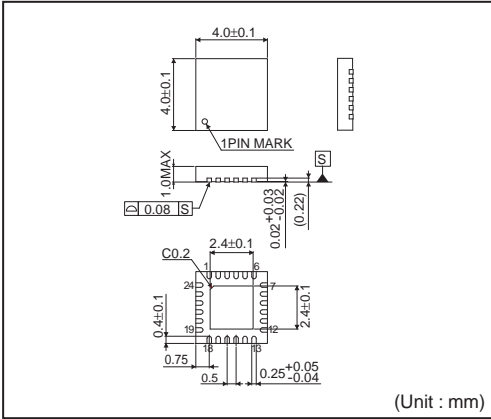

## Notes

No copying or reproduction of this document, in part or in whole, is permitted without the consent of ROHM Co.,Ltd.

The content specified herein is subject to change for improvement without notice.

The content specified herein is for the purpose of introducing ROHM's products (hereinafter "Products"). If you wish to use any such Product, please be sure to refer to the specifications, which can be obtained from ROHM upon request.

Examples of application circuits, circuit constants and any other information contained herein illustrate the standard usage and operations of the Products. The peripheral conditions must be taken into account when designing circuits for mass production.

Great care was taken in ensuring the accuracy of the information specified in this document. However, should you incur any damage arising from any inaccuracy or misprint of such information, ROHM shall bear no responsibility for such damage.

The technical information specified herein is intended only to show the typical functions of and examples of application circuits for the Products. ROHM does not grant you, explicitly or implicitly, any license to use or exercise intellectual property or other rights held by ROHM and other parties. ROHM shall bear no responsibility whatsoever for any dispute arising from the use of such technical information.

The Products specified in this document are intended to be used with general-use electronic equipment or devices (such as audio visual equipment, office-automation equipment, communication devices, electronic appliances and amusement devices).

The Products specified in this document are not designed to be radiation tolerant.

While ROHM always makes efforts to enhance the quality and reliability of its Products, a Product may fail or malfunction for a variety of reasons.

Please be sure to implement in your equipment using the Products safety measures to guard against the possibility of physical injury, fire or any other damage caused in the event of the failure of any Product, such as derating, redundancy, fire control and fail-safe designs. ROHM shall bear no responsibility whatsoever for your use of any Product outside of the prescribed scope or not in accordance with the instruction manual.

The Products are not designed or manufactured to be used with any equipment, device or system which requires an extremely high level of reliability the failure or malfunction of which may result in a direct threat to human life or create a risk of human injury (such as a medical instrument, transportation equipment, aerospace machinery, nuclear-reactor controller, fuel-controller or other safety device). ROHM shall bear no responsibility in any way for use of any of the Products for the above special purposes. If a Product is intended to be used for any such special purpose, please contact a ROHM sales representative before purchasing.

If you intend to export or ship overseas any Product or technology specified herein that may be controlled under the Foreign Exchange and the Foreign Trade Law, you will be required to obtain a license or permit under the Law.



Thank you for your accessing to ROHM product informations.  
More detail product informations and catalogs are available, please contact us.

## ROHM Customer Support System

<http://www.rohm.com/contact/>