

Crystal to LVPECL Clock Generator

Features

- One LVPECL output pair
- External crystal frequency: 25.0 MHz
- Selectable Output Frequency: 62.5 MHz or 75 MHz
- Low RMS phase jitter at 75 MHz, using 25 MHz crystal (1.5 MHz–10 MHz): 0.27 ps (typical)
- Low RMS phase jitter at 62.5 MHz, using 25 MHz crystal (1.5 MHz–10 MHz): 0.38 ps (typical)
- Pb-free 8-Pin TSSOP package
- Supply voltage: 3.3V
- Commercial Temperature Range

Functional Description

The CY2XP41 is a PLL (Phase Locked Loop) based high performance clock generator. It is optimized to generate high performance clock frequencies for DVD-R applications. It uses Cypress's low noise VCO technology to achieve less than 1 ps typical RMS phase jitter, that meets application jitter requirements. The CY2XP41 has a crystal oscillator interface input and one LVPECL output pair.

Logic Block Diagram

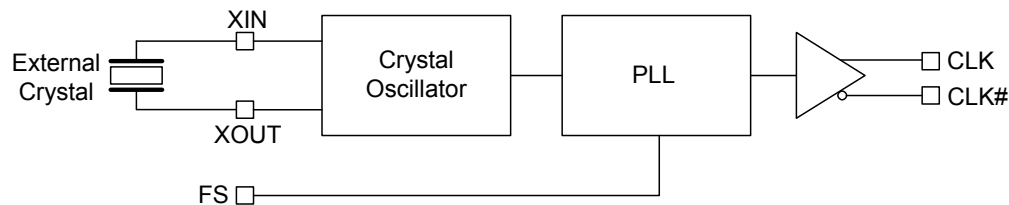

Pinouts

Figure 1. Pin Diagram - 8 Pin TSSOP

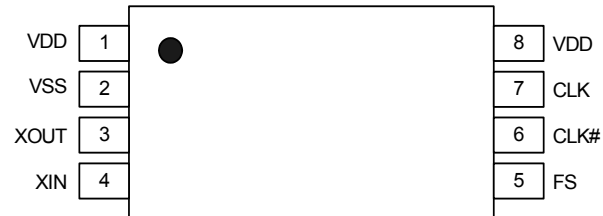

Table 1. Pin Definitions - 8 Pin TSSOP

Pin	Name	Type	Description
1, 8	VDD	Power	3.3V power supply. All supply current flows through pin 1
2	VSS	Power	Ground
3, 4	XOUT, XIN	XTAL output and input	Parallel resonant crystal interface
5	FS	LVC MOS/LVTTL input	Frequency Select Input, See “Frequency Table” on page 3
6,7	CLK#, CLK	LVPECL output	Differential Clock Output

Frequency Table

Input		Output Frequency (MHz)
Input Xtal Frequency (MHz)	FS	
25	0	62.5
25	1	75.0

Absolute Maximum Conditions

Parameter	Description	Condition	Min	Max	Unit
V _{DD}	Supply Voltage		-0.5	4.4	V
V _{IN} ^[1.]	Input Voltage, DC	Relative to VSS	-0.5	V _{DD} + 0.5	V
T _S	Temperature, Storage	Non Functional	-65	150	°C
T _J	Temperature, Junction			135	°C
ESD _{HBM}	ESD Protection (Human Body Model)	JEDEC STD 22-A114-B	2000		V
UL-94	Flammability Rating	At 1/8 in.	V-0		
Θ _{JA} ^[2]	Thermal Resistance, Junction to Ambient	0 m/s airflow	100		°C/W
		1 m/s airflow	91		
		2.5 m/s airflow	87		

Operating Conditions

Parameter	Description	Min	Max	Unit
V _{DD}	3.3V Supply Voltage	3.135	3.465	V
T _A	Ambient Temperature, Commercial	0	70	°C
T _{PU}	Power up time for all V _{DD} to reach minimum specified voltage (ensure power ramps are monotonic)	0.05	500	ms

Electrical Characteristics for Input

Parameter	Description	Test Conditions	Min	Typ	Max	Unit
V _{IL}	Input Low Voltage		-	-	0.3*V _{DD}	V
V _{IH}	Input High Voltage		0.7*V _{DD}	-	-	V
I _{IL}	Input Low Current	FS = V _{SS}	-50	-	-	μA
I _{IH}	Input High Current	FS = V _{DD}	-	-	115	μA
C _{IN}	Input Capacitance			15		pF

DC Electrical Characteristics for Power Supplies

Parameter	Description	Min	Typ	Max	Unit
I _{DD} ^[3]	Power Supply Current with output terminated	-	-	180	mA

Note

1. The voltage on any input or IO pin cannot exceed the power pin during power up. Power supply sequencing is NOT required.
2. Simulated using Apache Sentinel TI software. The board is derived from the JEDEC multilayer standard. It measures 76 x 114 x 1.6 mm and has 4-layers of copper (2/11/2 oz.). The internal layers are 100% copper planes, while the top and bottom layers have 50% metallization. No vias are included in the model.
3. I_{DD} includes ~16 mA of current that is dissipated externally in the output termination resistors.

DC Electrical Characteristics for LVPECL Output

Parameter	Description	Min	Typ	Max	Unit
V _{CM}	Common-Mode Voltage (CLK + CLK#) / 2, defined in Figure 5 on page 5, using Figure 2 on page 5 circuit.	175	–	2000	mV
V _{PP}	Differential Peak Output Voltage, defined in Figure 5 on page 5, using Figure 2 on page 5 circuit.	350	780	850	mV

Crystal Characteristics

Parameter	Description	Min	Typ	Max	Unit
	Mode of Oscillation	Fundamental			
F	Frequency	–	25	–	MHz
ESR	Equivalent Series Resistance	–	–	50	Ω
C _L	Crystal Load Capacitance	–	10	–	pF
C _S	Shunt Capacitance	–	–	7	pF
DL	Crystal Drive Level	–	–	300	μW

AC Characteristics

Parameter	Description	Test Conditions	Min	Typ	Max	Unit
F _{OUT}	Output Frequency		62.5	–	75.0	MHz
T _R /T _F	Output Rise/Fall time	Defined in Figure 5 on page 5	–	350	–	ps
T _{Jitter(φ)}	RMS Phase Jitter (Random)	75 MHz, (1.5 MHz - 10 MHz filter), 3.3V	–	0.27	–	ps
		62.5 MHz, (1.5 MHz - 10 MHz filter), 3.3V	–	0.38	–	ps
T _{DC}	Duty Cycle	Defined in Figure 4 on page 5	45	–	55	%

Measurement Definitions

Figure 2. Output Load AC Test Circuit

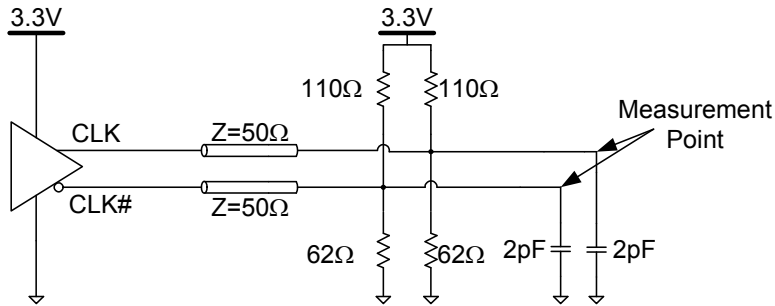

Figure 3. RMS Phase Jitter

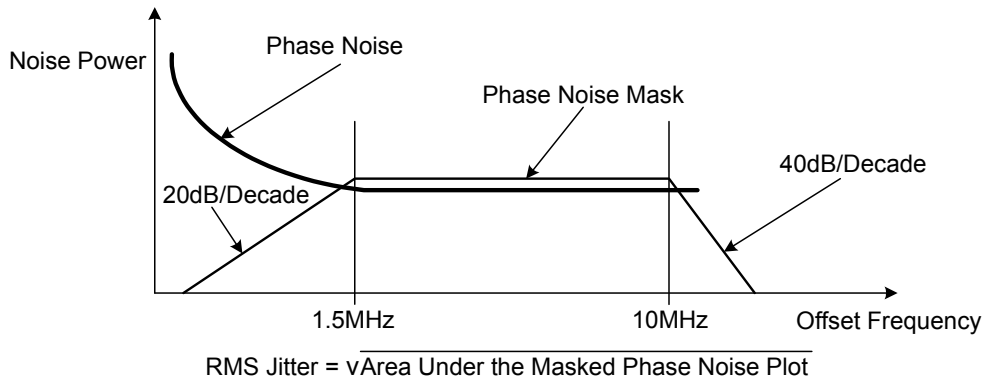

Figure 4. Output Duty Cycle

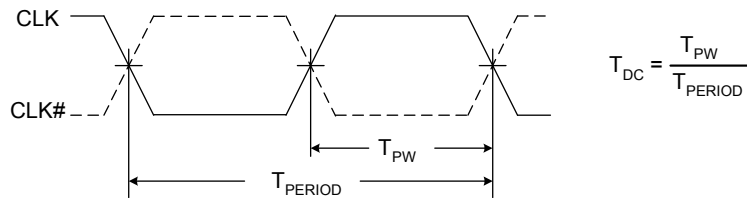
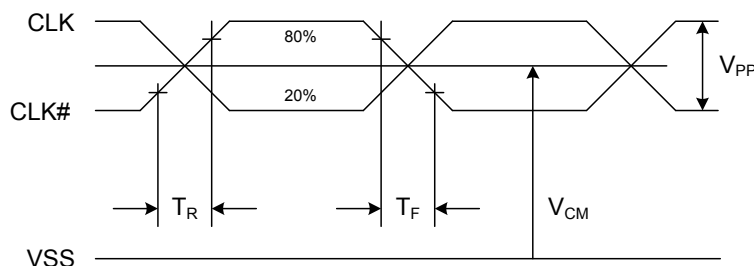

Figure 5. Output Rise and Fall Time and Peak-Peak Voltage Swing



Application Information

Power Supply Filtering Techniques

As in any high speed analog circuitry, noise at the power supply pins degrades performance. To achieve optimum jitter performance, good power supply isolation practices are advised. Figure 6. shows a typical filtering scheme. Since all of the current flows through pin 1, the resistance and inductance between this pin and the supply is minimized. A 0.01 or 0.1 μF ceramic chip capacitor is also located close to this pin to provide a short and low impedance AC path to ground. A ~ 5 to 10 μF tantalum capacitor is also located in the vicinity of this device.

Figure 6. Power Supply Filtering

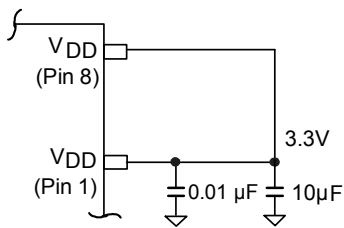

Termination for 3.3V LVPECL Output

CLK and CLK# are pull up drivers that generate ECL/LVPECL compatible outputs. Therefore, terminating resistors (DC current path to ground) or current sources are used for functionality. Matched impedance techniques are used to maximize operating frequency and minimize signal distortion. Figure 2 on page 5 shows a termination scheme that is recommended as a guideline. Other suitable clock layouts exist and it is recommended that the board designers simulate to guarantee compatibility across all printed circuit and process variations. **Cypress recommends the following RU and RD values: RU=110 Ω and RD=62 Ω .** This is a 40 Ω load, which is used to achieve the specified common mode and peak-to-peak voltage swing. For optimal signal integrity, 40 Ω traces are recommended.

Crystal Input Interface

The CY2XP41 is characterized with 10 pF parallel resonant crystals. The capacitor values shown in Figure 7. are determined using a 25 MHz 10 pF parallel resonant crystal and are chosen to minimize the ppm error. **Cypress recommends the following C1 and C2 values: C1 = C2 = 6.8pF.**

Figure 7. Crystal Input Interface

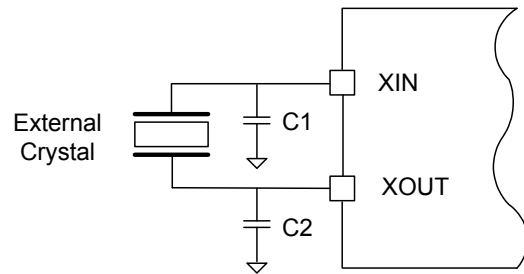

Ordering Information

Part Number	Package Type	Product Flow
CY2XP41ZXC	8-Pin TSSOP	Commercial, 0°C to 70°C
CY2XP41ZXCT	8-Pin TSSOP–Tape and Reel	Commercial, 0°C to 70°C

Package Drawing and Dimensions

Figure 8. 8-Pin Thin Shrunk Small Outline Package (4.40mm Body) Z8

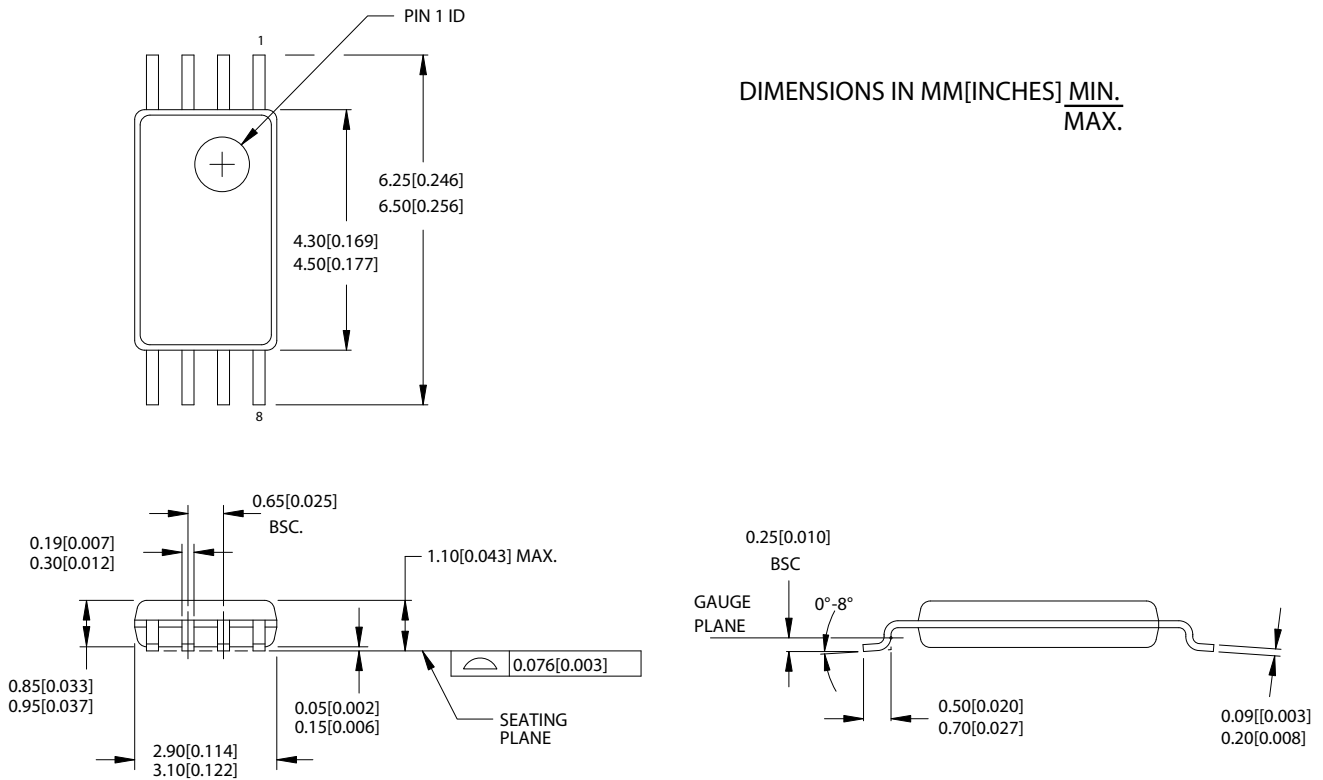

51-85093-*A

Document History Page

Document Title: CY2XP41 Crystal to LVPECL Clock Generator Document Number: 001-48923				
REV.	ECN NO.	Submission Date	Orig. of Change	Description of Change
**	2669117	03/05/09	XHT/CXQ/ KVM	New data sheet
*A	2718433	06/12/09	WWZ/HMT	No change. Submit to ECN for product launch.

Sales, Solutions, and Legal Information

Worldwide Sales and Design Support

Cypress maintains a worldwide network of offices, solution centers, manufacturer’s representatives, and distributors. To find the office closest to you, visit us at cypress.com/sales.

Products

PSoC	psoc.cypress.com
Clocks & Buffers	clocks.cypress.com
Wireless	wireless.cypress.com
Memories	memory.cypress.com
Image Sensors	image.cypress.com

PSoC Solutions

General	psoc.cypress.com/solutions
Low Power/Low Voltage	psoc.cypress.com/low-power
Precision Analog	psoc.cypress.com/precision-analog
LCD Drive	psoc.cypress.com/lcd-drive
CAN 2.0b	psoc.cypress.com/can
USB	psoc.cypress.com/usb

© Cypress Semiconductor Corporation, 2009. The information contained herein is subject to change without notice. Cypress Semiconductor Corporation assumes no responsibility for the use of any circuitry other than circuitry embodied in a Cypress product. Nor does it convey or imply any license under patent or other rights. Cypress products are not warranted nor intended to be used for medical, life support, life saving, critical control or safety applications, unless pursuant to an express written agreement with Cypress. Furthermore, Cypress does not authorize its products for use as critical components in life-support systems where a malfunction or failure may reasonably be expected to result in significant injury to the user. The inclusion of Cypress products in life-support systems application implies that the manufacturer assumes all risk of such use and in doing so indemnifies Cypress against all charges.

Any Source Code (software and/or firmware) is owned by Cypress Semiconductor Corporation (Cypress) and is protected by and subject to worldwide patent protection (United States and foreign), United States copyright laws and international treaty provisions. Cypress hereby grants to licensee a personal, non-exclusive, non-transferable license to copy, use, modify, create derivative works of, and compile the Cypress Source Code and derivative works for the sole purpose of creating custom software and or firmware in support of licensee product to be used only in conjunction with a Cypress integrated circuit as specified in the applicable agreement. Any reproduction, modification, translation, compilation, or representation of this Source Code except as specified above is prohibited without the express written permission of Cypress.

Disclaimer: CYPRESS MAKES NO WARRANTY OF ANY KIND, EXPRESS OR IMPLIED, WITH REGARD TO THIS MATERIAL, INCLUDING, BUT NOT LIMITED TO, THE IMPLIED WARRANTIES OF MERCHANTABILITY AND FITNESS FOR A PARTICULAR PURPOSE. Cypress reserves the right to make changes without further notice to the materials described herein. Cypress does not assume any liability arising out of the application or use of any product or circuit described herein. Cypress does not authorize its products for use as critical components in life-support systems where a malfunction or failure may reasonably be expected to result in significant injury to the user. The inclusion of Cypress’ product in a life-support systems application implies that the manufacturer assumes all risk of such use and in doing so indemnifies Cypress against all charges.

Use may be limited by and subject to the applicable Cypress software license agreement.