



Size:  
1.91 x 1.09 x 0.37 in  
48,6 x 27,7 x 9,5 mm

### Applications

- Solid state lighting
- Stadium displays
- Industrial controls
- Avionics
- Underseas
- RF Amplifiers
- Microprocessor and DSP requiring fast response

### Features

- 100°C baseplate operation
- Vin range: 38 – 55 Vdc
- Factorized Power
- High density: up to 416 W/in<sup>3</sup>
- Small footprint: 1.64 and 2.08 in<sup>2</sup>
- Height above board: 0.37 in (9.5 mm)
- Low weight: 1.07 oz (30.4 g)
- ZVS buck-boost regulator
- Typical efficiency: 97%
- 1.0 MHz switching frequency
- Low noise operation
- Architectural flexibility
- Lead free wave solder compatible
- Agency approvals

### Product Overview

The VI BRICK Pre-Regulator Module is a very efficient non-isolated regulator specifically designed to provide a controlled Factorized Bus distribution voltage for powering downstream VI BRICK Voltage Transformation Modules. In combination, VI BRICK PRMs and VTMs™ form a complete DC-DC converter subsystem offering all of the unique benefits of Vicor's Factorized Power Architecture (FPA): high density and efficiency; low noise operation; architectural flexibility; extremely fast transient response; elimination of bulk capacitance at the Point-of-Load (POL); in a thermally enhanced package.

### Part Numbering

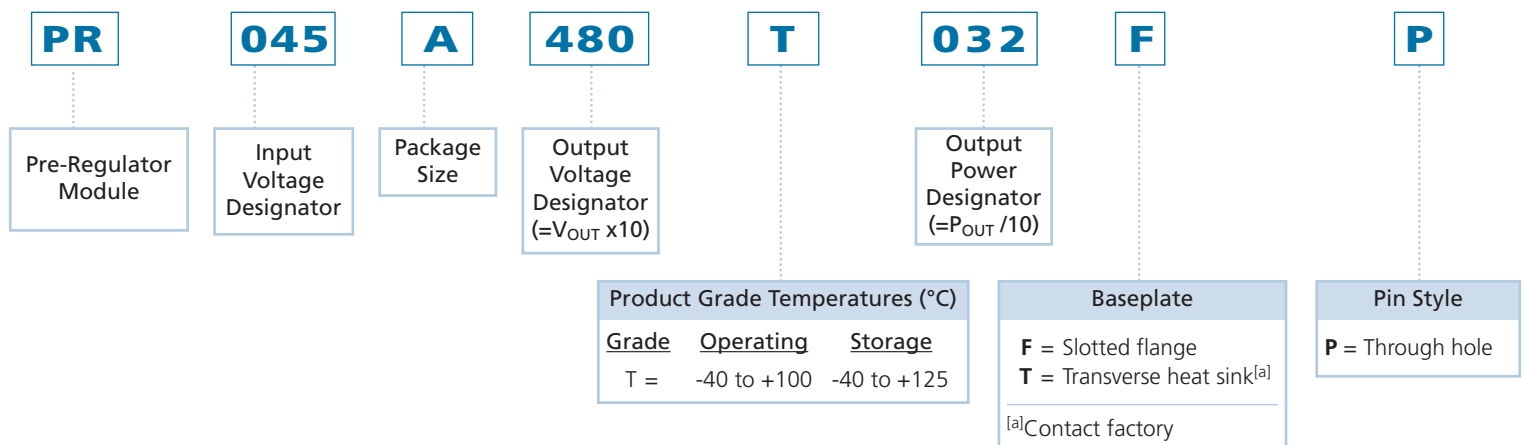

## SPECIFICATIONS

Electrical characteristics apply over the full operating range of input voltage, output load (resistive) and baseplate temperature, unless otherwise specified. All temperatures refer to the operating temperature at the center of the baseplate.

Absolute Maximum Ratings			
Parameter	Values	Unit	Notes
+In to -In	-1.0 to 59.0	Vdc	
PC to -In	-0.3 to 6.0	Vdc	
PR to -In	-0.3 to 9.0	Vdc	
IL to -In	-0.3 to 6.0	Vdc	
VC to -In	-0.3 to 18.0	Vdc	
+Out to -Out	-0.3 to 59	Vdc	
SC to -Out	-0.3 to 3.0	Vdc	
VH to -Out	-0.3 to 9.5	Vdc	
OS to -Out	-0.3 to 9.0	Vdc	
CD to -Out	-0.3 to 9.0	Vdc	
SG to -Out	100	mA	
Continuous output current	6.67	Adc	
Continuous output power	320	W	
Operating temperature	-40 to +100	°C	T-Grade; baseplate
Storage temperature	-40 to +125	°C	T-Grade

**Note:** Stresses in excess of the maximum ratings can cause permanent damage to the device. Operation of the device is not implied at these or any other conditions in excess of those given in the specification. Exposure to absolute maximum ratings can adversely affect device reliability.

Input Specifications <i>(Conditions are at 45 Vin, 48 Vf<sup>[a]</sup>, full load, and 25°C ambient unless otherwise specified)</i>					
Parameter	Min	Typ	Max	Unit	Notes
Input voltage range	38	45	55	Vdc	
Input dV/dt			1	V/μs	
Input undervoltage turn-on		35.7	37.3	Vdc	
Input undervoltage turn-off	32.1	33.6		Vdc	
Input overvoltage turn-on	55.5	56.6		Vdc	
Input overvoltage turn-off		57.7	59.4	Vdc	
Input quiescent current		0.5	1	mA	PC low
Input current		7.3		Adc	
Input reflected ripple current		760		mA p-p	See Figures 3 & 4
No load power dissipation		3.0	6.0	W	
Internal input capacitance		5		μF	Ceramic
Recommended external input capacitance		100		μF	See Figure 4 for input filter circuit. Source impedance dependent

<sup>[a]</sup> Vf is factorized bus voltage (see Figure 15).

# SPECIFICATIONS (CONT.)

## INPUT WAVEFORMS

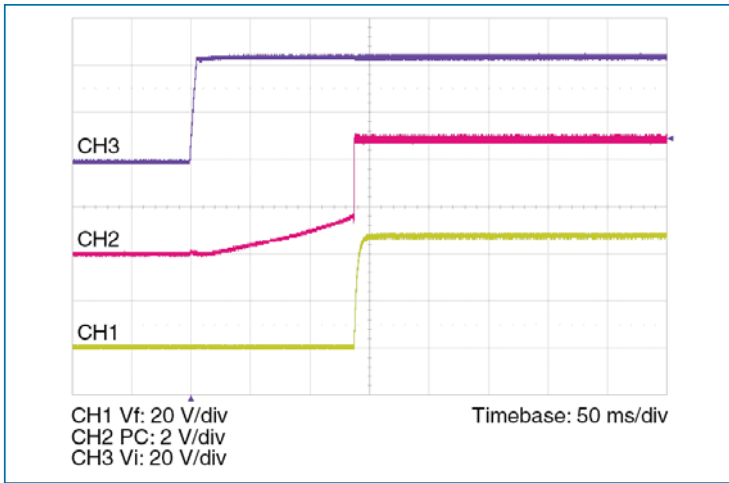

Figure 1 — Vf and PC response from power up

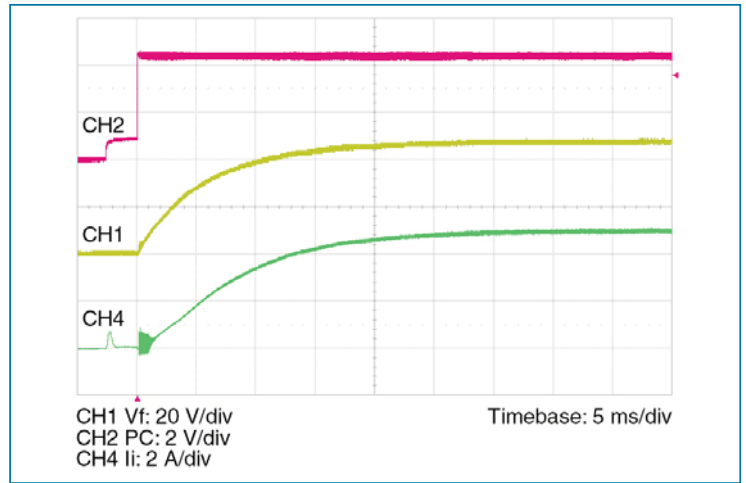

Figure 2 — Vf turn-on waveform with inrush current – PC enabled

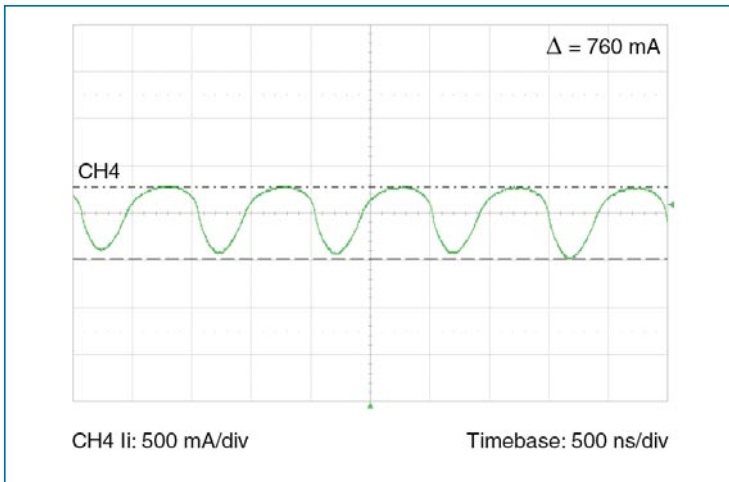

Figure 3 — Input reflected ripple current

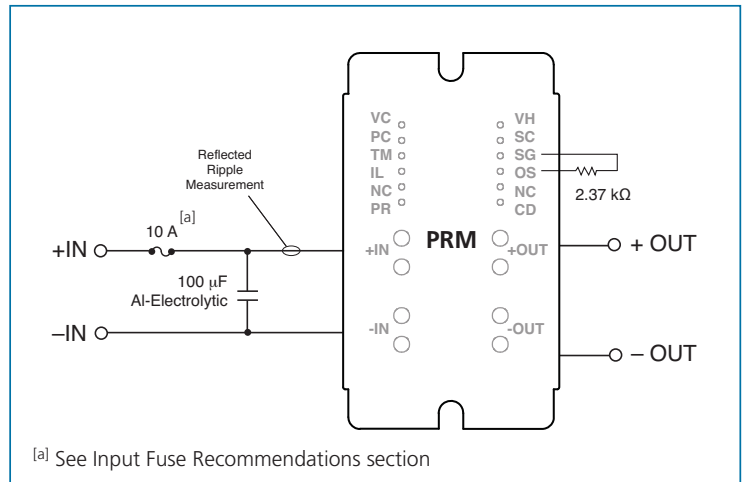

Figure 4 — Input filter capacitor recommendation

**Output Specifications** (Conditions are at 45 Vin, 48 Vf<sup>[a]</sup>, full load, and 25°C ambient unless otherwise specified)

Parameter	Min	Typ	Max	Unit	Note
Output voltage range	26	48	55	Vdc	Factorized Bus voltage (Vf) set by R <sub>OS</sub>
Output power	0		320	W	
Output current	0		6.67	Adc	
DC current limit	7.0	8.0	8.8	Adc	I <sub>L</sub> pin floating
Average short circuit current			0.5	A	Auto recovery
Set point accuracy		1.5		%	
Line regulation		0.3	0.5	%	Low line to high line
Load regulation		0.5	0.7	%	No CD resistor
Load regulation (at VTM output)		1.0	2.0	%	Adaptive Loop
Current share accuracy		5	10	%	
Efficiency					
Full load		97.4		%	See Figure 5,6 & 7
Output overvoltage set point	56		59.4	Vdc	
Output ripple voltage					
No external bypass		2.6	4.0	%	Factorized Bus, see Figure 12
With 10 µF capacitor		1.4	2.2	%	Factorized Bus, See Figure 13
Switching frequency	.93	1.00	1.08	MHz	Fixed frequency - across entire operating range
Output turn-on delay					
From application of power		135	230	ms	See Figure 1
From PC pin high		100		µs	See Figure 2
Internal output capacitance		5		µF	Ceramic
Factorized Bus capacitance			47	µF	

OUTPUT WAVEFORMS

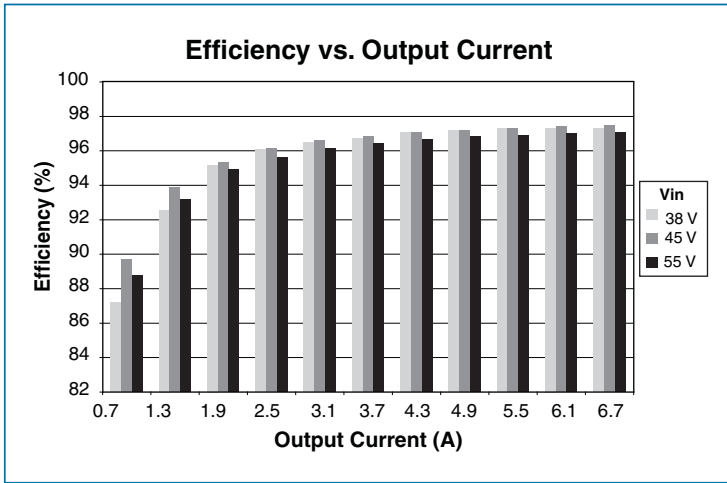

Figure 5 — Efficiency vs. output current at 48 Vf

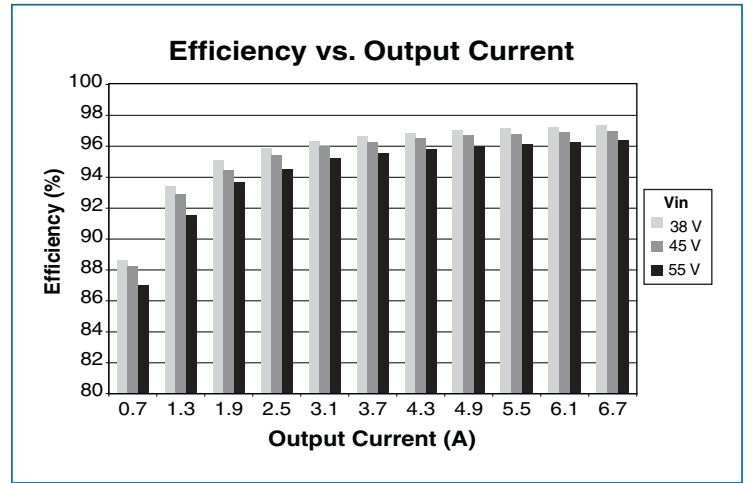

Figure 6 — Efficiency vs. output current at 36 Vf

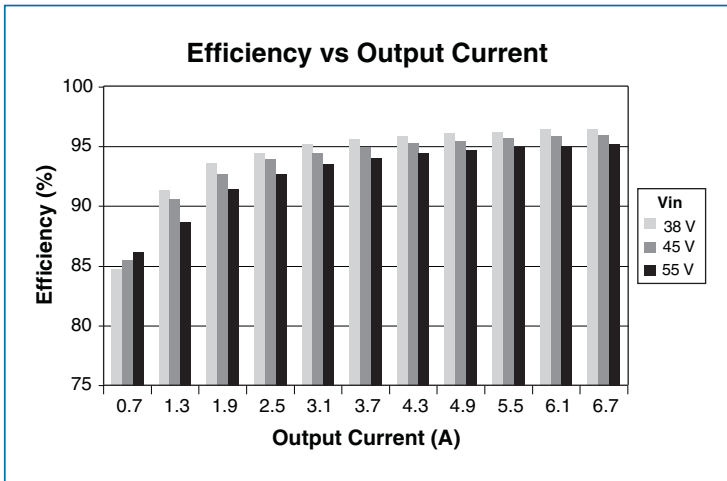
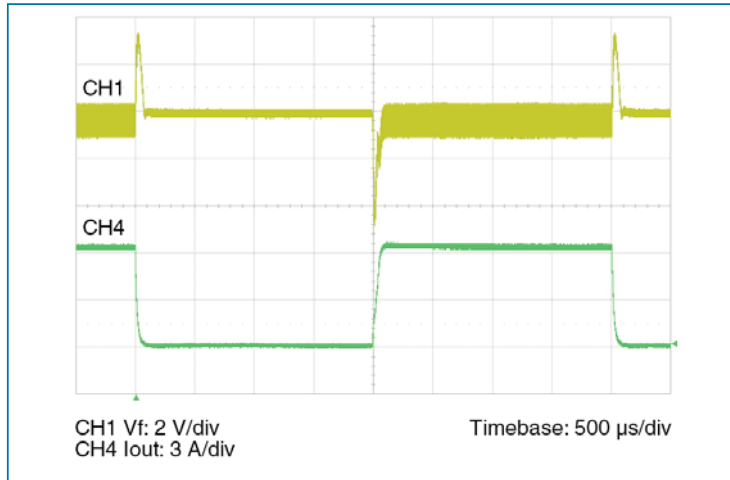

Figure 7 — Efficiency vs. output current at 26 Vf

# SPECIFICATIONS (CONT.)

## OUTPUT WAVEFORMS



**Figure 8** — Transient response; PRM alone 45 Vin, 0-6.7-0 A, no load capacitance, local loop

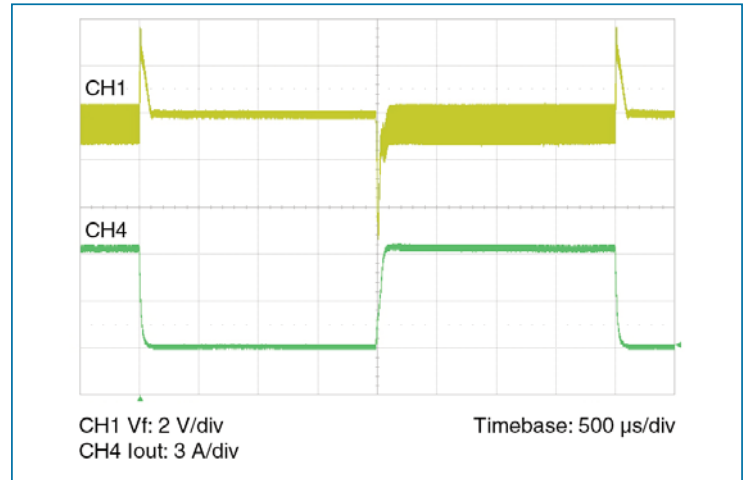

**Figure 9** — Transient response; PRM alone 38 Vin, 0-6.7-0 A no load capacitance, local loop

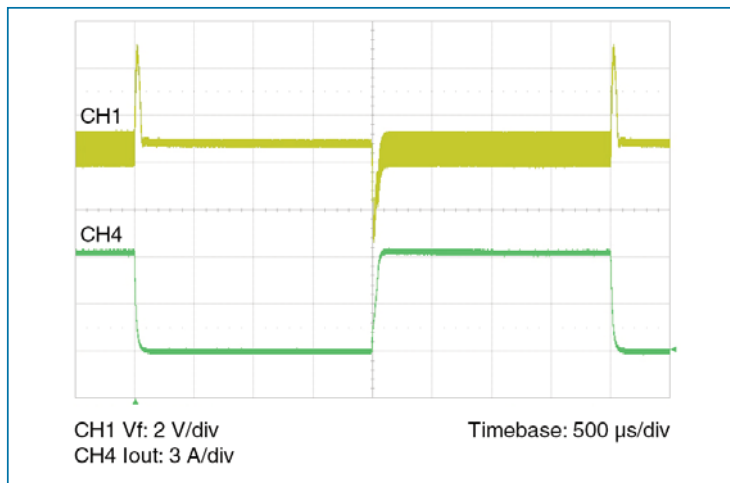

**Figure 10** — Transient response; PRM alone 55 Vin, 0-6.7-0 A no load capacitance, local loop.

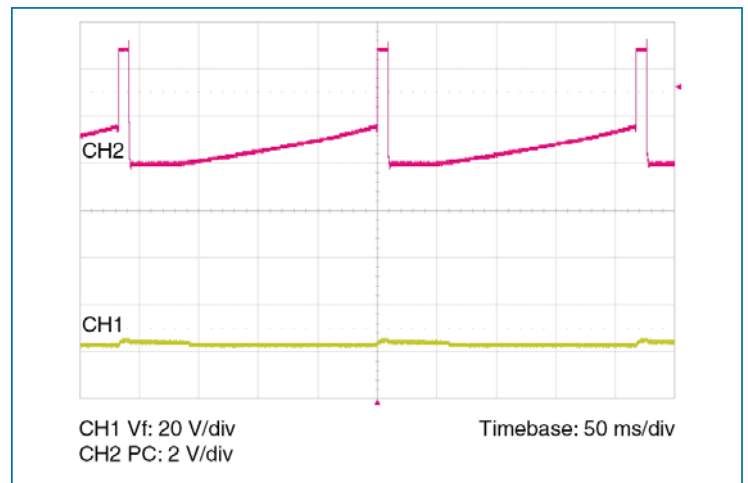

**Figure 11** — PC during fault – frequency will vary as a function of line voltage

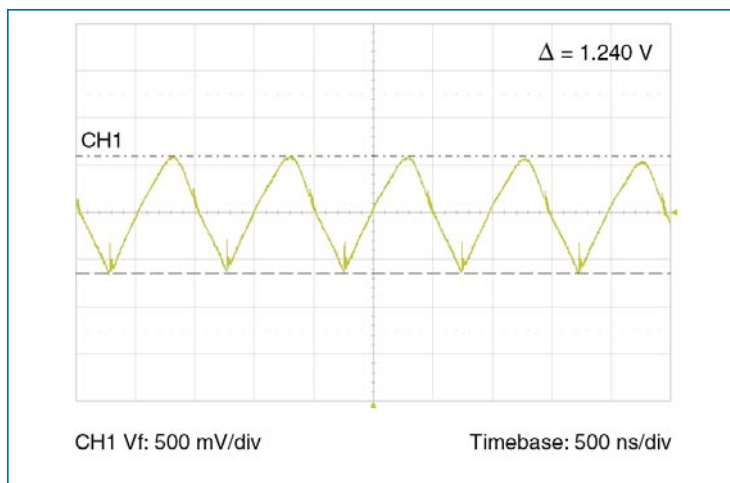

**Figure 12** — Output ripple full load no bypass capacitance

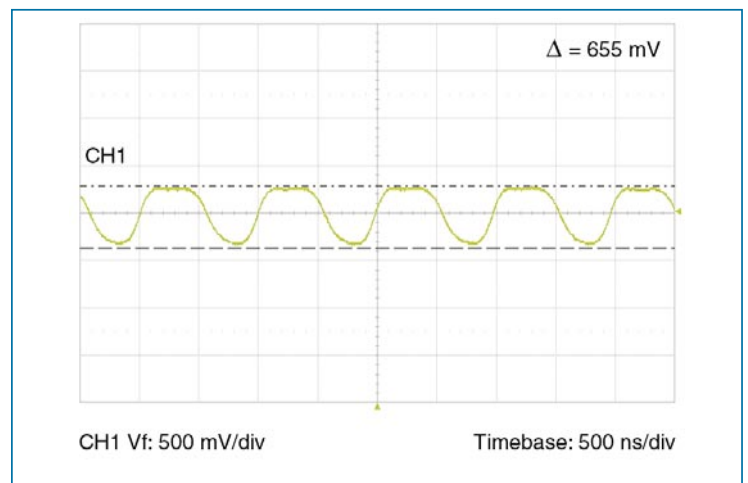

**Figure 13** — Output ripple full load 10  $\mu$ F bypass capacitance

## General Specifications

Parameter	Min	Typ	Max	Unit	Notes
MTBF					
MIL-HDBK-217F		2.2		Mhrs	25°C, GB
<a href="#">Agency approvals</a>		CTÜVus			UL/CSA 60950-1, EN60950-1
		CE Mark			Low voltage directive
		RoHS			Complies with RoHS
Mechanical parameters					See Mechanical Drawings, Figures 19 & 20
Weight		1.07/30,4		oz/g	
Dimensions					
Length		1.91/48,6		in/mm	
Width		1.09/27,7		in/mm	
Height		0.37/9,5		in/mm	
Thermal					
Over temperature shutdown	130	135	140	°C	junction temperature
Thermal capacity		23.8		Ws/°C	
Baseplate to ambient		8.8		°C/W	
Baseplate to ambient; 1000 LFM		3.0		°C/W	
Baseplate to sink; flat, greased surface		0.40		°C/W	
Baseplate to sink; thermal pad		0.36		°C/W	

## Auxiliary Pins

Parameter	Min	Typ	Max	Unit	Notes
VC (VTM Control)					
Pulse width	8	12	18	ms	
Peak voltage	12	14	18	V	Referenced to –Out
PC (Primary Control)					
DC voltage	4.8	5.0	5.2	Vdc	Referenced to –In
Module disable voltage	2.3	2.4		Vdc	Referenced to –In
Module enable voltage		2.5	2.6	Vdc	
Disable hysteresis		100		mV	
Current limit		1.75	1.90	mA	Source only after start up; not to be used for aux. supply; 100 kΩ minimum load impedance to assure start up.
Enable delay time		100		µs	
Disable delay time		1		µs	
IL (Current Limit Adjust)					
Voltage		1		V	
Accuracy		± 15		%	Based on DC current limit set point
PR (Parallel Port)					
Voltage	0.6		7.5	V	Referenced to SG; See description Page 8
Source current	1			mA	
External capacitance			100	pF	
VH (Auxiliary Voltage)					Typical internal bypass C=0.1 µF Maximum external C=0.1 µF, referenced to SG
Range	8.7	9.0	9.3	Vdc	
Regulation		0.04		%/mA	
Current			5	mA p	
SC (Secondary Control)					
Voltage	1.23	1.24	1.25	Vdc	Referenced to SG
Internal capacitance		0.22		µF	
External capacitance			0.7	µF	
OS (Output Set)					
Set point accuracy		± 1.5		%	Includes 1% external resistor
Reference offset		± 4		mV	
CD (Compensation Device)					
External resistance	20			Ω	Omit resistor for regulation at output of PRM

### +In / -In DC Voltage Ports

The VI BRICK maximum input voltage should not be exceeded. PRMs have internal over / undervoltage lockout functions that prevent operation outside of the specified input range. PRMs will turn on when the input voltage rises above its undervoltage lockout. If the input voltage exceeds the overvoltage lockout, PRMs will shut down until the overvoltage fault clears. PC will toggle indicating an out of bounds condition.

### +Out / -Out Factorized Voltage Output Ports

These ports provide the Factorized Bus voltage output. The -Out port is connected internally to the -In port through a current sense resistor. The PRM has a maximum power and a maximum current rating and is protected if either rating is exceeded. Do not short -Out to -In.

### VC – VTM Control

The VTM Control (VC) port supplies an initial  $V_{CC}$  voltage to downstream VTMs, enabling the VTMs and synchronizing the rise of the VTM output voltage to that of the PRM. The VC port also provides feedback to the PRM to compensate for voltage drop due to the VTM output resistance. The PRM's VC port should be connected to the VTM VC port. A PRM VC port can drive a maximum of two (2) VTM VC ports.

### PC – Primary Control

The PRM voltage output is enabled when the PC pin is open circuit (floating). To disable the PRM output voltage, the PC pin is pulled low. Open collector optocouplers, transistors, or relays can be used to control the PC pin. When using multiple PRMs in a high power array, the PC ports must be tied together to synchronize their turn on. During an abnormal condition the PC pin will pulse (Fig.11) as the PRM initiates a restart cycle. This will continue until the abnormal condition is rectified. The PC should not be used as an auxiliary voltage supply, nor should it be switched at a rate greater than 1 Hz.

### TM – Factory Use Only

### IL – Current Limit Adjust

The PRM has a preset, maximum, current limit set point. The IL port may be used to reduce the current limit set point to a lower value. See “adjusting current limits” on page 11.

### PR – Parallel Port

The PR port signal, which is proportional to the PRM output power, supports current sharing of two PRMs. To enable current sharing, PR ports should be interconnected. Bypass capacitance should be used when interconnecting PR ports and steps should be taken to minimize coupling noise into the interconnecting bus. Terminate this port with a 10 k equivalent resistance to SG, e.g. 10 k for a single PRM, 20 k each for 2 PRMs in parallel, 30 k each for 3 PRMs in parallel etc.. Please consult Vicor Applications Engineering regarding additional considerations when paralleling more than two PRMs.

### VH – Auxiliary Voltage

VH is a gated (e.g. mirrors PC), non-isolated, nominally 9 Volt, regulated DC voltage (see “Auxiliary Pins” specifications, on Page 7) that is referenced to SG. VH may be used to power external circuitry having a total current consumption of no more than 5 mA under either transient or steady state conditions including turn-on.

### SC – Secondary Control

The load voltage may be controlled by connecting a resistor or voltage source to the SC port referenced to SG. The slew rate of the output voltage may be controlled by controlling the rate-of-rise of the voltage at the SC port (e.g., to limit inrush current into a capacitive load).

### SG – Signal Ground

This port provides a low inductance Kelvin connection to -In and should be used as reference for the OS, CD, SC, VH and IL ports.

### OS – Output Set

The application-specific value of the Factorized Bus voltage ( $V_f$ ) is set by connecting a resistor between OS and SG. Resistor value selection is shown in Table 1 on Page 9, and described on Page 10. If no resistor is connected, the PRM output will be approximately one volt. If set resistor is not collocated with the PRM, a local bypass capacitor of ~200 pF may be required.

### CD – Compensation Device

Adaptive Loop control is configured by connecting an external resistor between the CD port and SG. Selection of an appropriate resistor value (see Equation 2 on Page 10 and Table 1 on Page 9) configures the PRM to compensate for voltage drops in the equivalent output resistance of the VTM and the PRM-VTM distribution bus. If no resistor is connected to CD, the PRM will be in Local Loop mode and will regulate the +Out / -Out voltage to a fixed value.

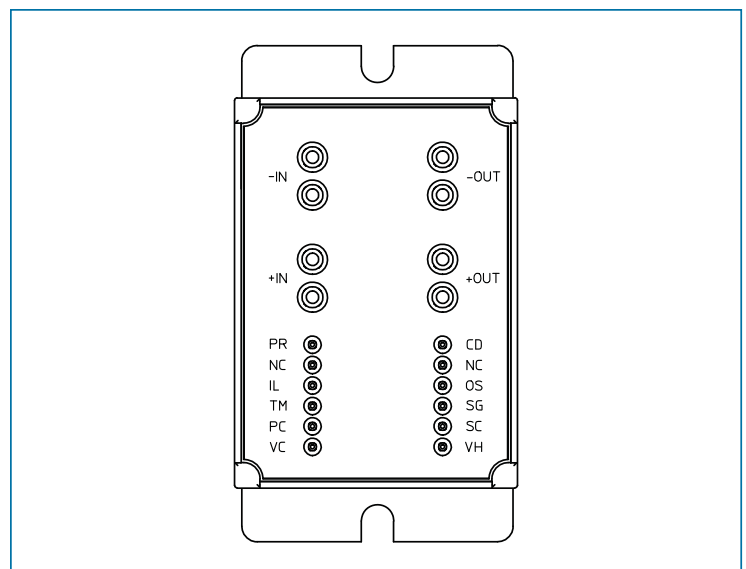

Figure 14 — VI BRICK PRM pin configuration (viewed from pin side).



## Overview of Adaptive Loop Compensation

Adaptive Loop compensation, illustrated in Figure 15, contributes to the bandwidth and speed advantage of Factorized Power. The PRM monitors its output current and automatically adjusts its output voltage to compensate for the voltage drop in the output resistance of the VTM.  $R_{OS}$  sets the desired value of the VTM output voltage,  $V_{out}$ ;  $R_{CD}$  is set to a value that compensates for the output resistance of the VTM (which, ideally, is located at the point of load). For selection of  $R_{OS}$  and  $R_{CD}$ , refer to Table 1 below or Page 10.

The VI BRICK's bi-directional VC port :

1. Provides a wake up signal from the PRM to the VTM that synchronizes the rise of the VTM output voltage to that of the PRM.
2. Provides feedback from the VTM to the PRM to enable the PRM to compensate for the voltage drop in VTM output resistance,  $R_O$ .

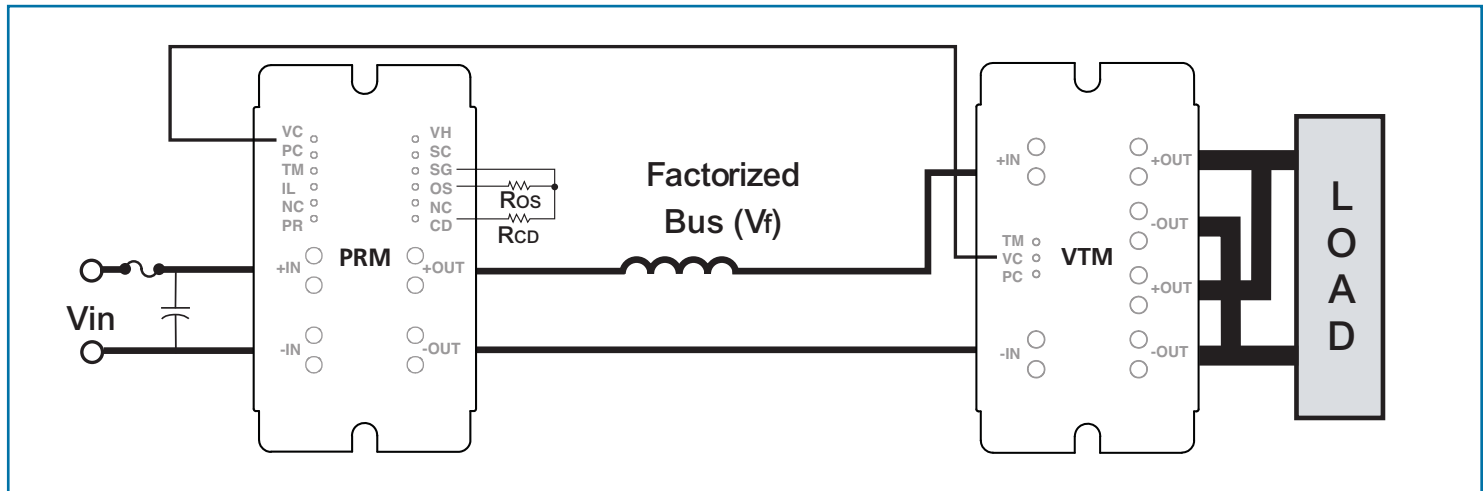

**Figure 15** — With Adaptive Loop control, the output of the VTM is regulated over the load current range with only a single interconnect between the PRM and VTM and without the need for isolation in the feedback path.

Desired Load Voltage (Vdc)	VI BRICK VTM P/N <sup>(1)</sup>	Max VTM Output Current (A) <sup>(2)</sup>	$R_{OS}$ (k $\Omega$ ) <sup>(3)</sup>	$R_{CD}$ ( $\Omega$ ) <sup>(3)</sup>
1.0	VT048A015T100FP	100	3.57	26.1
1.2	VT048A015T100FP	100	2.94	32.4
1.5	VT048A015T100FP	100	2.37	39.2
1.8	VT048A020T080FP	80	2.61	35.7
2.0	VT048A020T080FP	80	2.37	39.2
3.0	VT048A030T070FP	70	2.37	39.2
3.3	VT048A040T050FP	50	2.89	32.6
5.0	VT048A060T040FP	40	2.87	33.2
8.0	VT048A080T030FP	30	2.37	32.9
9.6	VT048A096T025FP	25	2.37	32.9
10	VT048A120T025FP	25	2.86	32.9
12	VT048A120T025FP	25	2.37	39.2
15	VT048A160T015FP	15	2.49	37.4
24	VT048A240T012FP	12.5	2.37	39.2
28	VT048A320T009FP	9.4	2.74	35.7
36	VT048A480T006FP	6.3	3.16	30.1
48	VT048A480T006FP	6.3	2.37	39.2

**Note:**

- (1) See Table 2 on page 10 for nominal  $V_{out}$  range and K factors.
- (2) See "PRM output power vs. VTM output power" on Page 11
- (3) 1% precision resistors recommended

**Table 1** — Configure the VI BRICK PRM/VTM for the desired output voltage.

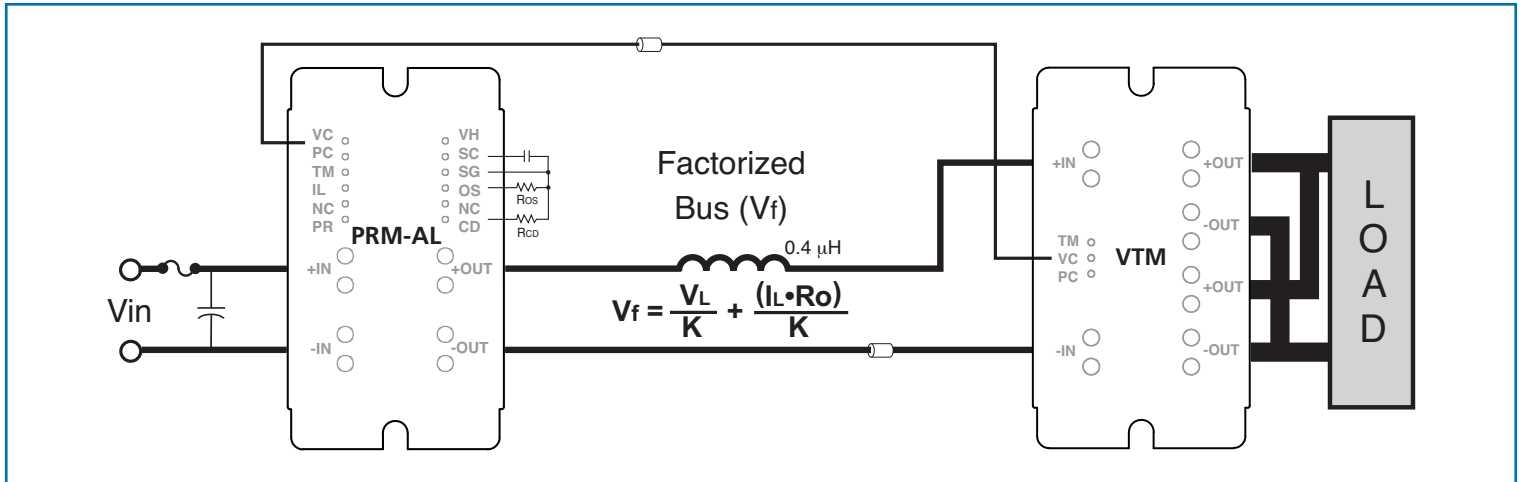

Figure 16 — Adaptive Loop compensation with soft start using the SC port.

### Output Voltage Setting with Adaptive Loop

The equations for calculating  $R_{OS}$  and  $R_{CD}$  to set a VTM output voltage are:

$$R_{OS} = \frac{93100}{\left(\frac{V_L \cdot 0.8395}{K}\right) - 1} \quad (1)$$

$$R_{CD} = \frac{91238}{R_{OS}} + 1 \quad (2)$$

$V_L$  = Desired load voltage

$V_{OUT}$  = VTM output voltage

$K$  = VTM transformation ratio  
(available from appropriate VTM data sheet)

$V_f$  = PRM output voltage, the Factorized Bus (see Figure 16)

$R_O$  = VTM output resistance  
(available from appropriate VTM data sheet)

$I_L$  = Load Current  
(actual current delivered to the load)

### Output Voltage Trimming (optional)

After setting the output voltage from the procedure above the output may be margined down ( $26 V_f \text{ min}$ ) by a resistor from SC-SG using this formula:

$$R_d \Omega = \frac{10000 V_{fd}}{V_{fs} - V_{fd}}$$

Where  $V_{fd}$  is the desired factorized bus and  $V_{fs}$  is the set factorized bus.

A low voltage source can be applied to the SC port to margin the load voltage in proportion to the SC reference voltage.

An external capacitor can be added to the SC port as shown in Figure 16 to control the output voltage slew rate for soft start.

Nominal Vout Range (Vdc)	VTM K Factor
0.8 ↔ 1.6	1/32
1.1 ↔ 2.2	1/24
1.6 ↔ 3.3	1/16
2.2 ↔ 4.4	1/12
3.3 ↔ 6.6	1/8
4.3 ↔ 8.8	1/6
6.5 ↔ 13.4	1/4
8.7 ↔ 17.9	1/3
13.0 ↔ 26.9	1/2
17.4 ↔ 36.0	2/3
26.0 ↔ 54.0	1

Table 2 — 048 input series VTM K factor selection guide

## OVP – Overvoltage Protection

The output Overvoltage Protection set point of the PR045A480T032FP is factory preset for 56 V. If this threshold is exceeded the output shuts down and a restart sequence is initiated, also indicated by PC pulsing. If the condition that causes OVP is still present, the unit will again shut down. This cycle will be repeated until the fault condition is removed. The OVP set point may be set at the factory to meet unique high voltage requirements.

## PRM Output Power Versus VTM Output Power

As shown in Figure 17, the PR045A480T032FP is rated to deliver 6.66 A maximum, when it is delivering an output voltage in the range from 26 V to 48 V, and 320 W, maximum, when delivering an output voltage in the range from 48 V to 55 V. When configuring a PRM for use with a specific VTM, refer to the appropriate VTM data sheet. The VTM input power can be calculated by dividing the VTM output power by the VTM efficiency (available from the VTM data sheet). The input power required by the VTM should not exceed the output power rating of the PRM.

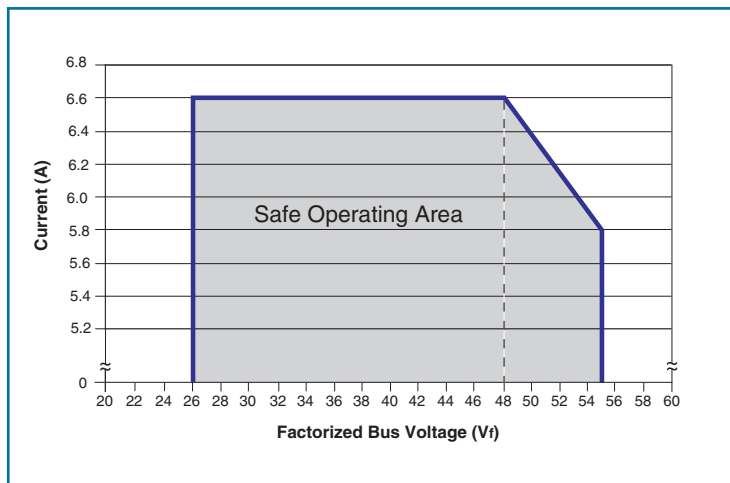

**Figure 17** — PR045A480T032FP rating based on Factorized Bus voltage

The Factorized Bus voltage should not exceed an absolute limit of 55 V, including steady state, ripple and transient conditions. Exceeding this limit may cause the internal OVP set point to be exceeded.

## Parallel Considerations

The PR port is used to connect two PRMs in parallel to form a higher power array. When configuring arrays, PR port interconnection terminating impedance is 10 k to SG. See note Page 8 and refer to Application Note AN002. Additionally one PRM should be designated as the master while all other PRMs are set as slaves by shorting their SC pin to SG. The PC pins must be directly connected (no diodes) to assure a uniform start up sequence. Consult Vicor applications engineering for applications requiring more than two PRMs.

## Adjusting Current Limit

The current limit can be lowered by placing an external resistor between the  $I_L$  and SG ports (see Figure 18 for resistor values). With the  $I_L$  port open-circuit, the current limit is preset to be within the range specified in the output specifications table on Page 4.

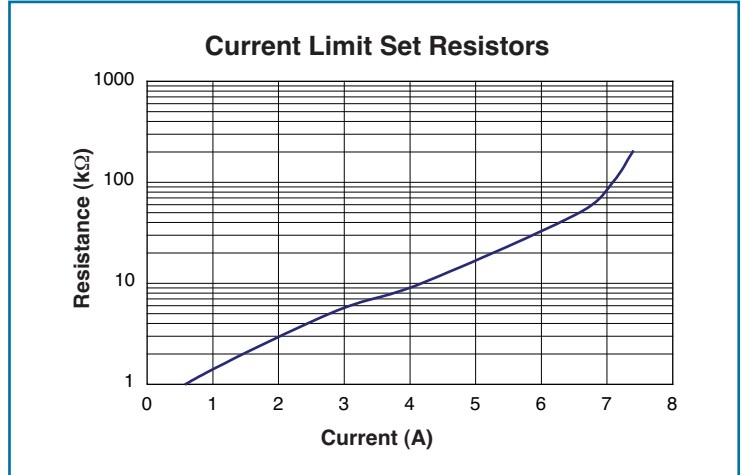

**Figure 18** — Calculated external resistor value for adjusting current limit, actual value may vary.

## Input Fuse Recommendations

A fuse should be incorporated at the input to the PRM, in series with the +In port. A fast acting fuse, NANO2 FUSE 451/453 Series 10 A 125 V, or equivalent, may be required to meet certain safety agency Conditions of Acceptability. Always ascertain and observe the safety, regulatory, or other agency specifications that apply to your specific application. For agency approvals and fusing conditions, click on the link below:

[http://www.vicorpower.com/technical\\_library/technical\\_documentation/quality\\_and\\_certification/safety\\_approvals/](http://www.vicorpower.com/technical_library/technical_documentation/quality_and_certification/safety_approvals/)

## Product Safety Considerations

If the input of the PRM is connected to SELV or ELV circuits, the output of the PRM can be considered SELV or ELV respectively.

If the input of the PRM is connected to a centralized DC power system where the working or float voltage is above SELV, but less than or equal to 75 V, the input and output voltage of the PRM should be classified as a TNV-2 circuit and spaced 1.3 mm from SELV circuitry or accessible conductive parts according to the requirements of UL60950-1, CSA 22.2 60950-1, EN60950-1, and IEC60950-1.

## Application Notes

For PRM and VI BRICK application notes on soldering, board layout, and system design please click on the link below:

[http://www.vicorpower.com/technical\\_library/application\\_information/](http://www.vicorpower.com/technical_library/application_information/)

## Applications Assistance

Please contact Vicor Applications Engineering for assistance, 1-800-927-9474, or email at apps@vicorpower.com.

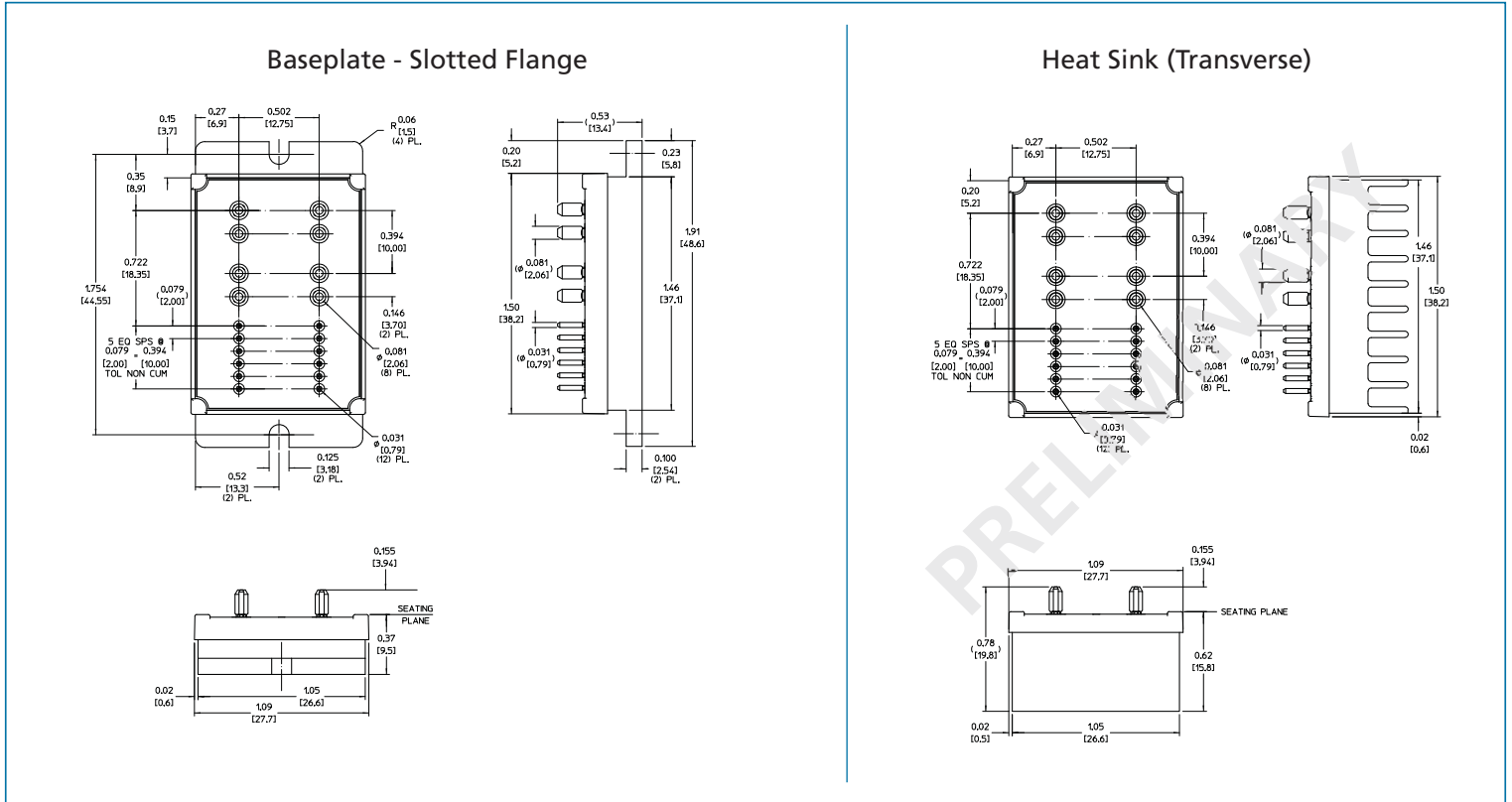

Figure 19 — Module outline

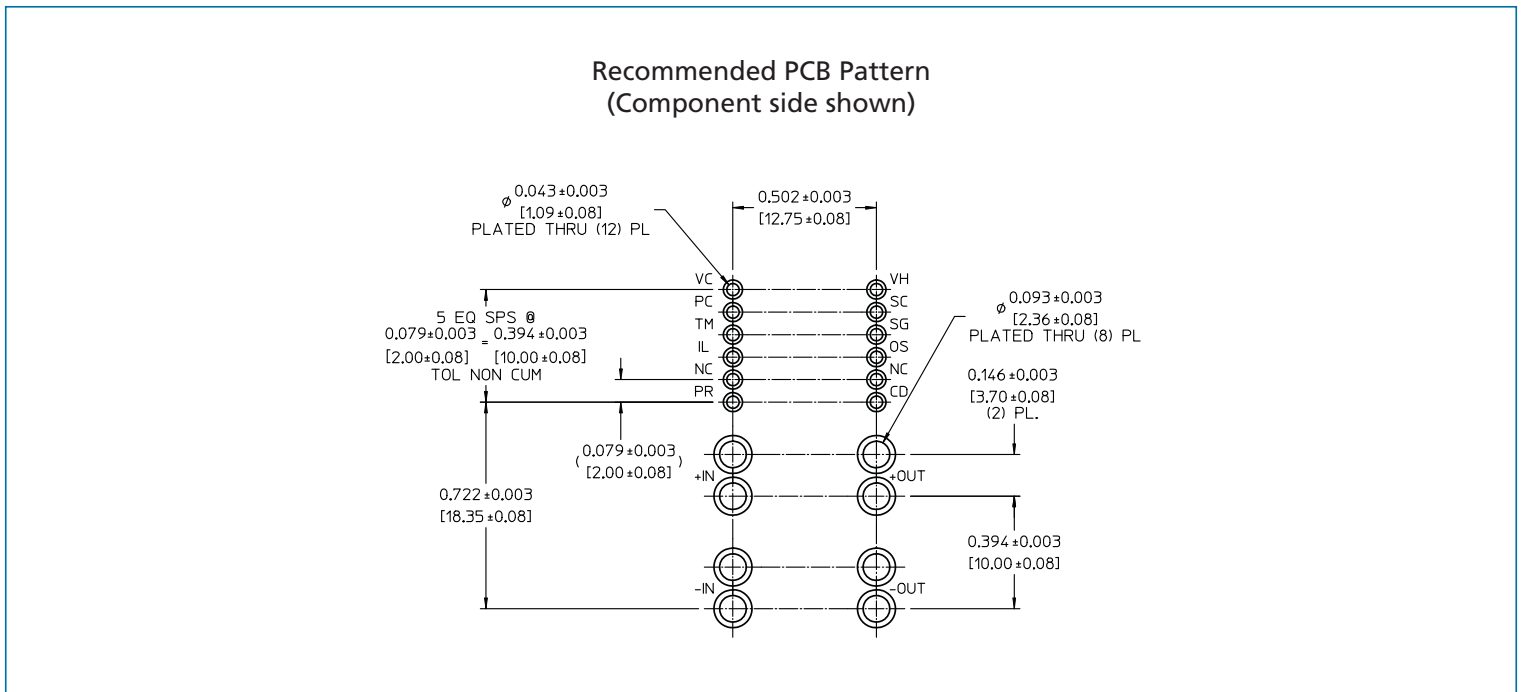

Figure 20 — PCB mounting specifications

## Warranty

Vicor products are guaranteed for two years from date of shipment against defects in material or workmanship when in normal use and service. This warranty does not extend to products subjected to misuse, accident, or improper application or maintenance. Vicor shall not be liable for collateral or consequential damage. This warranty is extended to the original purchaser only.

EXCEPT FOR THE FOREGOING EXPRESS WARRANTY, VICOR MAKES NO WARRANTY, EXPRESS OR IMPLIED, INCLUDING, BUT NOT LIMITED TO, THE WARRANTY OF MERCHANTABILITY OR FITNESS FOR A PARTICULAR PURPOSE.

Vicor will repair or replace defective products in accordance with its own best judgement. For service under this warranty, the buyer must contact Vicor to obtain a Return Material Authorization (RMA) number and shipping instructions. Products returned without prior authorization will be returned to the buyer. The buyer will pay all charges incurred in returning the product to the factory. Vicor will pay all reshipment charges if the product was defective within the terms of this warranty.

Information published by Vicor has been carefully checked and is believed to be accurate; however, no responsibility is assumed for inaccuracies. Vicor reserves the right to make changes to any products without further notice to improve reliability, function, or design. Vicor does not assume any liability arising out of the application or use of any product or circuit; neither does it convey any license under its patent rights nor the rights of others. Vicor general policy does not recommend the use of its components in life support applications wherein a failure or malfunction may directly threaten life or injury. Per Vicor Terms and Conditions of Sale, the user of Vicor components in life support applications assumes all risks of such use and indemnifies Vicor against all damages.

## **Vicor's comprehensive line of power solutions includes high density AC-DC and DC-DC modules and accessory components, fully configurable AC-DC and DC-DC power supplies, and complete custom power systems.**

Information furnished by Vicor is believed to be accurate and reliable. However, no responsibility is assumed by Vicor for its use. Vicor components are not designed to be used in applications, such as life support systems, wherein a failure or malfunction could result in injury or death. All sales are subject to Vicor's Terms and Conditions of Sale, which are available upon request.

## **Specifications are subject to change without notice.**

## **Intellectual Property Notice**

Vicor and its subsidiaries own Intellectual Property (including issued U.S. and Foreign Patents and pending patent applications) relating to the products described in this data sheet. Interested parties should contact Vicor's Intellectual Property Department.

The products described on this data sheet are protected by the following U.S. Patents Numbers:  
5,945,130; 6,403,009; 6,710,257; 6,788,033; 6,940,013; 6,969,909; 7,038,917; 7,154,250; 7,166,898;  
7,187,263; 7,202,646; 7,361,844; 7,368,957; RE40,072; D496,906; D506,438; D509,472; and for use under  
U.S. Pat. Nos. 6,975,098 and 6,984,965

**Vicor Corporation**  
25 Frontage Road  
Andover, MA, USA 01810  
Tel: 800-735-6200  
Fax: 978-475-6715

### **email**

Customer Service: [custserv@vicorpower.com](mailto:custserv@vicorpower.com)  
Technical Support: [apps@vicorpower.com](mailto:apps@vicorpower.com)