

SMD Switching Diode



SMD Diodes Specialist

CDST6-4448TI-G

RoHS Device

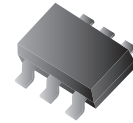

Features

- Fast switching speed.
- Ultra-small surface mount package.
- For general purpose switching applications.
- High conductance power dissipation.

Mechanical data

- Case: SOT-23-6, molded plastic.
- Terminals: Solder plated, solderable per MIL-STD-750, method 2026.
- Mounting position: Any.
- Weight: 0.015 gram (approx.)

Marking: KAA

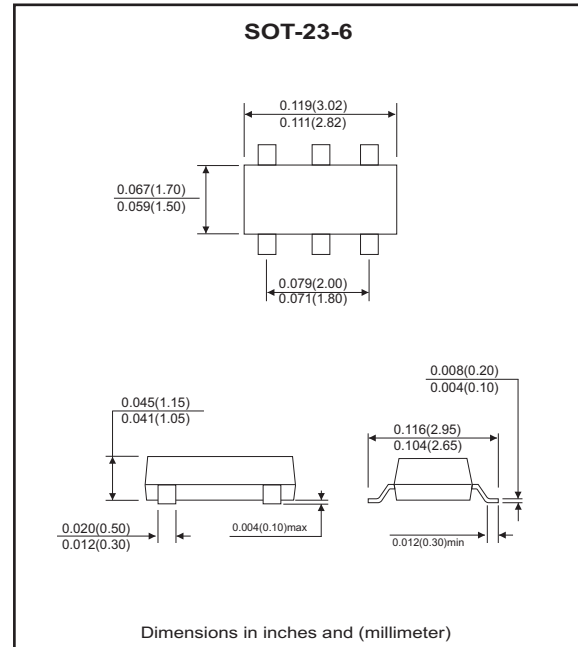
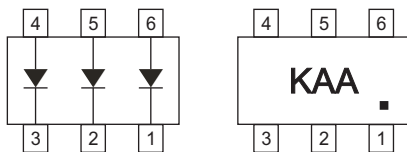

Maximum Ratings (at TA=25°C unless otherwise noted)

Parameter	Symbol	Value	Unit
Non-repetitive peak reverse voltage	V _{RM}	100	V
Peak repetitive reverse voltage	V _{RRM}	75	V
Working peak reverse voltage	V _{RWM}		
DC Blocking voltage	V _R		
RMS Reverse voltage	V _{R(RMS)}	53	V
Forward continuous current	I _{FM}	500	mA
Average rectified output current	I _o	250	mA
Non-repetitive peak forward surge current @ t < 1us @ t < 1s	I _{FSM}	4 2	A
Power dissipation	P _d	200	mW
Thermal resistance junction to ambient air	R _{θJA}	625	°C/W
Operating and storage temperature range	T _j , T _{STG}	-65 to +150	°C

Electrical Characteristics (at TA=25°C unless otherwise noted)

Parameter	Conditions	Symbol	Min	Typ	Max	Unit
Reverse breakdown voltage	I _R = 10uA	V _{BR}	75			V
Forward voltage	I _F = 5mA I _F = 10mA I _F = 50mA I _F = 150mA	V _F	0.62		0.720 0.855 1.0 1.25	V
Reverse current	V _R = 75V V _R = 75V, T _J = 150°C V _R = 25V, T _J = 150°C V _R = 20V	I _R			2.5 50 30 25	uA uA uA nA
Diode junction Capacitance	V _R = 0, f = 1.0MHz	C _J			4.0	pF
Reverse recovery time	I _F = I _R = 10mA I _{rr} = 0.1 x I _R , R _L = 100Ω	T _{rr}			4.0	nS

REV:A

RATING AND CHARACTERISTIC CURVES (CDST6-4448TI-G)

Fig. 1 - Forward characteristics

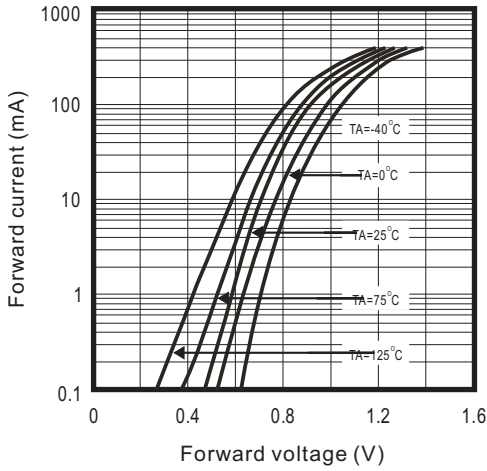

Fig. 2 - Reverse characteristics

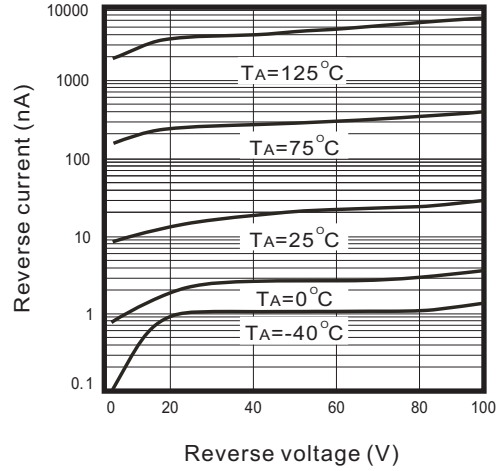

Fig.3 - Capacitance between terminals characteristics

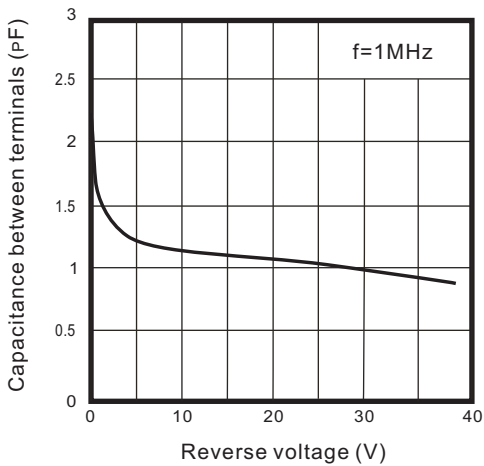

Fig.4 - Power derating curve

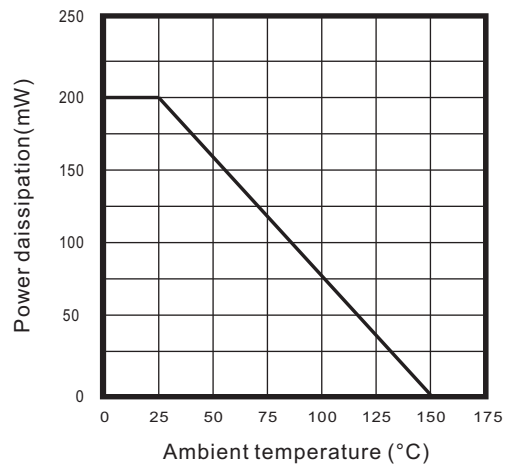
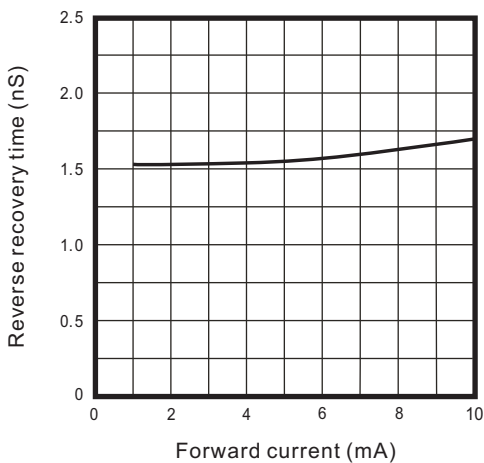
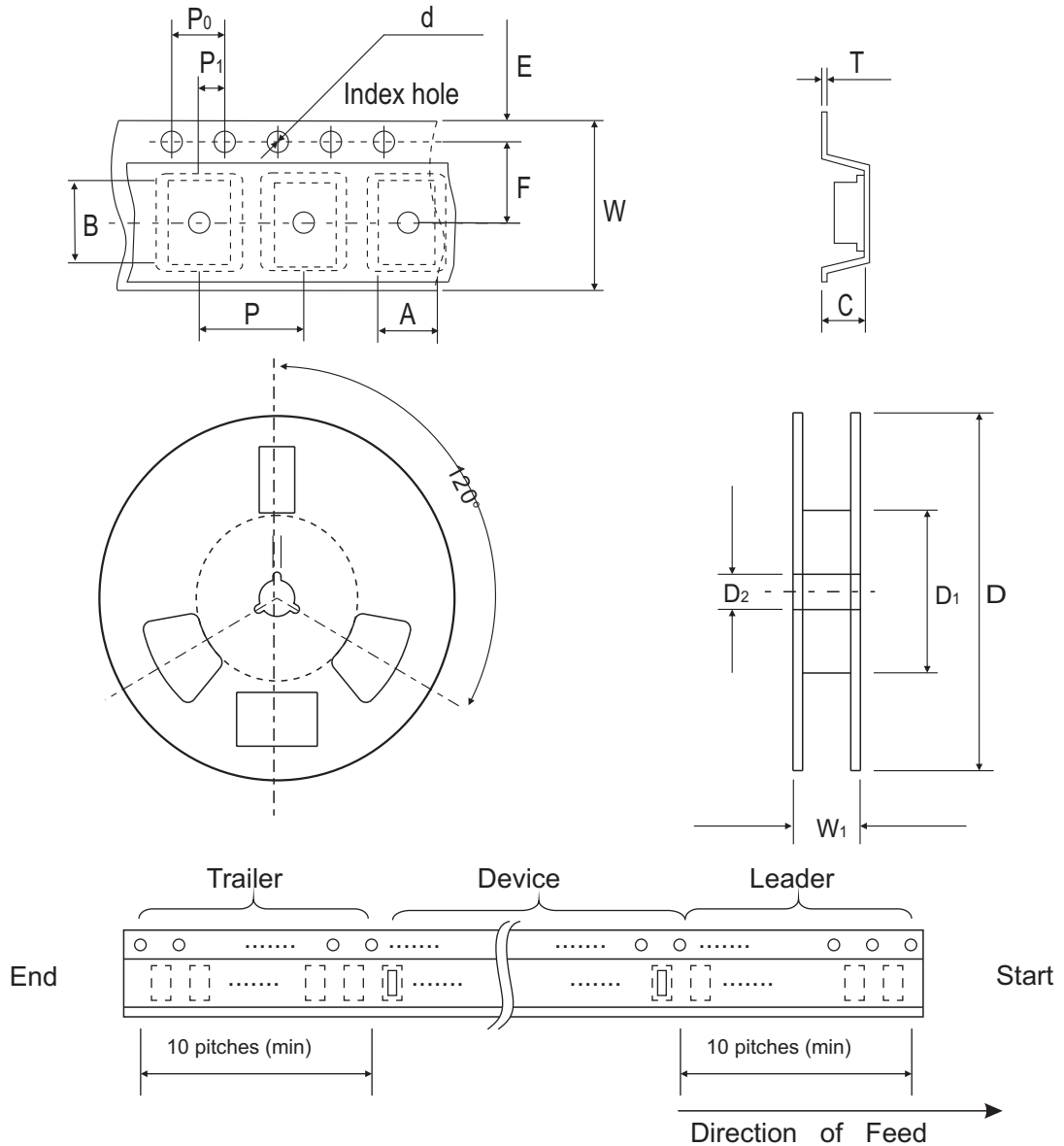

Fig.5 - Reverse recovery time vs. forward current



Reel Taping Specification



SOT-23-6	SYMBOL	A	B	C	d	D	D1	D2
	(mm)	3.17 ± 0.10	3.23 ± 0.10	1.37 ± 0.10	1.55 ± 0.10	178 ± 1	50.0 MIN.	13.0 ± 0.20
	(inch)	0.124 ± 0.004	0.127 ± 0.004	0.054 ± 0.004	0.061 ± 0.004	7.008 ± 0.040	1.969 MIN.	0.512 ± 0.008

SOT-23-6	SYMBOL	E	F	P	P0	P1	W	W1
	(mm)	1.75 ± 0.10	3.50 ± 0.05	4.00 ± 0.10	4.00 ± 0.10	2.00 ± 0.05	8.00 ± 0.30	14.4 MAX.
	(inch)	0.069 ± 0.004	0.138 ± 0.002	0.157 ± 0.004	0.157 ± 0.004	0.079 ± 0.002	0.315 ± 0.012	0.567 MAX

Marking Code

Part Number	Marking Code
CDST6-4448TI-G	KAA

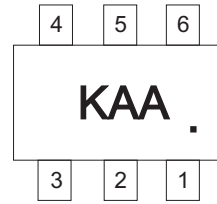

Suggested PAD Layout

SIZE	SOT-23-6	
	(mm)	(inch)
A	1.10	0.043
B	0.60	0.024
C	0.95	0.037
D	2.50	0.098
E	3.60	0.142

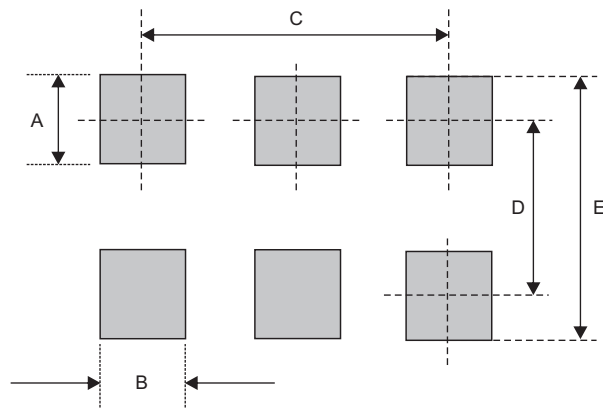

Standard Package

Case Type	Qty per Reel	Reel Size
	(Pcs)	(inch)
SOT-23-6	3000	7